

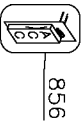

Click Here To View
Item at

www.GapPower.com

*Sales • Rentals
Parts & Service*

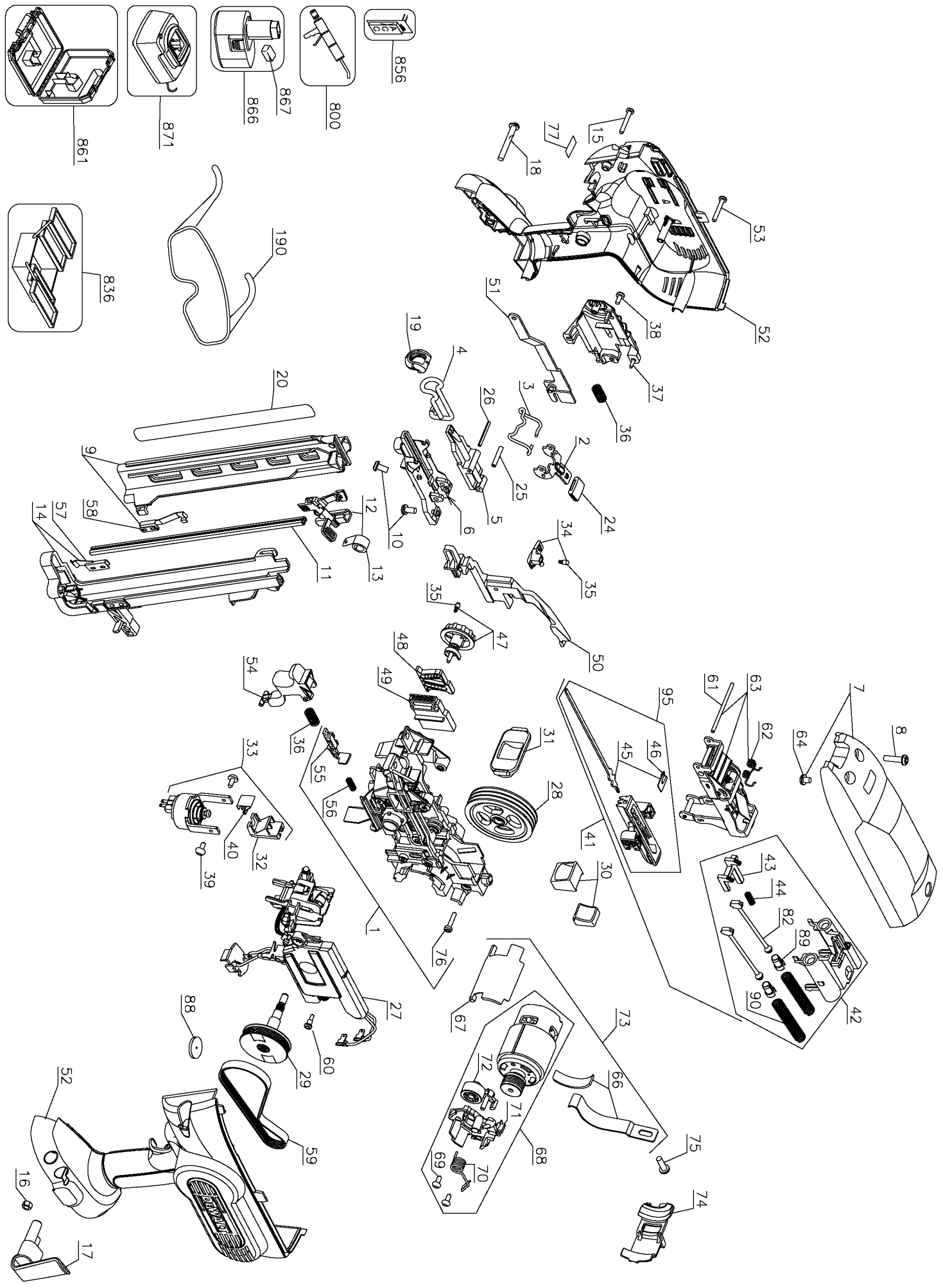

856

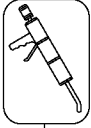

800

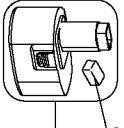

867

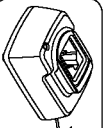

871

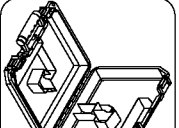

861

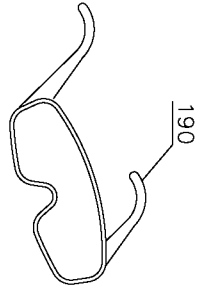

190

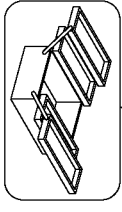

836

Parts List for DC618KA Type 1

Item Number	Part Number	Description	Qty Required
1	613852-00	BACKBONE ASSEMBLY	1
2	395123-00	HANDLE	1
3	392216-00	LATCH	1
4	392198-00	CONTACT TRIP	1
5	392210-00	COVER	1
6	392215-00	NOSEPIECE	1
7	633518-00SV	TOP COVER	1
8	609932-02	SCREW,MACHINE	3
9	392227-00SV	MAGAZINE	1
10	609932-00	SCREW,MACHINE	4
11	392193-00	LINER	1
12	624748-00	PUSHER ASSY.	1
13	392195-00	SPRING	1
14	613818-98	MAGAZINE	1
15	330019-07	SCREW,THD.FORM	1
16	330015-04	NUT,HEX	1
17	394102-00	BELT HOOK	1
18	330045-19	SCREW	2
19	616938-00	NOMAR PAD	1
20	623345-00	NAMEPLATE	1
24	395093-00	COVER/LATCH	1
25	330036-27	ROLL PIN	1
26	330036-21	ROLL PIN	1
27	643115-01	CONTROL MODULE	1
28	623947-00	FLYWHEEL	1
29	613835-00SV	SPINDLE AND PULLEY	1
30	613869-00SV	BUMPER	1

COPYRIGHT© 2005. All Rights Reserved.

Parts list, pricing, and availability subject to change. Please visit www.dewaltservicenetwork.com for current parts information.

Parts List for DC618KA Type 1

Item Number	Part Number	Description	Qty Required
31	392240-00	BUMPER	1
32	392244-00	CLUTCH	1
33	624709-00SV	SOLENOID ASSY.	1
34	N001917SV	PADDLE ASSY.	1
35	326467-00	DETENT	2
36	653099-00	COMPRESSION SPRING	2
37	604480-00	CAGE	1
38	613619-01	SCREW	5
39	330045-60	SCREW,THD.FORM	2
40	621980-00	CLIP,RETAINING	1
41	392230-01SV	RETURN & PROFILE	1
42	393217-00SV	RETURN DEVICE	1
43	614577-00	STOP	1
44	610243-00	SPRING	1
45	624742-00SV	DRIVER BLADE	1
46	392206-00	CLIP	1
47	613874-00	KNOB DEPTH SET	1
48	392437-00	ADJUSTING PLATE	1
49	392438-00	SLIDER	1
50	393220-00SV	CONTACT TRIP	1
51	396657-00	LINKAGE	1
52	399083-00	CLAMSHELL SET	1
53	330019-05	SCREW,PLASTITE	3
54	392197-00	TRIGGER	1
55	392201-00	LINKAGE	1
56	394314-00	COMPR.SPRING	1
57	392252-00	CLIP	1

COPYRIGHT© 2005. All Rights Reserved.

Parts list, pricing, and availability subject to change. Please visit www.dewaltservicenet.com for current parts information.

Parts List for DC618KA Type 1

Item Number	Part Number	Description	Qty Required
58	392229-00	RETAINER	1
59	392246-00	BELT	1
60	623407-00	SHOULDER SCREW	1
61	395932-00	PIVOT PIN	1
62	394045-00	TORSION SPRING	1
63	624717-00SV	ACTUATION ARM	1
64	330045-12	SCREW	1
66	606837-01	MOTOR STRAP	1
67	623181-00	RUBBER PAD	1
68	613834-00SV	MOTOR ASSEMBLY	1
69	330045-44	SCREW	2
70	N044593	SPRING	1
71	397762-00	PLATE	1
72	630664-00SV	IDLER ASSEMBLY	1
73	624740-00	MOTOR ASSEMBLY	1
74	392203-00	MOTOR LEAD WIRE GUIDE	1
75	609932-01	SCREW	1
76	613619-00	SCREW, THD. FORM	5
77	632383-00	LABEL	1
82	392243-00	BAND	2
88	624913-00	DISC	1
89	392242-00	STOP	2
90	392236-02	SPRING	2
95	392204-00SV	PROFILE & DRIVER	1
97	N015432	LIFTER	1
98	N013090	LABEL	1
190	629042-01	SAFETY GLASSES	1

COPYRIGHT© 2005. All Rights Reserved.

Parts list, pricing, and availability subject to change. Please visit www.dewaltservicenetwork.com for current parts information.

Parts List for DC618KA Type 1

Item Number	Part Number	Description	Qty Required
800	5140024-25	GREASE	1
836	000000-00	No Longer Available	1
836	233823-01	SOLENOID PULLER	1
836	233823-00	GAP GAUGE	1
856	625336-01	DIAGNOSTICS CD	1
856	625336-00	DIAGNOSTICS CD	1
861	633527-00	KITBOX	1
861	623488-00	LID CARD	1
866	DC9096	BATTERY PACK	2
867	645221-00	BATTERY CAP	1
871	388683-12	1 HOUR CHARGER	1

COPYRIGHT© 2005. All Rights Reserved.

Parts list, pricing, and availability subject to change. Please visit www.dewaltservicenet.com for current parts information.