

REBAR TYING TOOL  
OUTIL DE LIGATURE DE BARRES  
ATADORA DE ARMADURAS DE REFUERZO

**MAX**

**RE·BAR·TIER**

**RB441T(CE)**

INSTRUCTION MANUAL AND SAFETY INSTRUCTIONS  
MODE D'EMPLOI ET CONSIGNES DE SÉCURITÉ  
MANUAL DE INSTRUCCIONES E INSTRUCCIONES DE SEGURIDAD

**TYINTIER**



INDEX	ENGLISH	Page	2	to	17
SOMMAIRE	FRANÇAIS	Page	18	à	32
ÍNDICE	ESPAÑOL	Página	33	a	48



**WARNING**

Before using the tool, read and understand tool labels and manual. Failure to follow warnings could result in serious injury. Keep these instructions with the tool for future reference.



**AVERTISSEMENT**

Veillez à lire et bien comprendre les étiquettes et le manuel avant d'utiliser cet outil. Tout manquement au respect des avertissements peut entraîner des blessures graves. Conservez ces instructions avec l'outil pour toute consultation ultérieure.



**ADVERTENCIA**

Lea y comprenda las etiquetas y el manual de la herramienta antes de usarla. El incumplimiento de las advertencias puede provocar lesiones graves. Conserve estas instrucciones junto con la herramienta para futuras consultas.

Fig.1

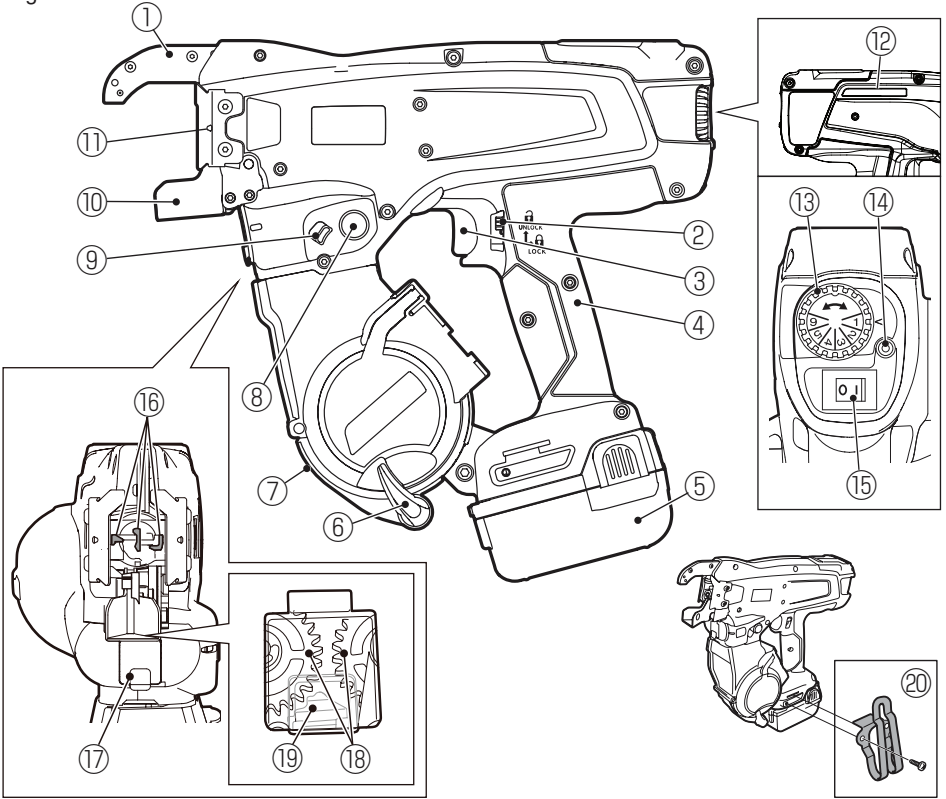

Fig.2

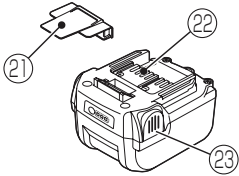

Fig.3

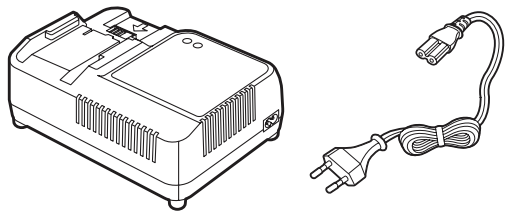

Fig.4

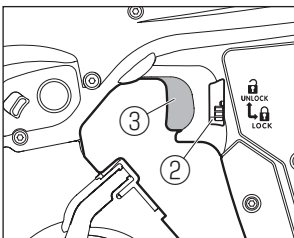

Fig.5

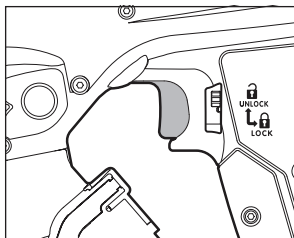

Fig.6

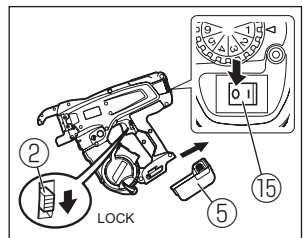

Fig.7

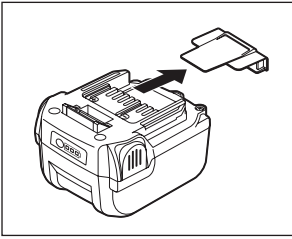

Fig.8

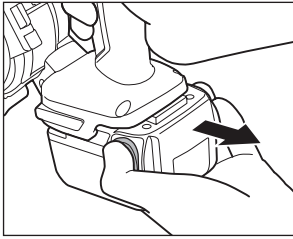

Fig.9

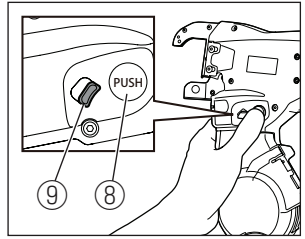

Fig.10

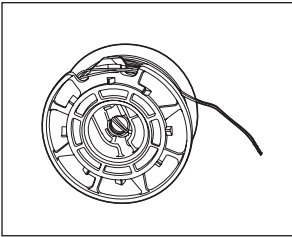

Fig.11

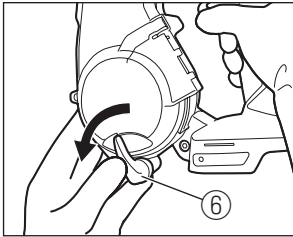

Fig.12

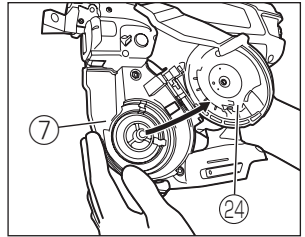

Fig.13

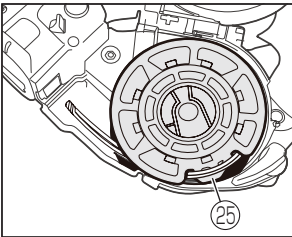

Fig.14

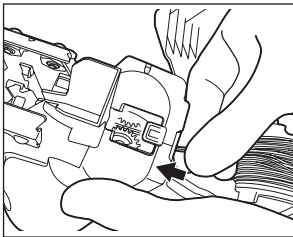

Fig.15

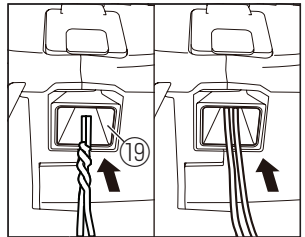

Fig.16

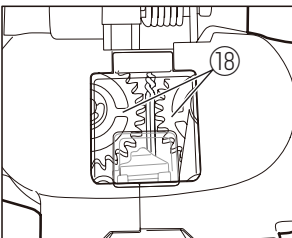

Fig.17

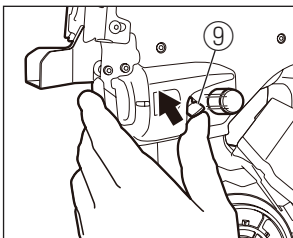

Fig.18

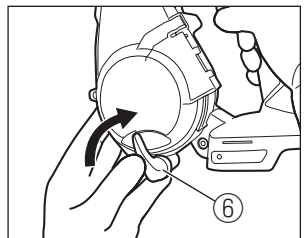

Fig.19

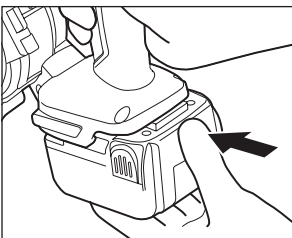

Fig.20

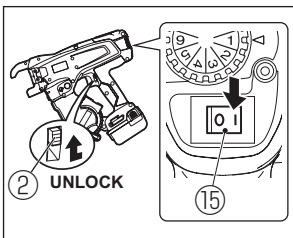

Fig.21

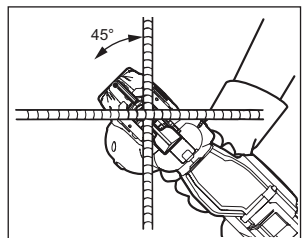

Fig.22

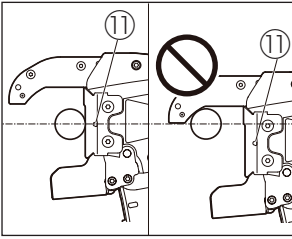

Fig.23

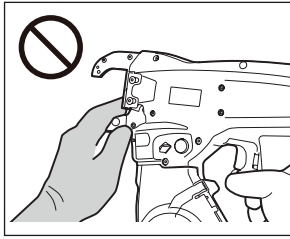

Fig.24

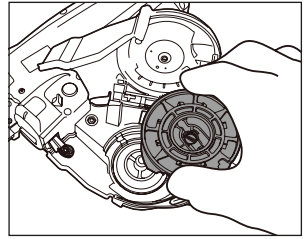

Fig.25

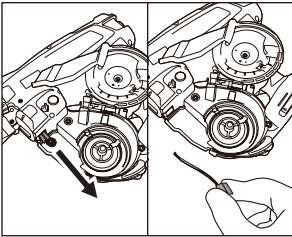

Fig.26

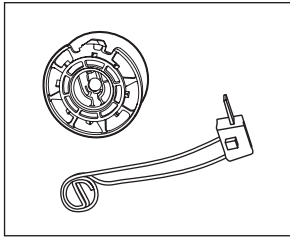

Fig.27

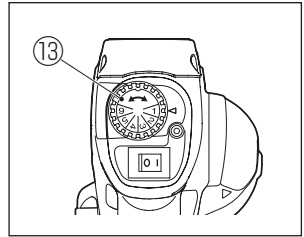

Fig.28

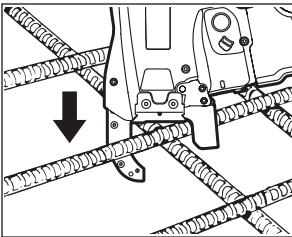

Fig.29

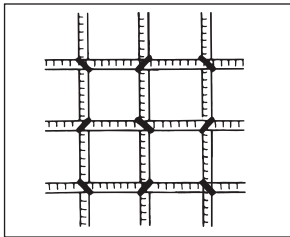

Fig.30

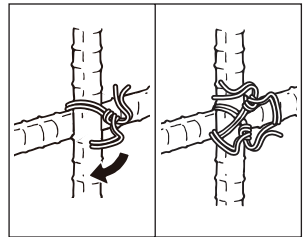
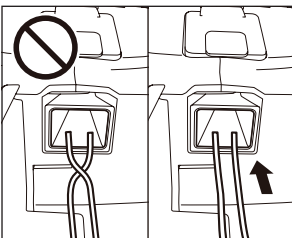

Fig.31



**INSTRUCTION MANUAL AND SAFETY INSTRUCTIONS**

**INDEX**

1. NAME OF PARTS..... 6  
2. LIST OF CONTENTS ..... 6  
3. GENERAL POWER TOOL SAFETY WARNINGS ..... 7  
4. RB441T SAFETY FEATURES..... 9  
5. TOOL SPECIFICATIONS AND TECHNICAL DATA..... 11  
6. TECHNICAL DATA..... 12  
7. PRODUCTION YEAR ..... 12  
8. WIRE SPECIFICATION ..... 13  
9. APPLICATIONS..... 13  
10. APPLICABLE REBAR SIZE ..... 13  
11. BATTERY INSTRUCTIONS..... 14  
12. OPERATING INSTRUCTIONS ..... 15  
13. STORAGE..... 16  
14. WARNING BUZZERS AND PROCEDURES TO FOLLOW ..... 17

**DEFINITIONS OF SIGNAL WORDS**

- WARNING:** Indicates a hazardous situation which, if not avoided, could result in death or serious injury.
- CAUTION:** Indicates a hazardous situation which, if not avoided, could result in minor or moderate injury.
- NOTICE:** Indicates a property damage message.

# 1. NAME OF PARTS

## Fig.1

- |                    |                   |                               |
|--------------------|-------------------|-------------------------------|
| ① Arm              | ⑧ Release button  | ⑮ Main switch                 |
| ② Trigger lock     | ⑨ Release stopper | ⑯ Hook                        |
| ③ Trigger          | ⑩ Curl guide      | ⑰ Window                      |
| ④ Grip             | ⑪ Center mark     | ⑱ Feeding gear                |
| ⑤ Battery pack     | ⑫ Serial number   | ⑲ Wire guide                  |
| ⑥ Magazine stopper | ⑬ Torque dial     | ⑳ Belt hook (sold separately) |
| ⑦ Magazine         | ⑭ LED             |                               |

## Fig.2

- ⑳ Pack cap
- ㉑ Terminal
- ㉒ Latch

## Fig.3

Refer to the JC925 operating and maintenance manual.

## Fig.12

- ㉔ Magazine cover

## Fig.13

- ㉕ Holding slot

# 2. LIST OF CONTENTS

- MAX Rebar Tying tool / RB441T(CE)
- Lithium ion Battery pack / JPL91440A
- Lithium ion Battery charger / JC925(CE)
- Power cord
- INSTRUCTION MANUAL AND SAFETY INSTRUCTIONS (This book)

### 3. GENERAL POWER TOOL SAFETY WARNINGS



#### WARNING

#### READ ALL SAFETY WARNINGS AND ALL INSTRUCTIONS.

Failure to follow the warnings and instructions may result in electric shock, fire and/or serious injury. **Save all warnings and instructions for future reference.** The term "power tool" in the warnings refers to your mains-operated (corded) power tool or battery-operated (cordless) power tool.

#### 1. WORK AREA SAFETY

- **Keep work area clean and well lit.** Cluttered or dark areas invite accidents.
- **Do not operate power tools in explosive atmospheres, such as in the presence of flammable liquids, gases or dust.** Power tools create sparks which may ignite the dust or fumes.
- **Keep children and bystanders away while operating a power tool.** Distractions can cause you to lose control.

#### 2. ELECTRICAL SAFETY

- **Power tool plugs must match the outlet. Never modify the plug in any way. Do not use any adapter plugs with earthed (grounded) power tools.** Unmodified plugs and matching outlets will reduce risk of electric shock.
- **Avoid body contact with earthed or grounded surfaces, such as pipes, radiators, ranges and refrigerators.** There is an increased risk of electric shock if your body is earthed or grounded.
- **Do not expose power tools to rain or wet conditions.** Water entering a power tool will increase the risk of electric shock.
- **Do not abuse the cord. Never use the cord for carrying, pulling or unplugging the power tool. Keep cord away from heat, oil, sharp edges or moving parts.** Damaged or entangled cords increase the risk of electric shock.
- **When operating a power tool outdoors, use an extension cord suitable for outdoor use.** Use of a cord suitable for

outdoor use reduces the risk of electric shock.

- **If operating a power tool in a damp location is unavoidable, use a residual current device (RCD) protected supply.** Use of an RCD reduces the risk of electric shock.

#### 3. PERSONAL SAFETY

- **Stay alert, watch what you are doing and use common sense when operating a power tool. Do not use a power tool while you are tired or under the influence of drugs, alcohol or medication.** A moment of inattention while operating power tools may result in serious personal injury.
- **Use personal protective equipment. Always wear eye protection.** Protective equipment such as dust mask, non-skid safety shoes, hard hat, or hearing protection used for appropriate conditions will reduce personal injuries.
- **Prevent unintentional starting. Ensure the switch is in the off-position before connecting to power source and/or battery pack, picking up or carrying the tool.** Carrying power tools with your finger on the switch or energising power tools that have the switch on invites accidents.
- **Remove any adjusting key or wrench before turning the power tool on.** A wrench or a key left attached to a rotating part of the power tool may result in personal injury.
- **Do not overreach. Keep proper footing and balance at all times.** This enables better control of the power tool in unexpected situations.
- **Dress properly. Do not wear loose clothing or jewelry. Keep your hair, clothing and gloves away from moving parts.** Loose clothes, jewelry or long hair can be caught in moving parts.
- **If devices are provided for the connection of dust extraction and collection facilities, ensure these are connected and properly used.** Use of dust collection can reduce dust-related hazards.

#### 4. POWER TOOL USE AND CARE

- **Do not force the power tool. Use the correct power tool for your application.** The correct power tool will do the job better and safer at the rate for which it was designed.

- **Do not use the power tool if the switch does not turn it on and off.** Any power tool that cannot be controlled with the switch is dangerous and must be repaired.
- **Disconnect the plug from the power source and/or the battery pack from the power tool before making any adjustments, changing accessories, or storing power tools.** Such preventive safety measures reduce the risk of starting the power tool accidentally.
- **Store idle power tools out of the reach of children and do not allow persons unfamiliar with the power tool or these instructions to operate the power tool.** Power tools are dangerous in the hands of untrained users.
- **Maintain power tools. Check for misalignment or binding of moving parts, breakage of parts and any other condition that may affect the power tool's operation. If damaged, have the power tool repaired before use.** Many accidents are caused by poorly maintained power tools.
- **Keep cutting tools sharp and clean.** Properly maintained cutting tools with sharp cutting edges are less likely to bind and are easier to control.
- **Use the power tool, accessories and tool bits etc. in accordance with these instructions, taking into account the working conditions and the work to be performed.** Use of the power tool for operations different from those intended could result in a hazardous situation.

## 5. BATTERY TOOL USE AND CARE

- **Recharge only with the charger specified by the manufacturer.** A charger that is suitable for one type of battery pack may create a risk of fire when used with another battery pack.
- **Use power tools only with specifically designated battery packs.** Use of any other battery packs may create a risk of injury and fire.
- **When battery pack is not in use, keep it away from other metal objects, like paper clips, coins, keys, nails, screws or other small metal objects, that can make a connection from one terminal to another.** Shorting the battery terminals together may cause burns or a fire.

- **Under abusive conditions, liquid may be ejected from the battery; avoid contact. If contact accidentally occurs, flush with water. If liquid contacts eyes, additionally seek medical help.** Liquid ejected from the battery may cause irritation or burns.

## 6. SERVICE

- **Have your power tool serviced by a qualified repair person using only identical replacement parts.** This will ensure that the safety of the power tool is maintained.

- 
- **Do not use the power tool in the rain, where water is splashing, in a wet place, or in a damp place.** Using the tool in these or similar conditions will increase the risk of electric shock, dangerous malfunction, and overheating.
  - **DO NOT DISPOSE OF BATTERY PACKS/ BATTERIES INTO FIRE OR WATER.** Battery packs/batteries should be collected, recycled or disposed of in an environmental-friendly manner.
  - **PROTECT THE BATTERY AGAINST HEAT, ALSO AGAINST CONTINUOUS SUN IRRADIATION AND FIRE.** There is danger of explosion.
  - **CHARGE THE BATTERY PACK IN A TEMPERATURE RANGE 5°C (41°F) TO 40°C (104°F).**



- **DO NOT DISPOSE OF POWER TOOLS INTO HOUSEHOLD WASTE.** According to the European Guideline 2002/96/EC for Waste Electrical and Electronic Equipment and its implementation into national right, power tools that are no longer usable must be collected separately and disposed of in an environmentally correct manner.
- **DEFECTIVE OR DEAD OUT BATTERY PACKS/BATTERIES MUST BE RECYCLED ACCORDING TO THE GUIDELINE 2006/66/EC.**



## 4. RB441T SAFETY FEATURES

### 1. INSPECT THE PARTS BEFORE MOUNTING THE BATTERY PACK

- Examine the screws to make sure they are securely tightened.  
Incomplete tightening may result in an accident or breakage. If a screw is loose, retighten it completely.
- Inspect parts for damage.  
Parts will wear over periods of use. Look also for missing and defective parts and for parts of poor quality. If a part must be replaced or repaired, purchase the replacement part at the dealer where the tool was purchased or MAX CO., LTD. authorized distributors.  
Use only genuine authorized replacement parts.

### 2. SET THE MAIN SWITCH (FIG.6.⑮) AT "OFF", THE TRIGGER LOCK (FIG.6.②) AT "LOCK" AND REMOVE THE BATTERY PACK (FIG.6.⑤), WHEN CHANGING THE BATTERY PACK, REPLACING OR ADJUSTING THE TIEWIRE, ABNORMALITIES OCCUR, AND THE TOOL IS NOT BEING USED

Leaving the tool switched on in these situations may cause breakdowns or damage.

### 3. KEEP FINGERS AND BODY PARTS CLEAR BETWEEN THE ARM AND CURL GUIDE AT ALL TIMES (FIG.23)

Failure to do so may result in serious injury.

### 4. KEEP FINGERS AND BODY PARTS AWAY FROM THE TIEWIRE WHEN TOOL IS IN OPERATION

Failure to do so may result in serious injury.

### 5. DO NOT POINT THE TOOL AT ANYONE

Personal injury may result if the tool catches an operator or anyone working near him/her. While working with the tool, be extremely careful not to bring hands, legs, and other body parts near the arm of the tool.

### 6. WHEN THE TOOL IS NOT IN OPERATION KEEP YOUR FINGERS OFF THE TRIGGER

Failure to do so may cause accidental tying, leading to serious injury.

### 7. NEVER OPERATE THE TOOL UNDER ANY ABNORMAL CONDITION

If the tool is not in good working order, or if any abnormal condition is noticed, switch it off immediately (set the Main switch at "OFF"), lock the Trigger and have it examined and repaired.

### 8. AFTER BATTERY INSTALLATION IF THE TOOL OPERATES WITHOUT THE TRIGGER BEING PULLED OR THE OPERATOR NOTICES UNUSUAL HEAT, SMELL, OR SOUND, DISCONTINUE OPERATION

Failure to do so may lead to serious injury. Return to dealer for safety inspection.

### 9. NEVER MODIFY THE TOOL

Modifying the tool will impair performance and operating safety. Any modification may lead to serious injury and void the tool warranty.

### 10. MAINTAIN THE TOOL IN GOOD OPERATING CONDITION

To secure operating safety and ensure top performance, keep the tool free of wear and damage. Also keep the tool's hand grip dry and clean, especially free of oil and grease.

### 11. USE ONLY THE AUTHORIZED BATTERY PACK

If the tool is connected to a power supply other than the authorized pack, such as a rechargeable battery, a dry cell, or a storage battery for use in automobiles, the tool may be damaged, break down, overheat, or even catch on fire. Do not connect this tool to any power supply except the authorized battery pack.

### 12. TO ENSURE MAXIMUM PERFORMANCE, FULLY CHARGE THE BATTERY BEFORE USE

A new battery pack or one not used for extended periods may have self-discharged and thus may need recharging to restore it to a fully charged condition. Before operating the tool, make sure to charge the Battery pack with the designated MAX Battery charger.

### 13. BATTERY CHARGING PRECAUTION

#### 13-1 Use only MAX Battery charger and MAX Battery pack.

Failure to do so may cause the Battery to overheat or catch fire leading to serious injury.

**13-2 Charge the Battery from AC between 220V and 240V wall sockets.**

Failure to do so may result in overheating, or inadequate charging possibly causing serious injury.

**13-3 Never use a transformer.**

**13-4 Never connect the Battery charger to an engine generator direct-current power supply.**

The charger will break down or be damaged from burning.

**13-5 Avoid charging the Battery pack in the rain, in a damp place, or where water is splashing.**

Charging a damp or wet Battery pack will cause an electric shock or a short circuit that may lead to damage from burning and even the tool catching on fire.

**13-6 Do not touch the power cord or plug with a wet hand or glove.**

This may cause injury from electric shock.

**13-7 Do not put a cloth or any other cover on the Battery charger while the Battery pack is being charged.**

This will cause overheating and damage from burning, or the Charger may even catch fire.

**13-8 Keep the Battery pack and Battery charger away from heat and flames.**

**13-9 Do not charge the Battery pack near flammable materials.**

**13-10 Charge the Battery pack in a well ventilated place.**

Avoid charging the Battery pack where it will be in direct sunlight.

**13-11 Charge the Battery pack in a temperature range of 5°C (41°F) to 40°C (104°F).**

**13-12 Avoid continual use of the Battery charger.**

Rest the Charger for 15 minutes between charges to avoid functional trouble with the unit.

**13-13 Any objects that block the ventilation holes or Battery pack receptacle may cause electric shock or functional troubles.**

Operate the charger free of dust or other foreign materials.

**13-14 Handle the power cord carefully.**

Do not carry the Battery charger by its power cord. Do not use the power cord to disconnect it from a wall socket; this will damage the cord and break the wires or cause a short circuit. Do not let the power cord contact sharp edged tools, hot materials, oil, or grease. A damaged cord must be repaired or replaced.

**13-15 Do not charge non rechargeable batteries with this charger.**

**13-16 This charger is not intended for use by children or disabled persons without supervisor.**

**13-17 Children should be supervised to ensure that they do not play with the charger.**

**13-18 Put a Pack cap (Fig.2.⑴) on the Terminal (Fig.2.⑵) of the Battery pack.**

When the Battery pack is not in use, put a Pack cap on its Terminal to prevent short circuits.

**13-19 Do not let the Terminal (metal component) of the Battery pack short-circuit.**

A short circuit in the Terminal will generate a large current, causing to overheat the Battery pack and become damaged.

**13-20 Do not leave or store the tool in a vehicle or in direct sunlight during summer. Leaving the tool in high temperature conditions may cause the Battery pack to deteriorate.**

**13-21 Do not store a fully discharged Battery pack. If a fully discharged Battery pack is removed from the system and left for a long period of time, it may become damaged. Recharge the battery immediately when it has been discharged.**

**14. WEAR SAFETY GLOVES WHILE OPERATING THE TOOL**

The finish tie has sharp edges. To avoid serious injuries, be careful not to touch the sharp edges.

**15. PRIOR TO USING THE TOOL**

(Fig.4 and 5) Make sure that the safety features function properly. If they do not, avoid using the tool.

## 5. TOOL SPECIFICATIONS AND TECHNICAL DATA

<b>PRODUCT DESCRIPTION</b>	MAX Rebar Tying tool "TWINTIER"
<b>PRODUCT NO.</b>	RB441T(CE)
<b>DIMENSIONS (Battery pack included)</b>	(H)295mm x (W)120mm x (L)330mm
<b>WEIGHT (Battery pack included)</b>	2.5kg / 5.6lbs
<b>BATTERY</b>	Lithium ion Battery pack / JPL91440A
<b>OPERATING TEMPERATURE</b>	-10°C to 40°C / 14°F to 104°F
<b>HUMIDITY</b>	80% RH or less

### <BATTERY CHARGER>

<b>PRODUCT DESCRIPTION</b>	Lithium ion Battery charger
<b>PRODUCT NO.</b>	JC925(CE)
<b>INPUT</b>	AC220-240V 50/60Hz 1.4A 160W
<b>OUTPUT</b>	DC14.4V 7.5A, DC18V 5.4A, DC25.2V 4.5A
<b>WEIGHT</b>	1.5kg / 3.3lbs
<b>OPERATING TEMPERATURE RANGE</b>	5°C to 40°C / 41°F to 104°F
<b>OPERATING HUMIDITY RANGE</b>	80% RH or less

### <BATTERY PACK>

<b>PRODUCT DESCRIPTION</b>	Lithium ion Battery pack
<b>PRODUCT NO.</b>	JPL91440A
<b>NOMINAL VOLTAGE</b>	DC14.4V(3.6V x 4cells)
<b>NOMINAL CAPACITY</b>	3.9Ah (3,900mAh)
<b>CHARGING TIME</b>	Quick charging – Approx. 33min.(Approx. 90% of capacity) Full charging – Approx. 45min.(100% of capacity)
<b>ACCESSORIES</b>	Pack cap
<b>WEIGHT</b>	0.5kg / 1.1lbs
<b>CHARGING TEMPERATURE</b>	5°C to 40°C / 41°F to 104°F
<b>OPERATINGTEMPERATURE RANGE</b>	0°C to 40°C / 32°F to 104°F
<b>OPERATING HUMIDITY RANGE</b>	80% RH or less

<b>TIES PER CHARGE</b>	Approx. 4,000 ties (*under the following conditions: normal temperature, unused, full-charged battery and 13mm x 13mm / #4 x #4 rebars)
------------------------	---

## 6. TECHNICAL DATA

### 6-1 NOISE

Measured value according to EN 60745:

A-weighted sound pressure level (LpA): 79 dB

Uncertainty (KpA): 3dB

A-weighted sound power level (LWA): 79 dB

Uncertainty (KWA): 3dB

### 6-2 VIBRATION

Measured value according to EN 60745:

Vibration total values (ah): 0.5 m/s<sup>2</sup>

Uncertainty (K): 0.1 m/s<sup>2</sup>

- The declared vibration emission value has been measured in accordance with the standard test method and may be used for comparing one tool with another.
- The declared vibration emission value may also be used in a preliminary assessment of exposure.



#### WARNING

- The vibration emission during actual use of the power tool can differ from the declared emission value depending on the ways in which the tool is used.
- Be sure to identify safety measures to protect the operator that are based on an estimation of exposure in the actual conditions of use (taking account of all parts of the operating cycle such as the times when the tool is switched off and when it is running idle in addition to the trigger time).

### 6-3 RADIATED EMISSION 30-1000 MHZ Class A



#### WARNING

This is a class A product. In a domestic environment this product may cause radio interference in which case the user may be required to take adequate measures.

6-4 Overvoltage category - category 1 according to IEC 60664-1

6-5 Pollution degree - degree 4 according to IEC 60664-1

6-6 Design guidelines – Machinery directive annex 1, EN60745-1, EN60745-2-18

## 7. PRODUCTION YEAR

This product bears production number in the body (Fig.1.⑫). The two digits of the number from left indicates the production year.

(Example)

17526035D

T

Year 2017

## 8. WIRE SPECIFICATION

TIEWIRE		TW1061T	TW1061T-PC	TW1061T-EG
TYPE OF WIRE		Annealed wire	Poly-coated wire	Electro-galvanized wire
DIAMETER		1.0mm	1.1mm	1.0mm
TIES/COIL	10 mm × 10 mm / #3 × #3	Approx. 265 ties	Approx. 230 ties	Approx. 265 ties
	13 mm × 13 mm / #4 × #4	Approx. 240 ties	Approx. 210 ties	Approx. 240 ties
	22 mm × 16 mm × 16 mm / #7 × #5 × #5	Approx. 170 ties	Approx. 150 ties	Approx. 170 ties

\*RB441T is not compatible with TW898 series or TW1525 series.

## 9. APPLICATIONS

- Precast concrete panel
- Building foundation
- Commercial building
- Road & Bridge
- Floor heating pipe

## 10. APPLICABLE REBAR SIZE

### ■ 2 rebars combination



Minimum	Maximum
10mm × 10mm / #3 × #3	22mm × 22mm / #7 × #7 25mm × 19mm / #8 × #6

### ■ 3 rebars combination



Minimum	Maximum
10mm × 10mm × 10mm / #3 × #3 × #3	22mm × 16mm × 16mm / #7 × #5 × #5 25mm × 13mm × 13mm / #8 × #4 × #4

### ■ 4 rebars combination





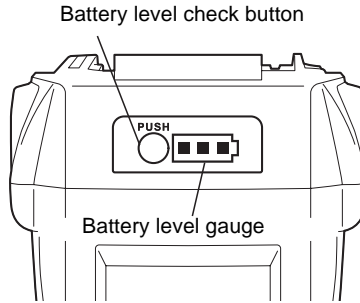

Minimum	Maximum
10mm × 10mm × 10mm × 10mm / #3 × #3 × #3 × #3	16mm × 16mm × 13mm × 13mm / #5 × #5 × #4 × #4

# 11.BATTERY INSTRUCTIONS

## About the Battery Level Indicator



- (1) To check the battery level (excluding while charging or while operating the charging tool), press the Battery level check button.
- (2) The Battery level gauge is on according to the battery level.

	Battery level: 0%	Battery level: about 0 to 10%	Battery level: about 10 to 40%	Battery level: about 40 to 70%	Battery level: about 70 to 100%
Battery level gauge	 All indicators OFF	 One red indicator blinks	 One red indicator ON	 Two red indicators ON	 Three red indicators ON

## Service Life of the Battery pack

If any condition described below is observed, the Battery pack is at the end of its service life. Replace it with a new one.

Although the Battery pack has been properly charged (fully charged), a great drop in tying time has been noticed.

### NOTICE

- Do not charge the Battery pack when this happens. If the motor's rotational speed slows down, the power of the Battery pack is considered to be nearly depleted. Using the tool more will cause it to overdischarge, resulting in a shortened service life of the Battery pack and also in functional trouble of the tool's main body.
- Do not use a Battery pack when its service life is finished. This will cause functional trouble in the tool's main body. Also charging a Battery pack that is out of service life will lead to functional trouble in the Charger.

## Recycling a Li-ion Battery

The MAX battery pack uses a Li-ion battery, it may be illegal to dispose of this Battery into the municipal waste system. Check with your local solid waste officials for details in your area for recycling options or proper disposal.



### CAUTION

When disposing of the Battery pack, make sure to put a Pack cap on its Terminal (with insulating tape securing it) to prevent short circuits.

## 12. OPERATING INSTRUCTIONS

### 1. How to set the Tiewire

(Fig.6) Set the Main switch (15) at "OFF", the Trigger lock (2) at "LOCK" and remove the Battery pack (5).



#### CAUTION

- Be careful not to drop or give a strong impact to the Tiewire. It may cause the damage and the malfunction of the tool.
- Beware of the tip of the wire when you pick up the Tiewire. It might cause an injury.

1-1 (Fig.9) Press the Release button (8) of this tool, and confirm that the Release button is caught in the Release stopper (9).

1-2 (Fig.10) Stretch out the tip of the wound Tiewire.

#### BE SURE TO USE ONLY THE SPECIFIED TIEWIRE (MAX TW1061T Series).

The use of binding wire that has not been specified may cause breakdown of this tool. Therefore, be sure only to use the specified MAX TW1061T series. RB441T is not compatible with TW898 series or TW1525 series.

#### DO NOT USE RUSTY WIRE.

The use of the rusty wire may cause functional trouble of the tool.

1-3 (Fig.11) Rotate the Magazine stopper (6) 45° counterclockwise.

1-4 (Fig.12,13) Open the Magazine cover (24) and set the Tiewire in the Magazine (7) with the Holding slot (23) side of the reel facing up.

1-5 (Fig.14) Grasp the tool with the left hand, hold the tip of the wire with the right hand, and remove the wire from the Holding slot.

#### NOTICE

**The 2 wire tips of new Tiewire are twisted.**

1-6 (Fig.15) Straighten out the tip of the wire, and insert the twisted wire into the Wire guide (19) parallel.

1-7 (Fig.16) Confirm through the Window that the twisted part of wire has reached past two Feeding gears (18).

1-8 (Fig.17) Press the Release stopper (9) up, and confirm that the Release button has been raised up.

1-9 (Fig.18) Close the Magazine cover and rotate the Magazine stopper 45° clockwise.

### If the Window is dirty

Open the Window (Fig.1.17) and wipe off the dirt on the inside of the Window with a cloth. Close the Window again after cleaning to ensure that foreign objects will not be able to enter the tool.

### 2. How to operate RB441T

(Fig.6) Set the Main switch (15) at "OFF", the Trigger lock (2) at "LOCK" and remove the Battery pack (5).

2-1 (Fig.19) Mount the Battery pack on the tool's main body until a click is heard.

2-2 (Fig.20) When Main switch (15) is turned "ON", the Hook (Fig.1.16) of the tip rotates automatically for initializing, absolutely do not bring your fingers close to any rotating and moving part. Set the Main switch at "ON" and the trigger lock (2) at "UNLOCK".

2-3 (Fig.21) Tilt the tool 45° angle to the crossed rebars.

2-4 (Fig.22) Align the Center mark (11) to the center of the crossed rebars.

2-5 Once pull the Trigger, the tool automatically completes a series of tying actions (feeding, cutting, gripping and tying).



#### WARNING

- (Fig.23) When the Main switch (Fig.1.15) is turned "ON", the Hook (Fig.1.16) of the tip rotates automatically for initializing, absolutely do not bring your fingers close to any rotating and moving part.
- Do not touch any rotating and moving part such as hook of the tip or the Tiewire during the tying work (while the machine is operating).

### 3. How to remove the Tiewire

(Fig.6) Set the Main switch (15) at "OFF", the Trigger lock (2) at "LOCK" and remove the Battery pack (5).

3-1 (Fig.9) Press the Release button (8) of the tool and confirm that the Release button is caught in the Release stopper (9).

- 3-2 (Fig.11) Rotate the Magazine stopper (⑥) to open the Magazine cover.
- 3-3 (Fig.24) Remove the Tiewire from the Magazine.
- 3-4 (Fig.25) Remove the wire with the plastic piece from the Wire guide.

#### 4. When the Tiewire runs out

(Fig.26) The plastic piece comes off when it is used up normally, and can be discarded separately as plastic and metal wire. (About 20 cm remains after normal use)

(Fig.6) Set the Main switch (⑮) at "OFF", the Trigger lock (②) at "LOCK" and remove the Battery pack (⑤).

#### 5. Tension adjustment

(Fig.27.⑬) This dial allows you to adjust wire tension torque slightly. To increase the tension, turn it in the counterclockwise. To decrease the tension, turn it in the clockwise.

#### 6. Auto Power-off feature

**This tool has "Auto Power-off" feature, which saves the power consumption of the Battery when the tool is not operated.**

If the tool is not operated for 30 minutes, the tool is automatically turned off. When the power is turned off automatically, turn the Main switch OFF and ON again to operate the tool.

#### 7. For proper tightness

- 7-1 (Fig. 21) Tilt the tool 45° angle to the crossed rebars.
- 7-2 (Fig.22) Align the Center mark (⑪) to the center of the crossed rebars.
- 7-3 (Fig.28) Apply the tool perpendicularly to the surface of the crossed rebars.

#### During tool operation

Do not move the tool during tying operation until the tool stops tying automatically.

7-4 (Fig.29) Tie in alternate direction.

7-5 (Fig.30) Cross tying.

Bent the knot of the first tie before making the second tying.

#### 8. How to reload previously used Tiewire

(Fig.31) Without twisting the 2 wires, insert them into the Wire guide (⑲).

## 13.STORAGE

Do not store the tool in a cold weather environment. Keep the tool in a warm area. When not in use, the tool should be stored in a warm and dry place. Keep out of reach of children.

#### REMOVE REEL OF TIEWIRE

When you have finished the Tiewire, remove the reel from the tool.

#### STORE THE TOOL

When you have finished tying work or when the tool will not be used for a while, set the Main switch (Fig.1.⑮) at "OFF", the Trigger lock (Fig.1.②) at "LOCK" and remove the Battery pack (Fig.1.⑤). The tool and accessories should be stored in a well-ventilated dry place where the temperature will not exceed 40°C (104°F).

The Battery pack with the Pack cap (Fig.2.⑳) to prevent short circuits should be stored in a well-ventilated dry place where the temperature will not exceed 30°C (86°F).



# 14. WARNING BUZZERS AND PROCEDURES TO FOLLOW

This tool sounds warning buzzers for the conditions described below. If the buzzer sounds, follow procedures according to the conditions described below.



## WARNING

- If the conditions described below occur, set the Main switch (Fig.1.⑮) at "OFF", the Trigger lock (Fig.1.②) at "LOCK" and remove the Battery pack (Fig.1.⑤) before following procedures.
- Do not touch the tying or rotating parts at the tip when setting the Main switch at "ON" under any circumstances.

### <Buzzer types and procedures to follow>

Buzzer types	Possible cause	Procedures to follow
Once (Pi, pi, pi...)	Wire is jammed in the Hook (Fig.1.⑯)	Check whether the wire or anything else is caught in the Hook
	Motor is hot	Let the tool rest and cool down
Twice (Pipi, pipi, pipi...)	Low battery	Charge the Battery pack
	Battery pack is not fully inserted	Insert the Battery pack properly
Three times (Pipipi, pipipi, pipipi...)	Tiewire is used up	Replace with a new Tiewire
	Tiewire is jammed	Open the Magazine cover (Fig.12.⑳) and fix the jammed wire
Continuous high pitched beep (Piii...)	Curl guide (Fig.1.⑩) is open	Confirm supported rebar diameters
Single-short and continuous high & low pitched chime (Pipo / Pii poh Pii poh...)	Internal structure; defect in internal driving mechanism	Immediately discontinue operation and set the Main switch (Fig.6.⑮) at "OFF", the Trigger lock (Fig.6.②) at "LOCK" and remove the Battery pack (Fig.6.⑤) before consulting. Then contact the dealer where the tool was purchased or MAX CO., LTD. authorized distributors.

### <When no buzzer sounds but malfunction is suspected>

Symptom	Possible cause	Procedures to follow
Main switch is "ON" but does not work	Dead battery	Switch to a new battery and confirm whether it works
Product does not function	Auto Power-off feature operated	Try switching the Main switch (Fig.1.⑮) from OFF to ON
Tying is not proper	Wire is touching rebars while tying	Tie so that wire is not touching rebars
Twisted off	Rebar size is not applicable	Use with supported rebars diameters
	Tension adjustment dial is too tight	Adjust tension adjustment dial (Fig.1.⑬)
Tension is too loose	The tied section is not on the Center mark (Fig.22.⑪)	Align the Center mark to the center of the crossed rebars and pull the trigger
	Rebar size is not applicable	Use with supported rebar diameters
	Tension adjustment dial is too loose	Adjust tension adjustment dial tighter (Fig.1.⑬)
Tie form is notably deformed	Worn or broken parts	Immediately discontinue operation and set the Main switch (Fig.6.⑮) at "OFF", the Trigger lock (Fig.6.②) at "LOCK" and remove the Battery pack (Fig.6.⑤) before consulting. Then contact the dealer where the tool was purchased or MAX CO., LTD. authorized distributors.
Increased frequency of jamming		

# RB441T(CE)

EXPLODED  
VIEW AND SPARE PARTS LIST

SCHEMA ECLATE ET LISTE DES  
PIECES DE RECHANGE

DESPIECE DE LA MAQUINA Y LISTA  
DE RECAMBIOS

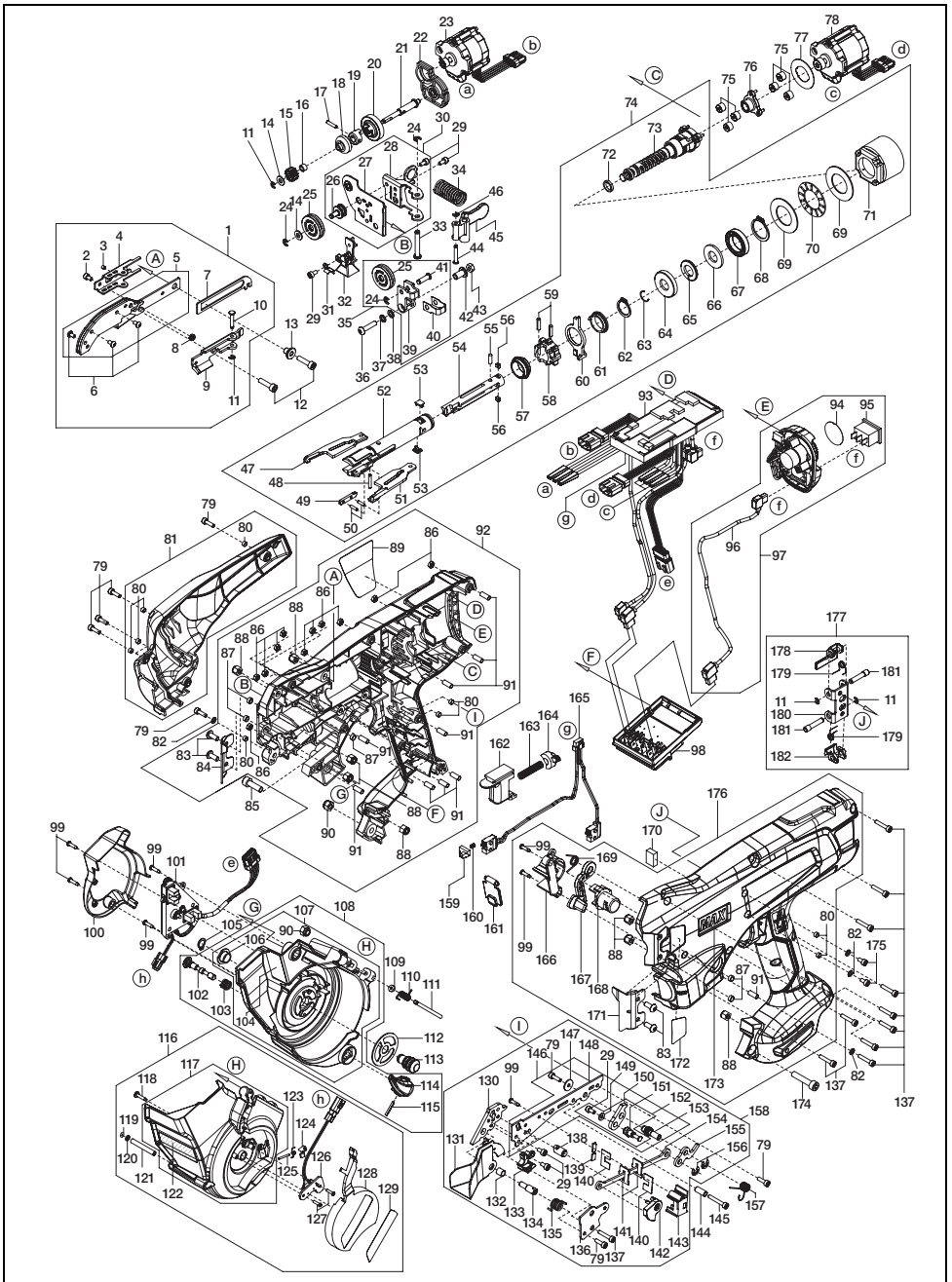

**RB441T(CE)**

ITEM NO.	PART NO.	MATERIAL	ENGLISH	FRANÇAIS	ESPAÑOL
1	RB70618	Steel	ARM A ASSY	ENSEMBLE DU BRAS	CONJUNTO DE BRAZO "A"
2	BB40481	Steel	BOLT 3X5	BOULON 3X5	PERNO 3X5
3	AA71408	Steel	SCREW M3X3	VIS M3X3	TORNILLO M3X3
4	RB12633	Steel	WIRE GUIDE BASE	BASE DU GUIDE FIL	BASE DE GUÍA DEL ALAMBRE
5	RB81278	Steel	ARM A UNIT	BRAS A	BRAZO "A"
6	BB41714	Steel	BOLT 3X5 SG	BOULON 3X5 SG	PERNO 3X5 SG
7	RB12636	Steel	WIRE GUIDE LEVER	LEVIER DU GUIDE FIL	PALANCA DE GUÍA DEL ALAMBRE
8	KK29117	Steel	COMPRESSION SPRING 9117	RESSORT À PRESSION 9117	MUELLE DE COMPRESIÓN 9117
9	RB70620	Steel	WIRE GUIDE UNIT	GUIDE FIL	GUÍA DEL ALAMBRE
10	FF41865	Steel	STEP PIN 1865	BOULON À GRADINS 1865	PERNO ESCALONADO 1865
11	JJ10113	Steel	E-RING 2.5	BAGUE 2,5	ANILLO EN "E" 2,5
12	BB40420	Steel	BOLT 4X13	BOULON 4X13	PERNO 4X13
13	FF52115	Steel	HOLLOW PIN 2115	GOUPILLE CREUSE 2115	PERNO HUECO 2115
14	EE39861	Steel	WASHER 4.3X9X1	RONDELLE 4,3X9X1	ARANDELA 4,3X9X1
15	RB10770	Steel	FEEDING GEAR A	ENGRENAGE D'ALIMENTATION	ENGRANAJE DE ALIMENTACIÓN "A"
16	FF51715	Steel	HOLLOW PIN 1715	GOUPILLE CREUSE 1715	PERNO HUECO 1715
17	FF31559	Steel	PARALELL PIN 1559	GOUPILLE PARALLÈLE 1559	PERNO PARALELO 1559
18	RB12740	Steel	SHAFT COLLAR	COLLIER D'AXE	COLLAR DE EJE
19	RB12653	Steel	CLUTCH B	EMBRAYAGE B	ACOPAMIENTO "B"
20	RB12651	Steel	CLUTCH A	EMBRAYAGE A	ACOPAMIENTO "A"
21	RB12652	Steel	FEEDING GEAR SHAFT A	AXE DE L'ENGRENAGE D'ALIMENTATION A	EJE DE ENGRANAJE DE ALIMENTACIÓN "A"
22	RB70700	PC, Steel	FEEDING MOTOR BASE UNIT	BASE DU MOTEUR D'ALIMENTATION	BASE DE MOTOR DE ALIMENTACIÓN
23	RB70627	Steel	FEEDING MOTOR	MOTEUR D'ALIMENTATION	MOTOR DE ALIMENTACIÓN
24	JJ10514	Steel	E-RING 3 CF	BAGUE 3 CF	ANILLO EN "E" 3 CF
25	RB70625	Steel	FEEDING GEAR B UNIT	ENGRENAGE D'ALIMENTATION B	ENGRANAJE DE ALIMENTACIÓN "B"
26	RB12655	Steel	FEEDING GEAR SHAFT B	AXE DE L'ENGRENAGE D'ALIMENTATION B	EJE DE ENGRANAJE DE ALIMENTACIÓN "B"
27	RB70698	Steel	FEEDING GEAR BASE UNIT	BASE DE L'ENGRENAGE D'ALIMENTATION	BASE DE ENGRANAJE DE ALIMENTACIÓN
28	RB12658	Steel	SPRING BASE	BASE DU RESSORT	BASE DE MUELLE
29	BB40824	Steel	BOLT 3X6	BOULON 3X6	PERNO 3x6
30	RB81283	Steel	FEEDING GEAR BASE ASSY	ENSEMBLE DE LA BASE DE L'ENGRENAGE D'ALIMENTATION	CONJUNTO DE BASE DE ENGRANAJE DE ALIMENTACIÓN
31	RB12659	Stainless Steel	LEAF SPRING	RESSORT PLAT	MUELLE LAMINADO
32	RB70667	Steel	WIRE GUIDE C UNIT	GUIDE FIL C	GUÍA DEL ALAMBRE "C"
33	FF41867	Steel	STEP PIN 1867	BOULON À GRADINS 1867	PERNO ESCALONADO 1867
34	KK29119	Steel	COMPRESSION SPRING 9119	RESSORT À PRESSION 9119	MUELLE DE COMPRESIÓN 9119
35	RB81293	Aluminum, Steel	RELEASE LEVER A ASSY	ENSEMBLE DU LEVIER DE DÉCLENCHEMENT A	CONJUNTO DE PALANCA DE DESBLOQUEO "A"
36	BB41712	Steel	BOLT 4X18 C	BOULON 4X18 C	PERNO 4X18 C
37	EE11103	Steel	SPRING WASHER 2-4	RONDELLE DE RESSORT 2-4	ARANDELA DE MUELLE 2-4
38	EE39825	Steel	WASHER 4.5X7.4X0.8	RONDELLE 4,5X7,4X0,8	ARANDELA 4,5X7,4X0,8
39	RB12682	Aluminum	RELEASE LEVER A	LEVIER DE DÉCLENCHEMENT A	PALANCA DE DESBLOQUEO "A"
40	RB12683	Steel	RELEASE LEVER A CAP	COUVERCLE DU LEVIER DE DÉCLENCHEMENT A	TAPA DE PALANCA DE DESBLOQUEO "A"
41	FF41869	Steel	STEP PIN 1869	BOULON À GRADINS 1869	PERNO ESCALONADO 1869
42	FF52117	Steel	HOLLOW PIN 2117	GOUPILLE CREUSE 2117	PERNO HUECO 2117
43	CC42512	Steel	HEX NUT 1A M4 CF	ÉCROU HEXAGONAL 1A M4 CF	TUERCA HEXAGONAL 1A M4 CF
44	FF41868	Steel	STEP PIN 1868	BOULON À GRADINS 1868	PERNO ESCALONADO 1868
45	RB12657	Aluminum	RELEASE LEVER B	LEVIER DE DÉCLENCHEMENT B	PALANCA DE DESBLOQUEO "B"
46	JJ10510	Steel	E-RING 2.3 CF	BAGUE 2,3 CF	ANILLO EN "E" 2,3 CF
47	RB12609	Steel	HOOK L	CROCHET L	GANCHO IZQUIERDO
48	RB12613	Steel	CARBIDE PIN 2.5X14.8	GOUPILLE EN CARBURE 2,5X14,8	PERNO DE CARBURO 2,5X14,8
49	RB12616	Steel	SLEEVE COVER	MANCHON DE PROTECTION	CUBIERTA DE MANGUITO
50	FF21267	Steel	SPRING PIN 2X8	GOUPILLE ÉLASTIQUE 2X8	PERNO DE MUELLE 2X8
51	RB12610	Steel	HOOK R	CROCHET R	GANCHO DERECHO
52	RB12614	Steel	SLEEVE A	MANCHON A	MANGUITO "A"
53	RB12712	Steel	KEY	CLAVETTE	CHAVETA
54	RB12611	Steel	CENTER HOOK	CROCHET CENTRAL	GANCHO CENTRAL
55	FF31718	Steel	PARALELL PIN 1718	GOUPILLE PARALLÈLE 1718	PERNO PARALELO 1718
56	RB12713	Steel	KEY B	CLAVETTE B	CHAVETA "B"
57	RB12612	Steel	SLEEVE GUIDE	GUIDE DE MANCHON	GUÍA DE MANGUITO
58	RB12615	Steel	SLEEVE B	MANCHON B	MANGUITO "B"

**RB441T(CE)**

ITEM NO.	PART NO.	MATERIAL	ENGLISH	FRANÇAIS	ESPAÑOL
59	FF21234	Steel	SPRING PIN 3X12	GOUPILLE ÉLASTIQUE 3X12	PERNO DE MUELLE 3X12
60	RB12617	Steel	CUTTER RING	BAGUE DE COUPEAU	ANILLO DE CORTADORA
61	RB12618	Steel	CUTTER RING GUIDE	GUIDE DE BAGUE DE COUPEAU	GUÍA DE ANILLO DE CORTADORA
62	JJ21606	Steel	C-RING 15	BAGUE EN C 15	ANILLO EN "C" 15
63	JJ80901	Steel	C-RING 11	BAGUE EN C 11	ANILLO EN "C" 11
64	RB12714	Steel	BUMPER GUIDE	GUIDE DE L'AMORTISSEUR	GUÍA DE AMORTIGUADOR
65	RB12619	Urethane rubber	BUMPER	AMORTISSEUR	AMORTIGUADOR
66	EE39859	Steel	WASHER 11.1X23.4X2	RONDELLE 11,1X23,4X2	ARANDELA 11,1X23,4X2
67	LL11756	Steel	BEARING 6803ZZ	ROULEMENT 6803ZZ	COJINETE 6803ZZ
68	JJ21603	Steel	C-RING 20	BAGUE EN C 20	ANILLO EN "C" 20
69	EE39865	Steel	WASHER 20X35X1	RONDELLE 20X35X1	ARANDELA 20X35X1
70	LL41003	Steel	THRUST BEARING AXK1104	PALIER DE BUTÉE AXK1104	COJINETE DE EMPUJE AXK1104
71	RB12620	PA	INTERNAL GEAR	ENGRENAGES INTERNE	ENGRANAJE INTERNO
72	RB12720	Silicone rubber	D RING	BAGUE EN D	ANILLO EN "D"
73	RB70699	Steel	TIP AXIS A UNIT	AXE D'EXTREMITÉ A	EJE DE EXTREMIDAD "A"
74	RB70613	Steel, PA, etc	TWIST ASSY	ENSEMBLE DE TORSADE	CONJUNTO DE TORSIÓN
75	RB12622	Steel	PLANETARY GEAR	ENGRENAGE PLANÉTAIRE	ENGRANAJES PLANETARIOS
76	RB70642	Steel	SUN GEAR UNIT	UNITE DE PIGNON SOLEIL	ENGRANAJE CENTRAL
77	RB12623	Stainless Steel	WASHER, TWIST AXIS	RONDELLE, AXE DE TORSADE	ARANDELA, EJE DE TORSIÓN
78	RB70617		TWISTING MOTOR	MOTEUR DE TORSION	MOTOR DE TORSIÓN
79	BB40425	Steel	BOLT 3X10	BOULON 3X10	PERNO 3X10
80	FF51817	Steel	HOLLOW PIN 1817	GOUPILLE CREUSE 1817	PERNO HUECO 1817
81	RB70684	PA, Steel	MOTOR COVER UNIT	CAPOT DU MOTEUR	CUBIERTA DE MOTOR
82	EE32104	Stainless Steel	WASHER 2-3	RONDELLE 2-3	ARANDELA 2-3
83	BB41706	Steel	BOLT 4X10 CF	BOULON 4X10 CF	PERNO 4X10 CF
84	RB12634	Steel	COVER L(441T)	CAPOT L (441T)	CUBIERTA IZQUIERDA (441T)
85	BB40310	Steel	BOLT 5X16	BOULON 5X16	PERNO 5X16
86	CC41104	Steel	HEX NUT 1-3	ÉCROU HEXAGONAL 1-3	TUERCA HEXAGONAL 1-3
87	FF51710	Steel	HOLLOW PIN 1710	GOUPILLE CREUSE 1710	PERNO HUECO 1710
88	CC49308	Steel	HEX NUT M4	ÉCROU HEXAGONAL M4	TUERCA HEXAGONAL M4
89	RB12690	PET	SPECIFICATION LABEL	ÉTIQUETTE DES SPÉCIFICATIONS	ETIQUETA DE ESPECIFICACIONES
90	CC49411	Steel	HEX NUT M5	ÉCROU HEXAGONAL M5	TUERCA HEXAGONAL M5
91	FF51714	Steel	HOLLOW PIN 1714	GOUPILLE CREUSE 1714	PERNO HUECO 1714
92	RB70685	PA, Steel, copper, etc	FRAME L ASSY(441T)	ENSEMBLE DU CADRE L (441T)	CONJUNTO DE ARMAZÓN IZQUIERDO (441T)
93	RB81280		MAIN CIRCUIT BOARD UNIT	PLAQUETTE DE CIRCUIT PRINCIPALE	PLACA DE CIRCUITO PRINCIPAL
94	RB12687	PET	LABEL, TORQUE DIAL	PLAQUE, CADRAN À COUPLE	ETIQUETA, DISCO SELECTOR DE PAR
95	RB70457		MAIN SWITCH UNIT(397)	INTERRUPTEUR GÉNÉRAL (397)	INTERRUPTOR PRINCIPAL (397)
96	RB70626		POWER CORD ORANGE UNIT	CORDON D'ALIMENTATION ORANGE	UNIDAD DE CÓDIGO DE POTENCIA NARANJA
97	RB70637	PC, POM, Aluminum, etc	SWITCH BASE ASSY	BASE DE COMMUTEUR	CONJUNTO DE BASE DE INTERRUPTOR
98	RB70697	PBT, copper	ELECTRODE UNIT	ÉLECTRODE	ELECTRODO
99	AA05952	Steel	SCREW 2.6X10	VIS 2.6X10	TORNILLO 2.6X10
100	RB12674	PA	MAGAZINE CAP	COUVERCLE DU MAGASIN	TAPA DE COMPARTIMENTO DE BOBINA
101	RB70640		SENSOR CURCUIT BOARD F UNIT	PLAQUETTE DE CIRCUIT DE SENSEUR F	PLACA DE CIRCUITO DE SENSOR "F"
102	RB12673	Steel	MAGAZINE STOPPER SHAFT	AXE DE LA BUTÉE DU MAGASIN	EJE DE BLOQUEADOR DE COMPARTIMENTO DE BOBINA
103	KK24186	Stainless Steel	COMPRESSION SPRING 4186	RESSORT À PRESSION 4186	MUELLE DE COMPRESIÓN 4186
104	RB12684	PET	WIRE OPERATION LABEL	ÉTIQUETTE D'UTILISATION DU FIL	ETIQUETA DE OPERACIÓN DE CABLE
105	JJ21601	Steel	C-RING 8	BAGUE EN C 8	ANILLO EN "C" 8
106	FF52116	Steel	HOLLOW PIN 2116	GOUPILLE CREUSE 2116	PERNO HUECO 2116
107	RB81286	PA, Steel, PET	MAGAZINE UNIT	MAGASIN	COMPARTIMENTO DE BOBINA
108	RB81294	PA, Steel, POM, etc	MAGAZINE SUB ASSY	SOUS-ENSEMBLE DU MAGASIN	SUBCONJUNTO DE COMPARTIMENTO DE BOBINA
109	EE39609	Urethane rubber	PLAIN RUBBER WASHER 1.8X6X2	RONDELLE PLATE DE CAOUTCHOUC 1,8X6X2	ARANDELA DE CAUCHO 1,8X6X2
110	KK34098	Stainless Steel	TORSION SPRING 4098	RESSORT DE TORSION 4098	MUELLE DE TORSIÓN 4098
111	FF43419	Steel	STEP PIN 3419	BOULON À GRADINS 3419	PERNO ESCALONADO 3419
112	RB12715	Steel	MAGAZINE PLATE	PLAQUE DU MAGASIN	PLACA DE COMPARTIMENTO DE BOBINA
113	RB12671	Steel	ROTARY SHAFT	AXE ROTATIF	EJE GIRATORIO
114	RB12672	POM	MAGAZINE STOPPER	BUTÉE DU MAGASIN	BLOQUEADOR DE COMPARTIMENTO DE BOBINA
115	FF21629	Steel	SPRING PIN 2X14	GOUPILLE ÉLASTIQUE 2X14	PERNO DE MUELLE 2X14

**RB441T(CE)**

ITEM NO.	PART NO.	MATERIAL	ENGLISH	FRAÇAIS	ESPAÑOL
116	RB81289	PA, Steel, etc	MAGAZINE COVER ASSY	ENSEMBLE DE COUVERCLE DU MAGASIN	CONJUNTO DE CUBIERTA DE COMPARTIMENTO DE BOBINA
117	RB81284	PA, Steel	MAGAZINE COVER UNIT	COUVERCLE DU MAGASIN	CUBIERTA DE COMPARTIMENTO DE BOBINA
118	AA05560	Steel	SCREW 3X12 CF	VIS 3X12 CF	TORNILLO 3X12 CF
119	HH14169	Nitrile rubber	O-RING AS 568-003 1A	BAGUE EN O AS 568-003 1A	JUNTA TÓRICA AS 568-003 1A
120	EE39860	Steel	WASHER 5X2.6X1	RONDELLE 5X2. 6X1	ARANDELA 5X2.6X1
121	FF51713	Steel	HOLLOW PIN 1713	GOUPILLE CREUSE 1713	PERNO HUECO 1713
122	RB12706	PET	NOTICE LABEL	ÉTIQUETTE D'AVIS	ETIQUETA DE ADVERTENCIA
123	KK34097	Stainless Steel	TORSION SPRING 4097	RESSORT DE TORSION 4097	MUELLE DE TORSIÓN 4097
124	RB12669	Steel	REEL PRESS	PRESSE DE BOBINE	PRENSA DE BOBINA
125	FF31639	Steel	PARALELL PIN 1639	GOUPILLE PARALLÈLE 1639	PERNO PARALELO 1639
126	RB70641		SENSOR CURCUIT BOARD G UNIT	PLAQUETTE DE CIRCUIT DE SENSEUR G	PLACA DE CIRCUITO DE SENSOR "G"
127	AA31724	Steel	SCREW 2X8	VIS 2X8	TORNILLO 2X8
128	RB12667	PA	MAGAZINE COVER CAP	CAPUCHON DU COUVERCLE DU MAGASIN	TAPA DE CUBIERTA DE COMPARTIMENTO DE BOBINA
129	RB12688	PET	441T LABEL	ÉTIQUETTE 441T	ETIQUETA DE 441T
130	RB12639	Steel	CURL GUIDE B	GUIDE DE BOUCLAGE B	GUÍA DE CURVADO "B"
131	RB70624	Steel	CURL GUIDE A UNIT	GUIDE DE BOUCLAGE A	GUÍA DE CURVADO "A"
132	FF51712	Steel	HOLLOW PIN 1712	GOUPILLE CREUSE 1712	PERNO HUECO 1712
133	RB70666	Steel	WIRE GUDE B UNIT	GUIDE FIL B	GUÍA DEL ALAMBRE "B"
134	RB12641	Steel	CURL GUIDE SHAFT	AXE DU GUIDE DE BOUCLAGE	EJE DE GUÍA DE CURVADO
135	KK34096	Stainless Steel	TORSION SPRING 4096	RESSORT DE TORSION 4096	MUELLE DE TORSIÓN 4096
136	RB12644	Steel	ARM C	BRAS C	BRAZO "C"
137	BB40810	Steel	BOLT 3X16	BOULON 3X16	PERNO 3X16
138	RB12642	Steel	FIXED CUTTER	COUPEAU FIXE	CORTADORA FIJA
139	RB12723	Stainless Steel	CON-ROD GUIDE B	GUIDE DE LA TIGE DE CONNEXION B	GUÍA DE BIELA "B"
140	RB12721	Stainless Steel	CON-ROD COVER	CAPOT DE LA TIGE DE CONNEXION	CUBIERTA DE BIELA
141	RB12722	Stainless Steel	CON-ROD GUIDE A	GUIDE DE LA TIGE DE CONNEXION A	GUÍA DE BIELA "A"
142	RB12643	Steel	CUTTER	COUPEAU	CORTADORA
143	RB12724	POM	CON-ROD BASE	BASE DE LA TIGE DE CONNEXION	BASE DE BIELA
144	FF51711	Steel	HOLLOW PIN 1711	GOUPILLE CREUSE 1711	PERNO HUECO 1711
145	BB40717	Steel	BOLT 3X20 CF	BOULON 3X20 CF	PERNO 3X20 CF
146	RB70682	Steel	ARM B UNIT	BRAS B	BRAZO "B"
147	EE39857	Steel	WASHER 3.2X11X1	RONDELLE 3,2X11X1	ARANDELA 3,2X11X1
148	RB12637	Steel	ARM B	BRAS B	BRAZO "B"
149	EE39858	Steel	WASHER 3.2X7X1	RONDELLE 3.2X7X1	ARANDELA 3.2X7X1
150	RB12645	Steel	CUTTER LEVER A	LEVIER DE COUPEAU A	PALANCA DE CORTADORA "A"
151	RB12648	Steel	CUTTER PIN	GOUPILLE DU COUPEAU	PERNO DE CORTADORA
152	RB70683	Steel	CUTTER LEVER A UNIT	AXE DU COUPEAU A	PALANCA DE CORTADORA "A"
153	RB12647	Steel	CUTTER SHAFT	AXE DU COUPEAU	EJE DE CORTADORA
154	RB12649	Steel	CON-ROD	TIGE DE CONNEXION	BIELA
155	RB12646	Steel	CUTTER LEVER B	LEVIER DE COUPEAU B	PALANCA DE CORTADORA "B"
156	JJ10509	Steel	E-RING 4 CF	BAGUE 4 CF	ANILLO EN "E" 4 CF
157	KK33398	Steel	TORSION SPRING 3398	RESSORT DE TORSION 3398	MUELLE DE TORSIÓN 3398
158	RB70621	Steel, POM, etc	ARM B ASSY	ENSEMBLE DU BRAS B	CONJUNTO DE BRAZO "B"
159	RB12663	POM	SWITCH BLOCK	BLOC INTERRUPTEUR	BLOQUE DE INTERRUPTOR
160	KK24191	Stainless Steel	COMPRESSION SPRING 4191	RESSORT À PRESSION 4191	MUELLE DE COMPRESIÓN 4191
161	RB12815	PC	WINDOW	FENÊRE	VENTANILLA
162	RB12080	POM	TRIGGER	DÉCLENCHEUR	DISPARADOR
163	KK23656	Steel	COMPRESSION SPRING 3656	RESSORT À PRESSION 3656	MUELLE DE COMPRESIÓN 3656
164	RB12101	PC	TRIGGER LOCK LEVER	LEVIER DE BLOCAGE DE LA COMMANDE	PALANCA DE SEGURO DE DISPARADOR
165	RB70623	Steel	SWITCH HARNESS UNIT	CÂBLAGE DE L'INTERRUPTEUR	CABLEADO DE INTERRUPTOR
166	RB12665	PA	RELEASE BUTTON BASE	BASE DU BOUTON DE DÉSENGAGEMENT	BASE DE BOTÓN DE DESBLOQUEO
167	RB12664	POM	RELEASE STOPPER	PIÈCE DE RETENUE DE DÉCLENCHEMENT	BLOQUEO
168	RB12662	POM	RELEASE BUTTON	BOUTON DE DÉSENGAGEMENT	BOTÓN DE DESBLOQUEO
169	KK33401	Steel	TORSION SPRING 3401	RESSORT DE TORSION 3401	MUELLE DE TORSIÓN 3401
170	RB12725	Urethane	SPONGE	ÉPONGE	ESPONJA
171	RB12635	Steel	COVER R(441T)	CAPOT R (441T)	CUBIERTA DERECHA (441T)
172	RB12689	PET	WARNING LABEL	ÉTIQUETTE D'AVERTISSEMENT	ETIQUETA DE ADVERTENCIA
173	RB12661	ABS	BRAND PLATE	PLAQUE DE MARQUE	PLACA DE MARCA
174	BB40708	Steel	BOLT 5X25	BOULON 5X25	PERNO 5X25

**RB441T(CE)**

<b>ITEM NO.</b>	<b>PART NO.</b>	<b>MATERIAL</b>	<b>ENGLISH</b>	<b>FRANÇAIS</b>	<b>ESPAÑOL</b>
175	BB40716	Steel	BOLT 3X6 CF	BOULON 3X6 CF	PERNO 3X6 CF
176	RB70629	PA, Steel, POM, etc	FRAME R ASSY(441T)	ENSEMBLE DU CADRE R (441T)	CONJUNTO DE ARMAZÓN DERECHO (441T)
177	RB70616	Steel	JAW BASE ASSY	BASE DE MACHOIRE ASSY	CONJUNTO DE BASE DE MORDAZA
178	RB12627	Steel	JAW B	MÂCHOIRE B	MORDAZA "B"
179	KK33249	Steel	TORSION SPRING 3249	RESSORT DE TORSION 3249	MUELLE DE TORSIÓN 3249
180	RB12625	Steel	JAW BASE	BASE DE MACHOIRE	BASE DE MORDAZA
181	FF41864	Steel	STEP PIN 1864	BOULON À GRADINS 1864	PERNO ESCALONADO 1864
182	RB12626	Steel	JAW A	MÂCHOIRE A	MORDAZA "A"
999	RB81184	Steel	BELT HOOK ASSY	ENSEMBLE DU CROCHET DE COURROIE	CONJUNTO DE GANCHO PARA CINTURÓN

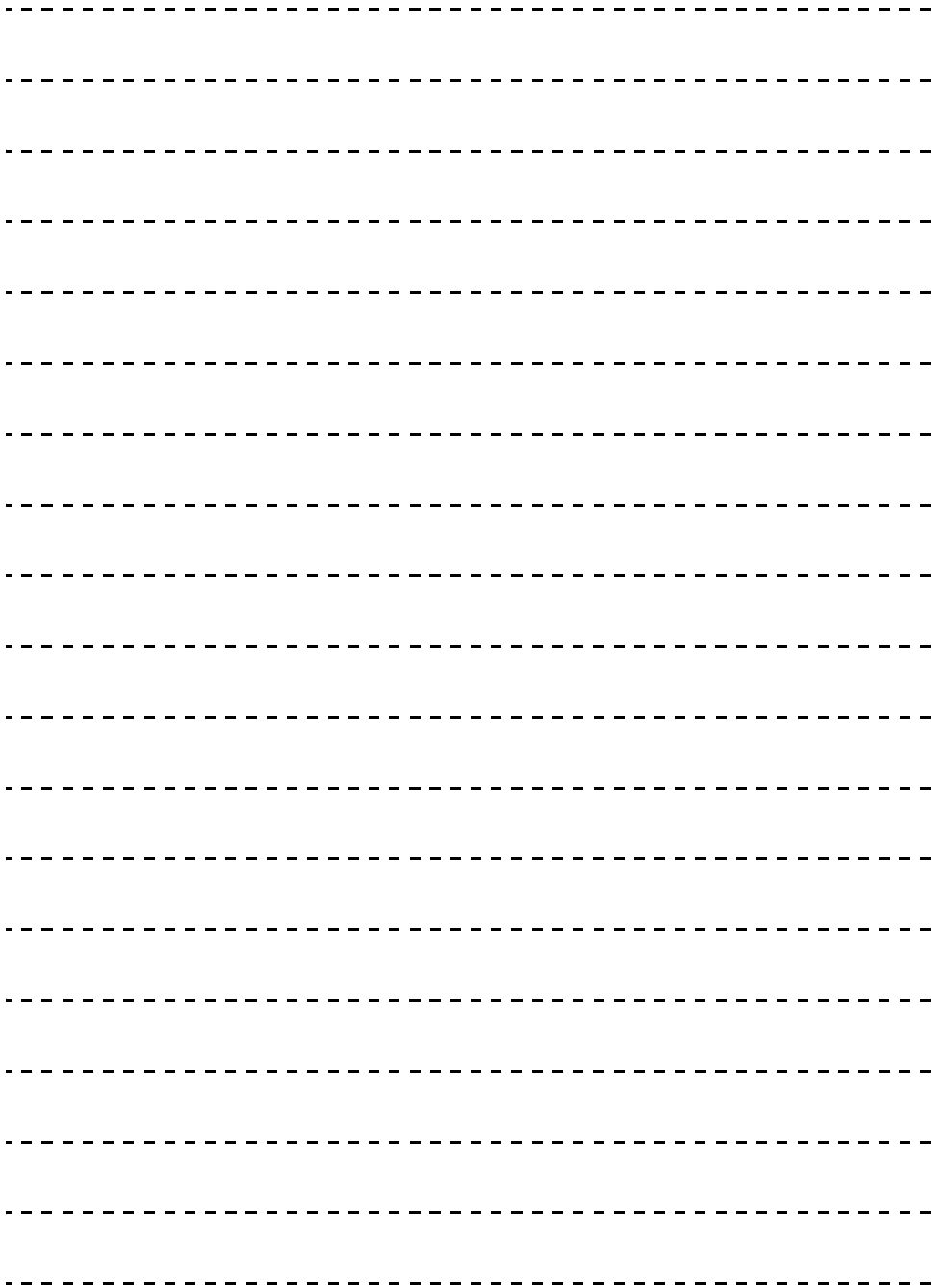

# RB441T(CE)

## EU DECLARATION OF CONFORMITY

We hereby declare that the following our product conforms to protection of health and safety of persons, and protection of the environment.

Product/Apparatus Model	Cordless Re-Bar Tying Tool RB441T
Manufacturer	MAX CO., LTD. 1848 Kawai, Tamamura-machi, Sawa-gun, Gunma, 370-1117, Japan
Authorized Complier in the community	MAX EUROPE B.V. Camerstraat 19 1322 BB Almere The Netherlands

This declaration of conformity is issued under the sole responsibility of the above manufacturer.

The object of declaration described above is in conformity with the EU harmonisation legislation below.

Machinery Directive	2006/42/EC EN60745-1:2009+A11:2010
EMC Directive	2014/30/EU EN61000-6-4:2007+A1:2011/EN61000-6-2:2005
RoHS Directive	2011/65/EU

Noise Emission in the Environment by Equipment for Use Outdoors Directive 2000/14/EC

Title	Senior Manager Environment & Quality Assurance Department
-------	--

Being the responsible person appointed by the manufacturer and employed by MAX CO., LTD.

## DÉCLARATION DE CONFORMITÉ UE

Par la présente nous déclarons que les produits qui suivent sont conformes à la protection de la santé et de la sécurité des personnes, et à la protection de l'environnement.

Produit(Appareil) Modèle	Outil de ligature de barres RB441T
Fabricant	MAX CO., LTD. 1848 Kawai, Tamamura-machi, Sawa-gun, Gunma, 370-1117, Japan
Compilateur autorise' dans la Communauté	MAXEUROPE BV Camerstraat 19, 1322 BB Almere, Pays-Bas

Cette déclaration de conformité est émise sous la seule responsabilité du fabricant mentionné ci-dessus.

L'objet de la déclaration décrit au-dessus est en conformité avec la loi d'harmonisation UE mentionnée ci-dessous.

Directive Machines	2006/42/EC EN60745-1:2009+A11:2010
Directive CEM	2014/30/EU EN61000-6-4:2007+A1:2011/EN61000-6-2:2005
Directive RoHS	2011/65/UE

Emission de bruit dans l'environnement des Matériels Utilisés à l'extérieur Directive 2000/14/CE

Titre	Directeur Principal Service Environnement & Assurance Qualité
-------	--

En tant que personne responsable désignée par le fabricant et employée par MAX CO., LTD.

## DECLARACIÓN DE CONFORMIDAD UE

Por la presente declaramos que los siguientes productos se encuentran en conformidad con las normativas de protección de salud y seguridad de las personas y de protección del medio ambiente.

Producto(Aparato) Modelo	Atadora de armaduras de refuerzo RB441T
Fabricante	MAX CO., LTD. 1848 Kawai, Tamamura-machi, Sawa-gun, Gunma, 370-1117, Japan
Compilador autorizado en la Comunidad	MAXEUROPE BV Camerstraat 19, 1322 BB Almere, Pays-Bas

Esta declaración de conformidad se ha publicado bajo la responsabilidad exclusiva del fabricante anteriormente mencionado.

La finalidad de la declaración anteriormente descrita se encuentra en conformidad con la siguiente legislación de armonización de la UE.

Directiva de Maquinaria	2006/42/EC EN60745-1:2009+A11:2010
Directiva CEM	2014/30/EU EN61000-6-4:2007+A1:2011/EN61000-6-2:2005
Directiva RoHS	2011/65/UE

Emission de Ruido en el Medio Ambiente por Equipo para uso al Aire libre Directiva 2000/14/CE

Cargo	Gerente General Departamento de Garantía de Calidad y Medio Ambiente
-------	---

Siendo la persona responsable nombrada por el fabricante y empleada por MAX CO., LTD.

## EU-KONFORMITÄTSERKLÄRUNG

Hiermit erklären wir, dass unser folgendes Produkt den Gesundheits- und Sicherheitsvorschriften von Personen und dem Umweltschutz entspricht.

Produkt(Gerät) Modell	Bewehrungsstahl-Bindewerkzeug RB441T
Hersteller	MAX CO., LTD. 1848 Kawai, Tamamura-machi, Sawa-gun, Gunma, 370-1117, Japan
Autorisierter Entsorger / Präsident in der Gemeinschaft	MAX.EUROPE BV Camerstraat 19, 1322 BB Almere, Holland

Die alleinige Verantwortung für die Ausstellung dieser Konformitätserklärung trägt der obige Hersteller.

Das oben beschriebene Produkt steht im Einklang mit den nachfolgenden EU-Harmonisierungsvorschriften.

Maschinen Richtlinie	2006/42/EC EN60745-1:2009+A11:2010
EMV-Richtlinie	2014/30/EU EN61000-6-4:2007+A1:2011/EN61000-6-2:2005
RoHS Richtlinie	2011/65/EU

Geräuschemission in Umweltrfragen von zur Verwendung im Freien Richtlinie 2000/14/EG

Titel	Senior Manager Abteilung Umweltschutz & Qualitätssicherung
-------	---

Bei MAX CO., LTD. angestellt und vom Hersteller als verantwortliche Person bestellt.

## DICHIARAZIONE DI CONFORMITÀ UE

Con la presente, dichiariamo che il seguente nostro prodotto è conforme alle direttive sulla protezione della salute e sicurezza delle persone e alle direttive sulla tutela dell'ambiente.

Prodotto(Apparecchio) Modello	Utensile per la legatura dei ferri d'armatura RB441T
Produttore	MAX CO., LTD. 1848 Kawai, Tamamura-machi, Sawa-gun, Gunma, 370-1117, Japan
Compilatore autorizzato nella Comunità	MAX.EUROPE BV Camerstraat 19,1322 BB Almere, Holanda

Questa dichiarazione di conformità viene emessa sotto la responsabilità esclusiva del produttore indicato in precedenza.

L'oggetto della dichiarazione sopra descritta è in conformità con le misure di armonizzazione UE indicate di seguito.

Direttiva Macchine	2006/42/EC EN60745-1:2009+A11:2010
Direttiva EMC	2014/30/EU EN61000-6-4:2007+A1:2011/EN61000-6-2:2005
Direttiva RoHS	2011/65/UE

Emissioni di rumore ambientale di materiale utilizzato all'esterno Direttiva 2000/14/CE

Titolo	Senior Manager Dipartimento Ambiente e Controllo Qualità
--------	---

In qualità di responsabile incaricato dal produttore e dipendente di MAX CO., LTD.



- The content of this manual might be changed without notice for improvement.
- Le contenu du présent manuel est sujet à modification sans préavis, en vue d'y apporter des améliorations.
- El contenido de este manual puede sufrir modificaciones sin previo aviso para la introducción de mejoras.



**MAX EUROPE B.V.**

Camerastraat 19  
1322 BB Almere The Netherlands  
Phone: +31-36-546-9669  
FAX: +31-36-536-3985  
sales@max-europe.com  
www.max-europe.com



4100252  
171025-00/01

