

www.wackergroup.com

0162089en	008
1107	

Mobile Generator

G 50

G 70

G 85



OPERATOR'S MANUAL



0 1 6 2 0 8 9 E N

1.	Foreword	5
2.	Safety Information	6
2.1	Operating Safety	8
2.2	Service Safety	10
2.3	Operator Safety while using Internal Combustion Engines	11
2.4	Towing Safety	12
2.5	Reporting Trailer Safety Defects	13
2.6	Label Location	14
2.7	Safety and Operating Labels	16
3.	Operation	24
3.1	Control Panels	24
3.2	Generator Monitoring	26
3.3	Engine Monitoring	27
3.4	Engine Shutdown Faults	28
3.5	Current Overload Fault	29
3.6	Application	29
3.7	Voltage Selector Switch	30
3.8	Emergency Stop Switch	31
3.9	Main Line Circuit Breaker	32
3.10	Engine Start Switch	33
3.11	Voltage Adjustment Rheostat	33
3.12	Warning Light	33
3.13	Connection Lugs	34
3.14	Ground Connection	35
3.15	Convenience Receptacles	35
3.16	Remote Run Terminal Block	35
3.17	Panel Door Interlock Switch	35
3.18	Terminal Connections	36
3.19	Before Starting	37
3.20	Manual Start-up	38
3.21	Running the Generator	40
3.22	Engine Power Correction Factors	40
3.23	Shutting Down Generator	42
3.24	Cold Weather Start-up	42
3.25	Lifting	42
3.26	Overnight Storage	42
3.27	Long-term Storage	42

3.28	Automatic/Remote Start-up	43
3.29	Remote/Transfer Switch	44
3.30	Towing	45
4.	Maintenance	47
4.1	Periodic Maintenance Schedule	47
4.2	New Machines	48
4.3	Resetting the Periodic Maintenance Timer	48
4.4	Air Cleaner	49
4.5	Engine Lubrication	50
4.6	Engine Coolant	51
4.7	Trailer Maintenance	51
4.8	Troubleshooting Automatic Shutdown	52
4.9	Wire Colors	53
4.10	Generator and Receptacle Wiring	54
4.11	Trailer Wiring	60
4.12	G 50/G 70 Engine Wiring	62
4.13	G 85 & G 70 w/ECU Engine Wiring	70
5.	Factory-Installed Options	74
5.1	Block Heater	74
5.2	Fuel/Water Separator	75
5.3	Electronic Governor	76
5.4	LCD Strip Heater	77
5.5	Low Coolant Shutdown	78
5.6	Lube Level Maintainer	79
5.7	Temperature-Activated Shutters	80
5.8	Lockable Battery Disconnect	80
5.9	Wiring Diagram	82
5.10	Wiring Diagram Components	83
5.11	Cam-Lock	84
5.12	Containment System	85
6.	Technical Data	86
6.1	Engine Data	86
6.2	Generator Data	88
6.3	Trailer and Skid Data	89
6.4	Dimensions	90

1 Foreword

This manual provides information and procedures to safely operate and maintain this Wacker model. For your own safety and protection from injury, carefully read, understand and observe the safety instructions described in this manual.

Keep this manual or a copy of it with the machine. If you lose this manual or need an additional copy, please contact Wacker Corporation. This machine is built with user safety in mind; however, it can present hazards if improperly operated and serviced. Follow operating instructions carefully! If you have questions about operating or servicing this equipment, please contact Wacker Corporation.

The information contained in this manual was based on machines in production at the time of publication. Wacker Corporation reserves the right to change any portion of this information without notice.

All rights, especially copying and distribution rights, are reserved.

Copyright 2007 by Wacker Corporation.

No part of this publication may be reproduced in any form or by any means, electronic or mechanical, including photocopying, without express written permission from Wacker Corporation.

Any type of reproduction or distribution not authorized by Wacker Corporation represents an infringement of valid copyrights and will be prosecuted. We expressly reserve the right to make technical modifications, even without due notice, which aim at improving our machines or their safety standards.

2. Safety Information

This manual contains DANGER, WARNING, CAUTION, *NOTICE* and NOTE callouts which must be followed to reduce the possibility of personal injury, damage to the equipment, or improper service.



This is the safety alert symbol. It is used to alert you to potential personal injury hazards. Obey all safety messages that follow this symbol to avoid possible injury or death.



DANGER

DANGER indicates a hazardous situation which, if not avoided, will result in death or serious injury.



WARNING

WARNING indicates a hazardous situation which, if not avoided, could result in death or serious injury.



CAUTION

CAUTION indicates a hazardous situation which, if not avoided, could result in minor or moderate injury.

NOTICE: Used without the safety alert symbol, **NOTICE** indicates a hazardous situation which, if not avoided, could result in property damage.

Note: *Contains additional information important to a procedure.*



DANGER

Danger of Electrocutation!

Danger of electrocution or severe electrical shock is present throughout the generator any time the engine is running! Read all safety notes contained in this section before operating or servicing this equipment.

No one except a trained electrician, familiar with this equipment, should attempt repairs to the generator! Test procedures which require that the generator be running must be performed using extreme caution.

This machine is built with user safety in mind; however, like any electrical device it can present serious hazards if improperly operated and serviced. Follow instructions carefully! Should questions arise during operation or service of this equipment, contact Wacker Corporation.

2.1 Operating Safety



WARNING

Familiarity and proper training are required for the safe operation of the machine. Machines operated improperly or by untrained personnel can be dangerous. Read the operating instructions contained in both this manual and the Engine Manual and familiarize yourself with the location and proper use of all controls. Inexperienced operators should receive instruction from someone familiar with the machine before being allowed to operate it.

- 2.1.1 NEVER operate the generator when open containers of fuel, paint, or other flammable liquids are near.
- 2.1.2 NEVER place flammable material or liquids near the generator.
- 2.1.3 NEVER operate the generator, or tools attached to the generator, with wet hands.
- 2.1.4 NEVER use worn electrical cords. Severe electrical shock and equipment damage may result.
- 2.1.5 NEVER operate the machine indoors unless exhaust fumes can be adequately ventilated.
- 2.1.6 NEVER overload the generator. The total amperage of the tools and equipment attached to the generator must not exceed the load rating of the generator.
- 2.1.7 NEVER allow untrained personnel to operate or service the generator. The generator set should be set up by a certified electrician.
- 2.1.8 NEVER operate generator in standing water.
- 2.1.9 NEVER touch the hot engine, exhaust, or generator components. Burns will result.
- 2.1.10 NEVER start a unit in need of repair.
- 2.1.11 Use the emergency stop button only in an actual emergency. DO NOT restart the engine until the cause of the trouble has been determined and fixed.
- 2.1.12 ALWAYS wear hearing protection when operating equipment.
- 2.1.13 ALWAYS follow starting and stopping instructions described in this manual. Know how to operate and stop generator before starting it.
- 2.1.14 ALWAYS make a walk-around inspection of the generator set before starting it. Open side doors and visually inspect engine compartment for obvious damage or the presence of foreign objects which might affect operation.
- 2.1.15 ALWAYS keep the machine at least one meter (three feet) away from structures, buildings, and other equipment during use.
- 2.1.16 ALWAYS store the machine properly when it is not being used. The machine should be stored in a clean, dry location out of the reach of children.

- 2.1.17 ALWAYS keep the area immediately surrounding and underneath the machine clean, neat, and free of debris and combustible materials. Make sure that the area overhead is clear of debris that could fall onto or into the machine or exhaust compartment.
- 2.1.18 ALWAYS be sure the machine is on a firm, level surface and will not tip, roll, slide, or fall while operating.
- 2.1.19 ALWAYS remove all tools, cords, and other loose items from the generator before starting it.
- 2.1.20 ALWAYS make certain the machine is well-grounded and securely fastened to a good earthen ground per national and local regulations.



BACKFEED FROM THE GENERATOR INTO THE PUBLIC POWER DISTRIBUTION SYSTEM CAN CAUSE SERIOUS INJURY OR DEATH TO UTILITY WORKERS!

Improper connection of generator to a building's electrical system can allow electrical current from the generator to backfeed into utility lines. This may result in electrocution of utility workers, fire, or explosion. Connections to a building's electrical system must be made by a qualified electrician and comply with all applicable laws and electrical codes.

If connected to a building's electrical system the generator must meet the power, voltage, and frequency requirements of the equipment in the building. Differences in power, voltage, and frequency requirements may exist and improper connection may lead to equipment damage, fire, and personal injury or death.

2.2 Service Safety



WARNING

A poorly maintained machine can become a safety hazard! In order for the machine to operate safely and properly over a long period of time, periodic maintenance and occasional repairs are necessary.

2.2.1 NEVER perform even routine service (oil/filter changes, cleaning, etc.) unless all electrical components are shut down. Before servicing this machine, make sure the engine start switch is turned to off “O”, the circuit breakers are open (off), the emergency stop switch is closed (pushed in), and the negative terminal on battery is disconnected. Attach a “DO NOT START” sign to the control panel. This will notify everyone that the unit is being serviced and will reduce the chance of someone inadvertently trying to start the unit. If the unit is connected to a remote start or transfer switch, make sure the remote switch is also off and tagged.

2.2.2 Ground Connection

The generator must be connected to a good earthen ground for proper operating safety!

A central “equipment ground” is provided at the customer connection lugs. This point is connected directly to the generator set base. All other system grounds are connected to this central point. Ground the generator in accordance with the standards defined in national, state and local regulations.

2.2.3 DO NOT attempt to open the radiator cap while the unit is running or before the engine has cooled down. Severe burns may result!

2.2.4 DO NOT allow water to accumulate around the base of the machine. If water is present, move the machine and allow the machine to dry before servicing.

2.2.5 DO NOT service the machine if your clothing or skin is wet.

2.2.6 DO NOT allow untrained personnel to service this equipment. Only trained electrical technicians should be allowed to service the electrical components of this equipment.

2.2.7 DO NOT modify the machine without the express written approval of the manufacturer.

2.2.8 DO NOT pressure wash the control panel, generator end, or any other electrical components when cleaning the unit. Never allow water to accumulate around the base of the generator set. If water is present, DO NOT service!

2.2.9 ALWAYS replace the safety devices and guards after repairs and maintenance.

2.2.10 ALWAYS let the engine cool before transporting or servicing it.

- 2.2.11 ALWAYS remain aware of moving parts and keep hands, feet, and loose clothing away from the moving parts of the machine.
- 2.2.12 ALWAYS replace all guards, fasten doors and make sure all safety devices operate properly after making repairs or servicing the equipment.
- 2.2.13 ALWAYS keep hands, feet, and loose clothing away from the moving parts on the generator and engine.
- 2.2.14 ALWAYS keep the machine clean and labels legible. Replace all missing and hard-to-read labels. Labels provide important operating instructions and warn of dangers and hazards.
- 2.2.15 ALWAYS check all external fasteners at regular intervals.
- 2.2.16 ALWAYS make sure slings, chains, hooks, ramps, jacks and other types of lifting devices are attached securely and have enough weight-bearing capacity to lift or hold the machine safely. Always remain aware of the location of other people in the area when lifting the machine.

2.3 Operator Safety while using Internal Combustion Engines



Internal combustion engines present special hazards during operation and fueling. Read and follow the warning instructions in the engine Owner's Manual and the safety guidelines below. Failure to follow the warnings and safety standards could result in severe injury or death.

- 2.3.1 DO NOT run engine indoors or in an area with poor ventilation unless exhaust hoses are used.
- 2.3.2 DO NOT fill or drain the fuel tank near an open flame, while smoking, or while the engine is running.
- 2.3.3 DO NOT refuel a hot or running engine.
- 2.3.4 ALWAYS refill the fuel tank in a well-ventilated area.
- 2.3.5 DO NOT touch or lean against hot exhaust pipes.
- 2.3.6 ALWAYS replace the fuel tank cap after refueling.
- 2.3.7 DO NOT start the engine if fuel has spilled or a fuel odor is present. Move the generator away from the spill and wipe the generator dry before starting.
- 2.3.8 DO NOT remove the radiator cap when the engine is running or hot. The radiator fluid is hot and under pressure and may cause severe burns!

2.4 Towing Safety



Towing a large trailer requires special care. Both the trailer and vehicle must be in good condition and securely fastened to each other to reduce the possibility of an accident.

- 2.4.1 ALWAYS check that the hitch and coupling on the vehicle are rated equal to, or greater than, the trailer's "gross vehicle weight rating" (GVWR).
- 2.4.2 ALWAYS inspect the hitch and coupling for wear or damage. DO NOT tow the trailer using defective parts.
- 2.4.3 ALWAYS make sure the coupling is securely fastened to the vehicle.
- 2.4.4 ALWAYS check the tires on the trailer for tread wear, inflation, and condition. Replace worn tires.
- 2.4.5 ALWAYS connect the safety chains.
- 2.4.6 ALWAYS connect the breakaway cable safety hook to the bumper or rear of the vehicle. DO NOT attach it to the hitch.
- 2.4.7 ALWAYS test the surge brakes on the trailer and the brakes on the vehicle that will be used for towing.
- 2.4.8 ALWAYS make sure directional and trailer lights are connected and working properly.
- 2.4.9 ALWAYS check that the lug nuts holding the wheels are tight and that none are missing.

2.5 Reporting Trailer Safety Defects

If you believe your trailer has a defect which could cause a crash or could cause injury or death, you should immediately inform the National Highway Traffic Safety Administration (NHTSA) in addition to notifying Wacker Corporation.

If NHTSA receives similar complaints, it may open an investigation; and if it finds that a safety defect exists in a group of vehicles, it may order a recall and remedy campaign. However, NHTSA cannot become involved in individual problems between you, your dealer, or Wacker Corporation.

To contact NHTSA, you may either contact the Auto Safety Hotline toll-free at 1-800-424-9393 (or 366-0129 in Washington DC area), www.nhtsa.com, or write to NHTSA, U.S. Department of Transportation, 400 7th Street SW, (NSA-11), Washington, DC 20590. You can also obtain other information about motor vehicle safety from the Auto Safety Hotline.

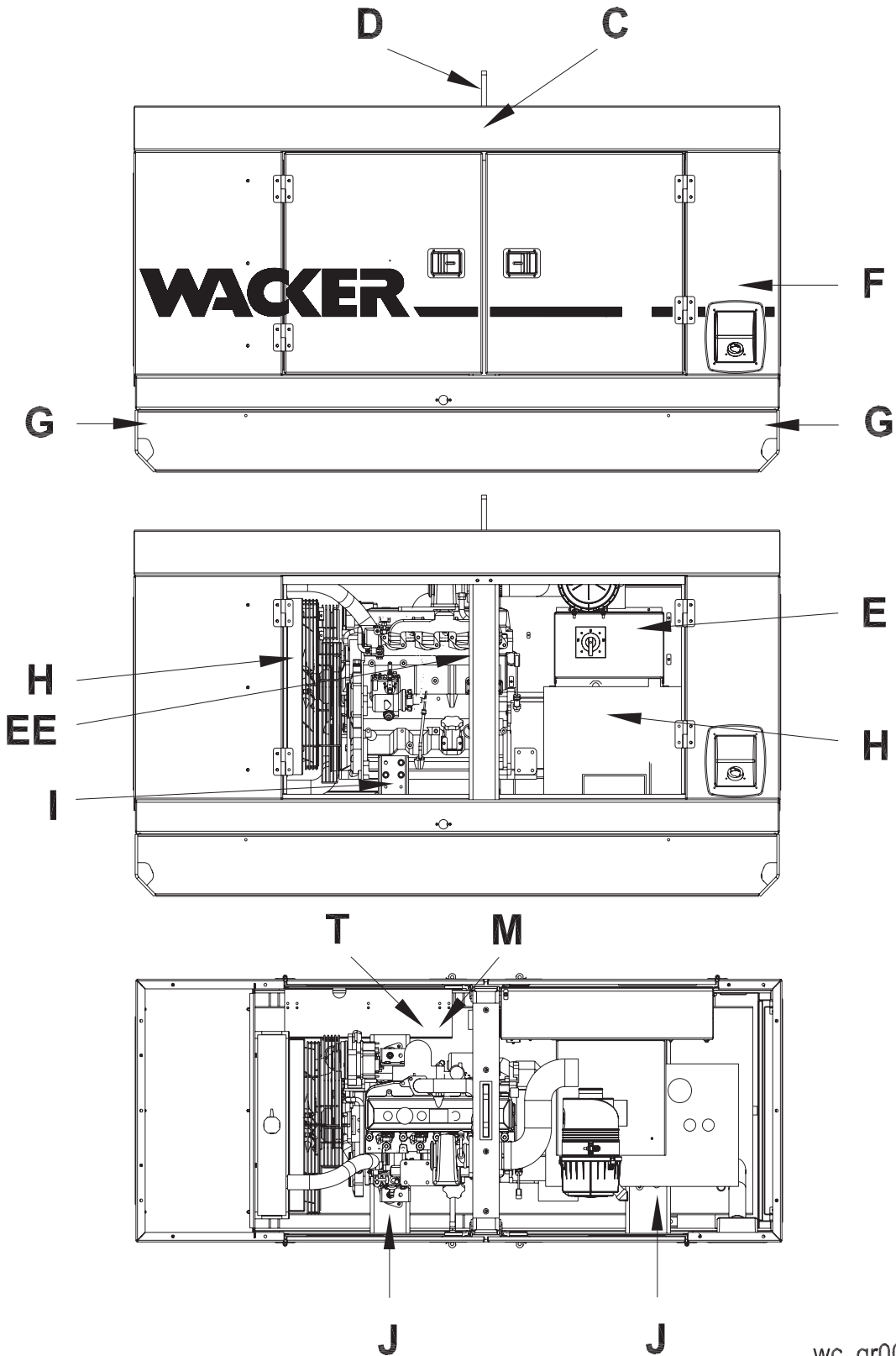

2.6 Label Location



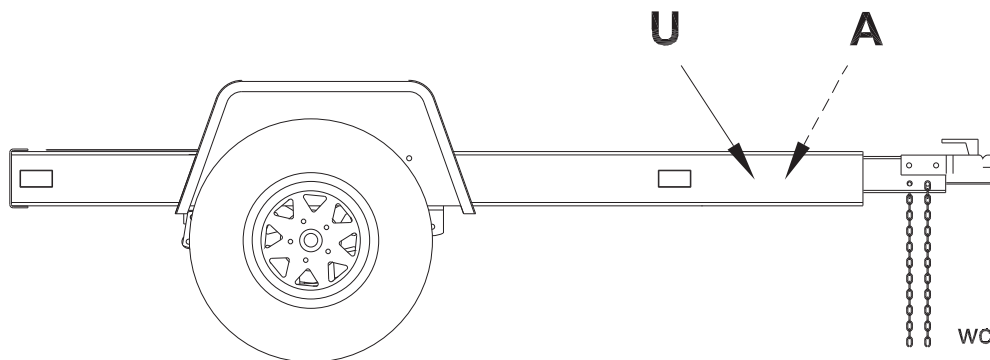
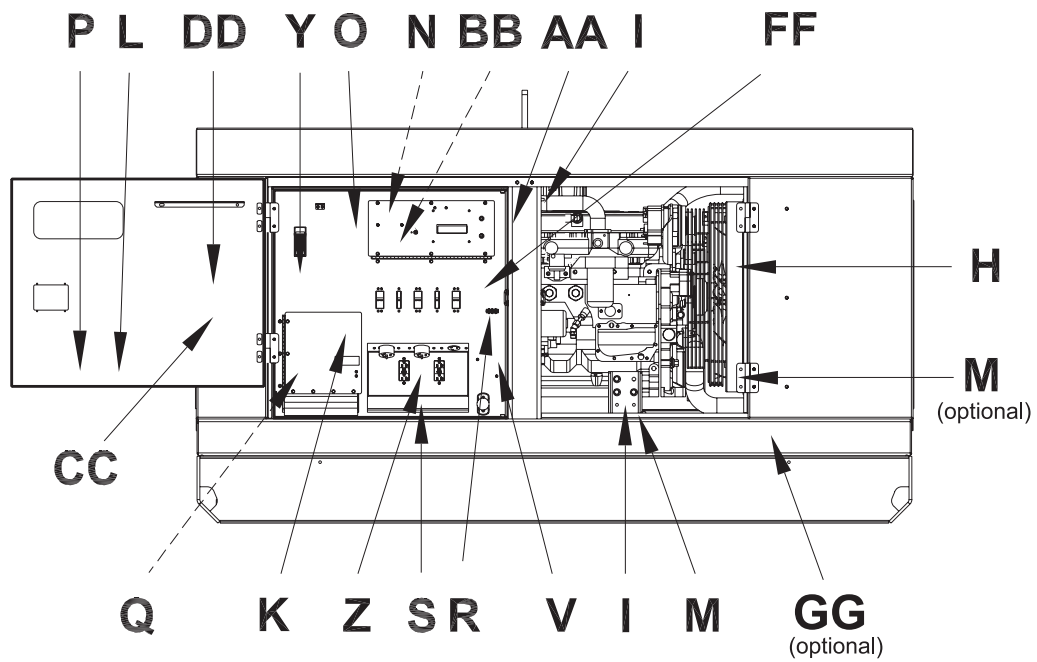
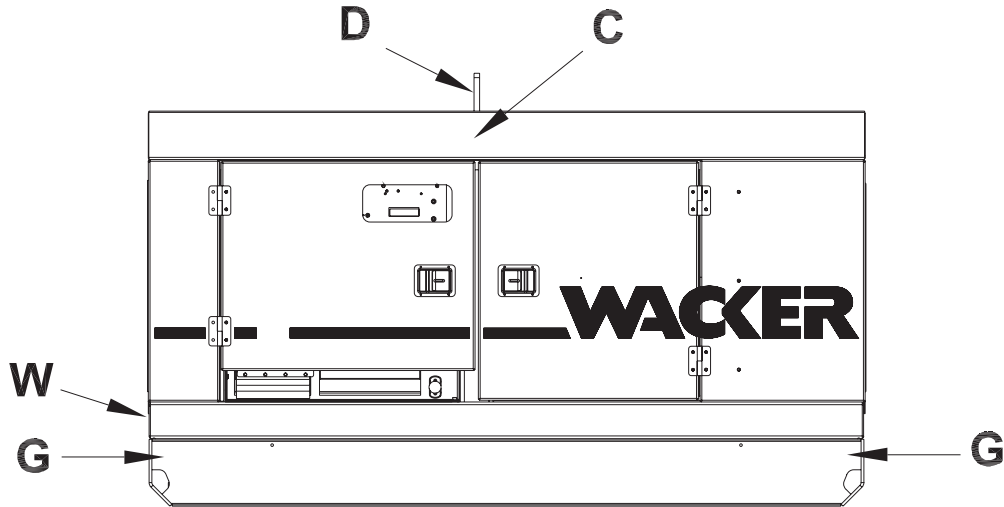



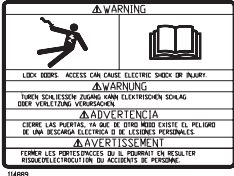

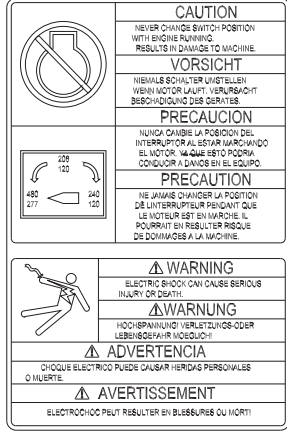
wc_gr002609



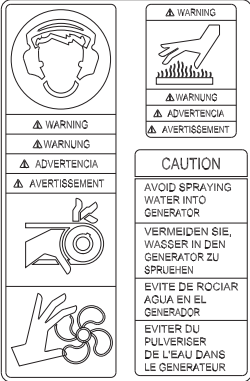

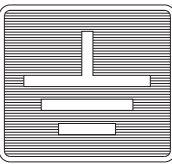
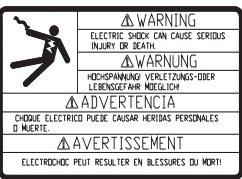

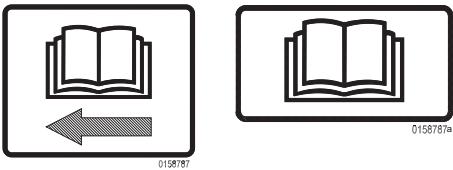
2.7 Safety and Operating Labels



Ref.	Label	Meaning								
A	<table border="1" style="width:100%; border-collapse: collapse;"> <thead> <tr> <th style="width:25%;">TOWING INSTRUCTIONS</th> <th style="width:25%;">ABSCHLEPPINSTRUKTIONEN</th> <th style="width:25%;">INSTRUCCIONES DE REMOLQUE</th> <th style="width:25%;">INSTRUCTIONS DE REMORQUAGE</th> </tr> </thead> <tbody> <tr> <td style="font-size: 8px;"> 1. READ OPERATOR'S MANUAL. 2. USE HITCH RATED FROM TRAILER'S "GROSS VEHICLE WEIGHT RATING". 3. SECURELY ATTACH TRAILER TO TOW VEHICLE. 4. ATTACH SAFETY CHAINS USING CROSS PATTERN. 5. ATTACH BREAKDOWN CHAIN TO VEHICLE. 6. CHECK TRAILER LIGHTS. </td> <td style="font-size: 8px;"> 1. BETRIEBSVORSCHRIFT LESEN. 2. ANHANGEVORRICHTUNG VERWENDEN, DIE DER GESAMTBETRIEBSGEWICHTSKLASSE ENTSPRICHT. 3. ANHÄNGER SICHER AM ZUGFAHRZEUG BEFESTIGEN. 4. SICHERHEITSKETTEN KREUZWEISE ANBRINGEN. 5. ABREISSKETTE AM FAHRZEUG ANBRINGEN. 6. ANHÄNGERLEUCHTEN PRÜFEN. </td> <td style="font-size: 8px;"> 1. LEA EL MANUAL DEL OPERARIO. 2. UTILICE UN ACOPLE CORRECTAMENTE CLASIFICADO PARA LA "CLASE DE PESO BRUTO" DEL VEHICULO DEL REMOLQUE. 3. ASEGURESE DE AMARRAR CORRECTAMENTE EL REMOLQUE AL VEHICULO DE REMOLQUE. 4. FUE EN CRUZ LAS CADENAS DE SEGURIDAD. 5. ABREISSKETTE AM FAHRZEUG ANBRINGEN. 6. CONTROLE LAS LUCES DEL REMOLQUE. </td> <td style="font-size: 8px;"> 1. LIRE LA NOTICE D'EMPLOI. 2. UTILISER UN GROCHET D'ATTACHE CONFORME AU DEBIT NOMINAL DU POIDS BRUT DE VEHICULE DU TRACTEUR. 3. ATTACHER LA REMORQUE FERMEMENT AU VEHICULE TRACTEUR. 4. ATTACHER LES CHAINES DE SURETTE EN UTILISANT UNE METHODE CROISEE. 5. ATTACHER LA CHAÎNE DE REMORQUAGE AU VEHICULE. 6. VERIFIER LES LAMPES DE LA REMORQUE. </td> </tr> </tbody> </table>	TOWING INSTRUCTIONS	ABSCHLEPPINSTRUKTIONEN	INSTRUCCIONES DE REMOLQUE	INSTRUCTIONS DE REMORQUAGE	1. READ OPERATOR'S MANUAL. 2. USE HITCH RATED FROM TRAILER'S "GROSS VEHICLE WEIGHT RATING". 3. SECURELY ATTACH TRAILER TO TOW VEHICLE. 4. ATTACH SAFETY CHAINS USING CROSS PATTERN. 5. ATTACH BREAKDOWN CHAIN TO VEHICLE. 6. CHECK TRAILER LIGHTS.	1. BETRIEBSVORSCHRIFT LESEN. 2. ANHANGEVORRICHTUNG VERWENDEN, DIE DER GESAMTBETRIEBSGEWICHTSKLASSE ENTSPRICHT. 3. ANHÄNGER SICHER AM ZUGFAHRZEUG BEFESTIGEN. 4. SICHERHEITSKETTEN KREUZWEISE ANBRINGEN. 5. ABREISSKETTE AM FAHRZEUG ANBRINGEN. 6. ANHÄNGERLEUCHTEN PRÜFEN.	1. LEA EL MANUAL DEL OPERARIO. 2. UTILICE UN ACOPLE CORRECTAMENTE CLASIFICADO PARA LA "CLASE DE PESO BRUTO" DEL VEHICULO DEL REMOLQUE. 3. ASEGURESE DE AMARRAR CORRECTAMENTE EL REMOLQUE AL VEHICULO DE REMOLQUE. 4. FUE EN CRUZ LAS CADENAS DE SEGURIDAD. 5. ABREISSKETTE AM FAHRZEUG ANBRINGEN. 6. CONTROLE LAS LUCES DEL REMOLQUE.	1. LIRE LA NOTICE D'EMPLOI. 2. UTILISER UN GROCHET D'ATTACHE CONFORME AU DEBIT NOMINAL DU POIDS BRUT DE VEHICULE DU TRACTEUR. 3. ATTACHER LA REMORQUE FERMEMENT AU VEHICULE TRACTEUR. 4. ATTACHER LES CHAINES DE SURETTE EN UTILISANT UNE METHODE CROISEE. 5. ATTACHER LA CHAÎNE DE REMORQUAGE AU VEHICULE. 6. VERIFIER LES LAMPES DE LA REMORQUE.	
TOWING INSTRUCTIONS	ABSCHLEPPINSTRUKTIONEN	INSTRUCCIONES DE REMOLQUE	INSTRUCTIONS DE REMORQUAGE							
1. READ OPERATOR'S MANUAL. 2. USE HITCH RATED FROM TRAILER'S "GROSS VEHICLE WEIGHT RATING". 3. SECURELY ATTACH TRAILER TO TOW VEHICLE. 4. ATTACH SAFETY CHAINS USING CROSS PATTERN. 5. ATTACH BREAKDOWN CHAIN TO VEHICLE. 6. CHECK TRAILER LIGHTS.	1. BETRIEBSVORSCHRIFT LESEN. 2. ANHANGEVORRICHTUNG VERWENDEN, DIE DER GESAMTBETRIEBSGEWICHTSKLASSE ENTSPRICHT. 3. ANHÄNGER SICHER AM ZUGFAHRZEUG BEFESTIGEN. 4. SICHERHEITSKETTEN KREUZWEISE ANBRINGEN. 5. ABREISSKETTE AM FAHRZEUG ANBRINGEN. 6. ANHÄNGERLEUCHTEN PRÜFEN.	1. LEA EL MANUAL DEL OPERARIO. 2. UTILICE UN ACOPLE CORRECTAMENTE CLASIFICADO PARA LA "CLASE DE PESO BRUTO" DEL VEHICULO DEL REMOLQUE. 3. ASEGURESE DE AMARRAR CORRECTAMENTE EL REMOLQUE AL VEHICULO DE REMOLQUE. 4. FUE EN CRUZ LAS CADENAS DE SEGURIDAD. 5. ABREISSKETTE AM FAHRZEUG ANBRINGEN. 6. CONTROLE LAS LUCES DEL REMOLQUE.	1. LIRE LA NOTICE D'EMPLOI. 2. UTILISER UN GROCHET D'ATTACHE CONFORME AU DEBIT NOMINAL DU POIDS BRUT DE VEHICULE DU TRACTEUR. 3. ATTACHER LA REMORQUE FERMEMENT AU VEHICULE TRACTEUR. 4. ATTACHER LES CHAINES DE SURETTE EN UTILISANT UNE METHODE CROISEE. 5. ATTACHER LA CHAÎNE DE REMORQUAGE AU VEHICULE. 6. VERIFIER LES LAMPES DE LA REMORQUE.							
B		<p>WARNING! Pressurized contents. Do not open when hot!</p>								
C		<p>WARNING! Lock doors. Access can cause electric shock or injury.</p>								
D		<p>CAUTION! Lifting point.</p>								
E		<p>CAUTION! Never change switch position with engine running. Results in damage to machine.</p> <p>WARNING! Electric shock will cause serious injury or death.</p>								

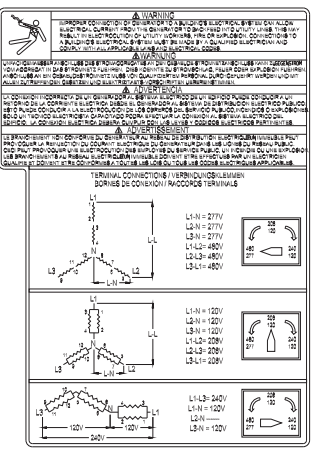

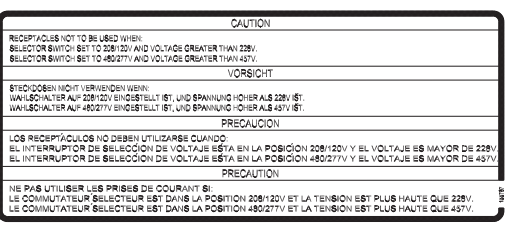
Ref.	Label	Meaning
F		<p>DANGER! Asphyxiation hazard. Read the Operator's Manual for instructions. No sparks, flames, or burning objects near machine. Stop the engine before adding fuel. Use only diesel fuel.</p>
G		<p>Tie-down point.</p>
H		<p>WARNING! To prevent hearing loss, wear hearing protection. Hand injury if entangled in moving belt. Rotating machinery! Do not reach inside with engine running. WARNING! Hot surface! CAUTION! Avoid spraying water into generator.</p>
I		<p>WARNING! Hot surface!</p>
J		<p>Electrical ground</p>
K		<p>WARNING! Electric shock will cause serious injury or death.</p>

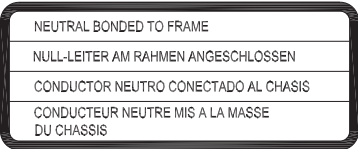

Ref.	Label	Meaning							
L	<table border="1" style="width: 100%; border-collapse: collapse;"> <tr> <td style="width: 50%; padding: 5px;"> <p style="text-align: center;">OPERATING INSTRUCTIONS FOR MOBILE GENERATORS</p> <p>BEFORE STARTING</p> <ol style="list-style-type: none"> 1. READ OPERATOR'S MANUAL. 2. LEVEL UNIT. 3. BLOCK WHEELS. 4. GROUND UNIT. 5. CHECK ALL FLUID LEVELS. <p>MANUAL STARTING</p> <ol style="list-style-type: none"> 1. DISCONNECT ALL EXTERNAL LOADS. 2. SET VOLTAGE SELECTOR SWITCH. 3. LOCK VOLTAGE SELECTOR SWITCH. (#2 & #3 NOT INCLUDED ON G12) 4. TURN EMERGENCY STOP BUTTON TO "ON" POSITION. 5. PUSH ENGINE START SWITCH TO "START/RUN" POSITION. 6. ENGINE WILL MAKE 3 ATTEMPTS TO START. <p>REMOTE START</p> <ol style="list-style-type: none"> 1. SEE OPERATOR'S MANUAL. <p>STOPPING</p> <ol style="list-style-type: none"> 1. DISCONNECT ALL EXTERNAL LOADS. 2. PUSH ENGINE START SWITCH TO "OFF" POSITION. 3. FILL FUEL TANK. </td> <td style="width: 50%; padding: 5px;"> <p style="text-align: center;">BETRIEBSANLEITUNG FÜR MOBILEAGGREGATE</p> <p>VOR DEM STARTEN</p> <ol style="list-style-type: none"> 1. BETRIEBSVORSCHRIFT LESEN. 2. GERÄT WAAGRECHT STELLEN. 3. RÄDER BLOCKIEREN. 4. GERÄT ERDEN. 5. STAND ALLER FLÜSSIGKEITEN PRÜFEN. <p>HANDSTARTEN</p> <ol style="list-style-type: none"> 1. ALLE AUSSEREN BELASTUNGEN ABSCHALTEN. 2. SPANNUNGSWAHLSCHALTER SETZEN. 3. SPANNUNGSWAHLSCHALTER VERRIEGELN. (#2 & #3 NICHT EINGESCHLOSSEN MIT G12) 4. NOTSTOPKNOPF IN "ON" POSITION SETZEN. 5. MOTORSTARTSCHALTER AUF POSITION "START/LAUF" DRÜCKEN. 6. MOTOR VOLLZIEHT 3 STARTVERSUCHE. <p>FERNSTART</p> <ol style="list-style-type: none"> 1. SIEHE BETRIEBSVORSCHRIFT. <p>ABSCHALTEN</p> <ol style="list-style-type: none"> 1. ALLE AUSSEREN BELASTUNGEN ABSCHALTEN. 2. MOTORSTARTSCHALTER AUF POSITION "OFF" DRÜCKEN. 3. KRAFTSTOFFTANK FÜLLEN. </td> </tr> <tr> <td style="width: 50%; padding: 5px;"> <p style="text-align: center;">INSTRUCCIONES PARA LA PUESTA EN MARCHA DE GENERADORES MOVILES</p> <p>ANTES DEL ARRANQUE</p> <ol style="list-style-type: none"> 1. LEA EL MANUAL DEL OPERARIO. 2. NIVELE LA UNIDAD. 3. COLOQUE CUNAS DEBAJO DE LAS RUEDAS. 4. CONECTE LA UNIDAD A TIERRA. 5. CONTROLE TODOS LOS LIQUIDOS. <p>ARRANQUE MANUAL</p> <ol style="list-style-type: none"> 1. DESCONECTE TODAS LAS CARGAS EXTERNAS. 2. AJUSTE LA LLAVE SELECTORA DE VOLTAJE. 3. BLOQUEE LA LLAVE SELECTORA DE VOLTAJE. (#2 & #3 NO ESTA INCLUIDO CON G12) 4. GIRE A LA POSICION "ON" EL BOTON DE PARADA DE EMERGENCIA. 5. OPRIMA A LA POSICION "ARRANQUE/MARCHA" EL INTERRUPTOR DE ARRANQUE DEL MOTOR. 6. EL MOTOR INTENTARA ARRANCAR 3 VECES. <p>ARRANQUE REMOTO</p> <ol style="list-style-type: none"> 1. VEA EL MANUAL DEL OPERARIO. <p>DETENCION DEL MOTOR</p> <ol style="list-style-type: none"> 1. DESCONECTE TODAS LAS CARGAS EXTERNAS. 2. OPRIMA A LA POSICION "OFF" EL INTERRUPTOR DE ARRANQUE DEL MOTOR. 3. LLENE EL TANQUE DE COMBUSTIBLE. </td> <td style="width: 50%; padding: 5px;"> <p style="text-align: center;">INSTRUCTIONS D'OPERATION DU GENERATEUR MOBILE</p> <p>AVANT LE DEMARRAGE</p> <ol style="list-style-type: none"> 1. LIRE LA NOTICE D'EMPLOI. 2. NIVELE LA MACHINE. 3. BLOQUER LES ROUES AVEC CALES DE ROUES. 4. METTRE A TERRE LA MACHINE. 5. VERIFIER LE NIVEAU DE TOUTS LES FLUIDES. <p>DEMARRAGE A LA MAIN</p> <ol style="list-style-type: none"> 1. DECONNECTER TOUS LES REGIMES EXTERNES. 2. REGLER LE COMMUTEUR DES TENSIONS D'ALIMENTATION. 3. SERRER LE COMMUTEUR DES TENSIONS D'ALIMENTATION. (#2 & #3 PAS COMPRIS AVEC G12) 4. TOURNER LE BOUTON D'URGENCE A LA POSITION "ON". 5. PRESSER LE BOUTON DE DEMARRAGE DU MOTEUR A LA POSITION "DEMARRAGE/MARCHE". 6. LE MOTEUR ESSAYERA DE DEMARRER 3 FOIS. <p>DEMARRAGE A DISTANCE</p> <ol style="list-style-type: none"> 1. LIRE LA NOTICE D'EMPLOI. <p>ARRET</p> <ol style="list-style-type: none"> 1. DECONNECTER TOUS LES REGIMES EXTERNES. 2. PRESSER LE BOUTON DE DEMARRAGE DU MOTEUR A LA POSITION "OFF". 3. REMPLIR LE RESERVOIR A CARBURANT. </td> </tr> <tr> <td style="width: 25%; padding: 5px;"> <p>OPERATOR'S MANUAL MUST BE STORED ON MACHINE.</p> <p>REPLACEMENT OPERATOR'S MANUAL CAN BE ORDERED THROUGH YOUR LOCAL WACKER DISTRIBUTOR.</p> </td> <td style="width: 25%; padding: 5px;"> <p>DIE BETRIEBSVORSCHRIFT MUSS AN DER MASCHINE AUFBEWAHRT WERDEN.-ZUR BESTELLUNG VON ERSATZBUCHERN WENDEN SIE SICH BITTE AN IHREN ORTLICHEN WACKER HANDLER.</p> </td> <td style="width: 50%; padding: 5px;"> <p>EL MANUAL DE OPERACION DEBE SER RETENIDO EN LA MAQUINA. CONTACTE A SU DISTRIBUIDOR WACKER MAS CERCAO PARA PEDIR UN EJEMPLAR ADICIONAL.</p> <p>LA NOTICE D'EMPLOI DOIT ETRE MUNIE SUR LA MACHINE. CONTACTER LE DISTRIBUTEUR WACKER LE PLUS PROCHE POUR COMMANDER UN EXEMPLAIRE SUPPLEMENTAIRE.</p> </td> </tr> </table>	<p style="text-align: center;">OPERATING INSTRUCTIONS FOR MOBILE GENERATORS</p> <p>BEFORE STARTING</p> <ol style="list-style-type: none"> 1. READ OPERATOR'S MANUAL. 2. LEVEL UNIT. 3. BLOCK WHEELS. 4. GROUND UNIT. 5. CHECK ALL FLUID LEVELS. <p>MANUAL STARTING</p> <ol style="list-style-type: none"> 1. DISCONNECT ALL EXTERNAL LOADS. 2. SET VOLTAGE SELECTOR SWITCH. 3. LOCK VOLTAGE SELECTOR SWITCH. (#2 & #3 NOT INCLUDED ON G12) 4. TURN EMERGENCY STOP BUTTON TO "ON" POSITION. 5. PUSH ENGINE START SWITCH TO "START/RUN" POSITION. 6. ENGINE WILL MAKE 3 ATTEMPTS TO START. <p>REMOTE START</p> <ol style="list-style-type: none"> 1. SEE OPERATOR'S MANUAL. <p>STOPPING</p> <ol style="list-style-type: none"> 1. DISCONNECT ALL EXTERNAL LOADS. 2. PUSH ENGINE START SWITCH TO "OFF" POSITION. 3. FILL FUEL TANK. 	<p style="text-align: center;">BETRIEBSANLEITUNG FÜR MOBILEAGGREGATE</p> <p>VOR DEM STARTEN</p> <ol style="list-style-type: none"> 1. BETRIEBSVORSCHRIFT LESEN. 2. GERÄT WAAGRECHT STELLEN. 3. RÄDER BLOCKIEREN. 4. GERÄT ERDEN. 5. STAND ALLER FLÜSSIGKEITEN PRÜFEN. <p>HANDSTARTEN</p> <ol style="list-style-type: none"> 1. ALLE AUSSEREN BELASTUNGEN ABSCHALTEN. 2. SPANNUNGSWAHLSCHALTER SETZEN. 3. SPANNUNGSWAHLSCHALTER VERRIEGELN. (#2 & #3 NICHT EINGESCHLOSSEN MIT G12) 4. NOTSTOPKNOPF IN "ON" POSITION SETZEN. 5. MOTORSTARTSCHALTER AUF POSITION "START/LAUF" DRÜCKEN. 6. MOTOR VOLLZIEHT 3 STARTVERSUCHE. <p>FERNSTART</p> <ol style="list-style-type: none"> 1. SIEHE BETRIEBSVORSCHRIFT. <p>ABSCHALTEN</p> <ol style="list-style-type: none"> 1. ALLE AUSSEREN BELASTUNGEN ABSCHALTEN. 2. MOTORSTARTSCHALTER AUF POSITION "OFF" DRÜCKEN. 3. KRAFTSTOFFTANK FÜLLEN. 	<p style="text-align: center;">INSTRUCCIONES PARA LA PUESTA EN MARCHA DE GENERADORES MOVILES</p> <p>ANTES DEL ARRANQUE</p> <ol style="list-style-type: none"> 1. LEA EL MANUAL DEL OPERARIO. 2. NIVELE LA UNIDAD. 3. COLOQUE CUNAS DEBAJO DE LAS RUEDAS. 4. CONECTE LA UNIDAD A TIERRA. 5. CONTROLE TODOS LOS LIQUIDOS. <p>ARRANQUE MANUAL</p> <ol style="list-style-type: none"> 1. DESCONECTE TODAS LAS CARGAS EXTERNAS. 2. AJUSTE LA LLAVE SELECTORA DE VOLTAJE. 3. BLOQUEE LA LLAVE SELECTORA DE VOLTAJE. (#2 & #3 NO ESTA INCLUIDO CON G12) 4. GIRE A LA POSICION "ON" EL BOTON DE PARADA DE EMERGENCIA. 5. OPRIMA A LA POSICION "ARRANQUE/MARCHA" EL INTERRUPTOR DE ARRANQUE DEL MOTOR. 6. EL MOTOR INTENTARA ARRANCAR 3 VECES. <p>ARRANQUE REMOTO</p> <ol style="list-style-type: none"> 1. VEA EL MANUAL DEL OPERARIO. <p>DETENCION DEL MOTOR</p> <ol style="list-style-type: none"> 1. DESCONECTE TODAS LAS CARGAS EXTERNAS. 2. OPRIMA A LA POSICION "OFF" EL INTERRUPTOR DE ARRANQUE DEL MOTOR. 3. LLENE EL TANQUE DE COMBUSTIBLE. 	<p style="text-align: center;">INSTRUCTIONS D'OPERATION DU GENERATEUR MOBILE</p> <p>AVANT LE DEMARRAGE</p> <ol style="list-style-type: none"> 1. LIRE LA NOTICE D'EMPLOI. 2. NIVELE LA MACHINE. 3. BLOQUER LES ROUES AVEC CALES DE ROUES. 4. METTRE A TERRE LA MACHINE. 5. VERIFIER LE NIVEAU DE TOUTS LES FLUIDES. <p>DEMARRAGE A LA MAIN</p> <ol style="list-style-type: none"> 1. DECONNECTER TOUS LES REGIMES EXTERNES. 2. REGLER LE COMMUTEUR DES TENSIONS D'ALIMENTATION. 3. SERRER LE COMMUTEUR DES TENSIONS D'ALIMENTATION. (#2 & #3 PAS COMPRIS AVEC G12) 4. TOURNER LE BOUTON D'URGENCE A LA POSITION "ON". 5. PRESSER LE BOUTON DE DEMARRAGE DU MOTEUR A LA POSITION "DEMARRAGE/MARCHE". 6. LE MOTEUR ESSAYERA DE DEMARRER 3 FOIS. <p>DEMARRAGE A DISTANCE</p> <ol style="list-style-type: none"> 1. LIRE LA NOTICE D'EMPLOI. <p>ARRET</p> <ol style="list-style-type: none"> 1. DECONNECTER TOUS LES REGIMES EXTERNES. 2. PRESSER LE BOUTON DE DEMARRAGE DU MOTEUR A LA POSITION "OFF". 3. REMPLIR LE RESERVOIR A CARBURANT. 	<p>OPERATOR'S MANUAL MUST BE STORED ON MACHINE.</p> <p>REPLACEMENT OPERATOR'S MANUAL CAN BE ORDERED THROUGH YOUR LOCAL WACKER DISTRIBUTOR.</p>	<p>DIE BETRIEBSVORSCHRIFT MUSS AN DER MASCHINE AUFBEWAHRT WERDEN.-ZUR BESTELLUNG VON ERSATZBUCHERN WENDEN SIE SICH BITTE AN IHREN ORTLICHEN WACKER HANDLER.</p>	<p>EL MANUAL DE OPERACION DEBE SER RETENIDO EN LA MAQUINA. CONTACTE A SU DISTRIBUIDOR WACKER MAS CERCAO PARA PEDIR UN EJEMPLAR ADICIONAL.</p> <p>LA NOTICE D'EMPLOI DOIT ETRE MUNIE SUR LA MACHINE. CONTACTER LE DISTRIBUTEUR WACKER LE PLUS PROCHE POUR COMMANDER UN EXEMPLAIRE SUPPLEMENTAIRE.</p>	
<p style="text-align: center;">OPERATING INSTRUCTIONS FOR MOBILE GENERATORS</p> <p>BEFORE STARTING</p> <ol style="list-style-type: none"> 1. READ OPERATOR'S MANUAL. 2. LEVEL UNIT. 3. BLOCK WHEELS. 4. GROUND UNIT. 5. CHECK ALL FLUID LEVELS. <p>MANUAL STARTING</p> <ol style="list-style-type: none"> 1. DISCONNECT ALL EXTERNAL LOADS. 2. SET VOLTAGE SELECTOR SWITCH. 3. LOCK VOLTAGE SELECTOR SWITCH. (#2 & #3 NOT INCLUDED ON G12) 4. TURN EMERGENCY STOP BUTTON TO "ON" POSITION. 5. PUSH ENGINE START SWITCH TO "START/RUN" POSITION. 6. ENGINE WILL MAKE 3 ATTEMPTS TO START. <p>REMOTE START</p> <ol style="list-style-type: none"> 1. SEE OPERATOR'S MANUAL. <p>STOPPING</p> <ol style="list-style-type: none"> 1. DISCONNECT ALL EXTERNAL LOADS. 2. PUSH ENGINE START SWITCH TO "OFF" POSITION. 3. FILL FUEL TANK. 	<p style="text-align: center;">BETRIEBSANLEITUNG FÜR MOBILEAGGREGATE</p> <p>VOR DEM STARTEN</p> <ol style="list-style-type: none"> 1. BETRIEBSVORSCHRIFT LESEN. 2. GERÄT WAAGRECHT STELLEN. 3. RÄDER BLOCKIEREN. 4. GERÄT ERDEN. 5. STAND ALLER FLÜSSIGKEITEN PRÜFEN. <p>HANDSTARTEN</p> <ol style="list-style-type: none"> 1. ALLE AUSSEREN BELASTUNGEN ABSCHALTEN. 2. SPANNUNGSWAHLSCHALTER SETZEN. 3. SPANNUNGSWAHLSCHALTER VERRIEGELN. (#2 & #3 NICHT EINGESCHLOSSEN MIT G12) 4. NOTSTOPKNOPF IN "ON" POSITION SETZEN. 5. MOTORSTARTSCHALTER AUF POSITION "START/LAUF" DRÜCKEN. 6. MOTOR VOLLZIEHT 3 STARTVERSUCHE. <p>FERNSTART</p> <ol style="list-style-type: none"> 1. SIEHE BETRIEBSVORSCHRIFT. <p>ABSCHALTEN</p> <ol style="list-style-type: none"> 1. ALLE AUSSEREN BELASTUNGEN ABSCHALTEN. 2. MOTORSTARTSCHALTER AUF POSITION "OFF" DRÜCKEN. 3. KRAFTSTOFFTANK FÜLLEN. 								
<p style="text-align: center;">INSTRUCCIONES PARA LA PUESTA EN MARCHA DE GENERADORES MOVILES</p> <p>ANTES DEL ARRANQUE</p> <ol style="list-style-type: none"> 1. LEA EL MANUAL DEL OPERARIO. 2. NIVELE LA UNIDAD. 3. COLOQUE CUNAS DEBAJO DE LAS RUEDAS. 4. CONECTE LA UNIDAD A TIERRA. 5. CONTROLE TODOS LOS LIQUIDOS. <p>ARRANQUE MANUAL</p> <ol style="list-style-type: none"> 1. DESCONECTE TODAS LAS CARGAS EXTERNAS. 2. AJUSTE LA LLAVE SELECTORA DE VOLTAJE. 3. BLOQUEE LA LLAVE SELECTORA DE VOLTAJE. (#2 & #3 NO ESTA INCLUIDO CON G12) 4. GIRE A LA POSICION "ON" EL BOTON DE PARADA DE EMERGENCIA. 5. OPRIMA A LA POSICION "ARRANQUE/MARCHA" EL INTERRUPTOR DE ARRANQUE DEL MOTOR. 6. EL MOTOR INTENTARA ARRANCAR 3 VECES. <p>ARRANQUE REMOTO</p> <ol style="list-style-type: none"> 1. VEA EL MANUAL DEL OPERARIO. <p>DETENCION DEL MOTOR</p> <ol style="list-style-type: none"> 1. DESCONECTE TODAS LAS CARGAS EXTERNAS. 2. OPRIMA A LA POSICION "OFF" EL INTERRUPTOR DE ARRANQUE DEL MOTOR. 3. LLENE EL TANQUE DE COMBUSTIBLE. 	<p style="text-align: center;">INSTRUCTIONS D'OPERATION DU GENERATEUR MOBILE</p> <p>AVANT LE DEMARRAGE</p> <ol style="list-style-type: none"> 1. LIRE LA NOTICE D'EMPLOI. 2. NIVELE LA MACHINE. 3. BLOQUER LES ROUES AVEC CALES DE ROUES. 4. METTRE A TERRE LA MACHINE. 5. VERIFIER LE NIVEAU DE TOUTS LES FLUIDES. <p>DEMARRAGE A LA MAIN</p> <ol style="list-style-type: none"> 1. DECONNECTER TOUS LES REGIMES EXTERNES. 2. REGLER LE COMMUTEUR DES TENSIONS D'ALIMENTATION. 3. SERRER LE COMMUTEUR DES TENSIONS D'ALIMENTATION. (#2 & #3 PAS COMPRIS AVEC G12) 4. TOURNER LE BOUTON D'URGENCE A LA POSITION "ON". 5. PRESSER LE BOUTON DE DEMARRAGE DU MOTEUR A LA POSITION "DEMARRAGE/MARCHE". 6. LE MOTEUR ESSAYERA DE DEMARRER 3 FOIS. <p>DEMARRAGE A DISTANCE</p> <ol style="list-style-type: none"> 1. LIRE LA NOTICE D'EMPLOI. <p>ARRET</p> <ol style="list-style-type: none"> 1. DECONNECTER TOUS LES REGIMES EXTERNES. 2. PRESSER LE BOUTON DE DEMARRAGE DU MOTEUR A LA POSITION "OFF". 3. REMPLIR LE RESERVOIR A CARBURANT. 								
<p>OPERATOR'S MANUAL MUST BE STORED ON MACHINE.</p> <p>REPLACEMENT OPERATOR'S MANUAL CAN BE ORDERED THROUGH YOUR LOCAL WACKER DISTRIBUTOR.</p>	<p>DIE BETRIEBSVORSCHRIFT MUSS AN DER MASCHINE AUFBEWAHRT WERDEN.-ZUR BESTELLUNG VON ERSATZBUCHERN WENDEN SIE SICH BITTE AN IHREN ORTLICHEN WACKER HANDLER.</p>	<p>EL MANUAL DE OPERACION DEBE SER RETENIDO EN LA MAQUINA. CONTACTE A SU DISTRIBUIDOR WACKER MAS CERCAO PARA PEDIR UN EJEMPLAR ADICIONAL.</p> <p>LA NOTICE D'EMPLOI DOIT ETRE MUNIE SUR LA MACHINE. CONTACTER LE DISTRIBUTEUR WACKER LE PLUS PROCHE POUR COMMANDER UN EXEMPLAIRE SUPPLEMENTAIRE.</p>							
M		<p>Operator's Manual must be stored on machine. Replacement Operator's Manual can be ordered through your local Wacker distributor.</p>							
N		<p>DANGER! Electric shock will cause serious injury or death. Danger of asphyxiation!</p>							

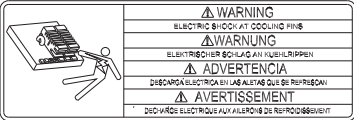
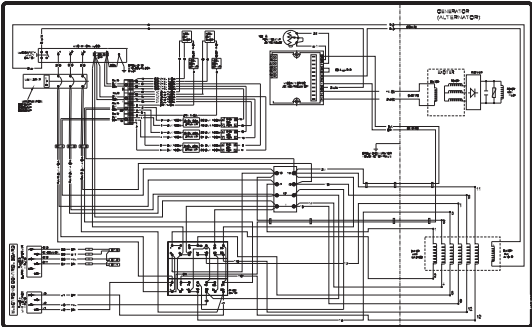
Ref.	Label	Meaning									
O	 <p>⚠ WARNING GENERATOR CAN AUTOMATICALLY START WHICH CAN CAUSE SERIOUS INJURY. DISCONNECT BATTERY BEFORE SERVICING.</p> <p>⚠ WARNING AGGREGAT KAN AUTOMATISCH STARTEN UND VORPERLICHE VERLETZUNG VOR SERVICING BEIHT. BATTERIE ABLEBEN.</p> <p>⚠ ADVERTENCIA GENERADOR PUEDE ARRINCAR AUTOMÁTICAMENTE Y CAUSAR LESIONES PERSONALES. DESCONECTE LA BATERIA ANTES DE PRESTAR SERVICIO.</p> <p>⚠ AVERTISSEMENT GÉNÉRATEUR PEUT DÉMARRER AUTOMATIQUEMENT RÉSULTANT EN DES ACCIDENTS DE PERSONNE. DÉCONNECTEZ LA BATTERIE AVANT TOUT ENTRETIEN.</p>	<p>WARNING! Generator can automatically start which can cause serious injury. Disconnect battery before servicing.</p>									
P	 <p>⚠ WARNING READ AND UNDERSTAND THE SUPPLIED OPERATOR'S MANUAL BEFORE OPERATING THIS MACHINE. FAILURE TO DO SO INCREASES THE RISK OF INJURY TO YOURSELF OR OTHERS.</p> <p>⚠ WARNING VOR INBETRIEBNAHME DIESER GERÄTES BEI DER NUTZUNG DES BEDIENERSCHULUNG ERHÖHT DAS RISKO ZU SCHWEREN VERLETZUNGEN ODER ANDEREN UNGLÜCKEN.</p> <p>⚠ ADVERTENCIA LEA Y ENTIENDA EL MANUAL DE OPERACION PROPORCIONADO CON EL EQUIPO ANTES DE QUE OPERE ESTE EQUIPO. DE NO HACERSE ASÍ, PODRÁ AUMENTAR EL RIESGO DE DAÑOS PERSONALES Y A OTRAS PERSONAS.</p> <p>⚠ AVERTISSEMENT LIRE ET COMPRENDS LA NOTICE D'UTILISATION FOURNIE AVEC LA MACHINE AVANT DE LA METTRE EN SERVICE. S'IL NE LE FAIT PAS, VOUS AUGMENTEZ LE RISQUE DE VOUS EXPOSER ET LES AUTRES A DES BLESSURES.</p>	<p>WARNING! Read and understand the supplied Operator's Manual before operating the machine. Failure to do so increases the risk of injury to yourself or others.</p>									
Q	 <p>⚠ WARNING TO REDUCE THE RISK OF ELECTRICAL SHOCK, READ THE OPERATOR'S MANUAL. IMPROPER CONNECTION OF THE GENERATOR TO A BUILDING'S ELECTRICAL SYSTEM CAN ALLOW ELECTRICAL CURRENT FROM THE GENERATOR TO BACKFEED INTO UTILITY LINES. THIS MAY RESULT IN ELECTROCUTION OF UTILITY WORKERS, FIRE OR EXPLOSION. CONNECTIONS TO A BUILDING'S ELECTRICAL SYSTEM MUST BE MADE BY A QUALIFIED ELECTRICIAN AND COMPLY WITH ALL APPLICABLE LAWS AND ELECTRICAL CODES.</p> <p>⚠ AVERTISSEMENT POUR RÉDUIRE LE RISQUE DE CHOC ÉLECTRIQUE, LIRE ET COMPRENDRE LA NOTICE D'UTILISATION FOURNIE AVEC LA MACHINE. UNE MAUVAISE RÉGULATION DU GÉNÉRATEUR PEUT PERMETTRE AU COURANT ÉLECTRIQUE DE REVENIR DANS LES LIGNES D'UTILITÉ. CE QUI PEUT CAUSER LA MORT, DES BLESSURES GRAVES, DES INCENDIES OU DES EXPLOSIONS. LES RACCORDEMENTS À UN SYSTÈME ÉLECTRIQUE D'UN BÂTIMENT DOIVENT ÊTRE RÉALISÉS PAR UN ÉLECTRICIEN QUALIFIÉ ET ÊTRE EN CONFORMITÉ AVEC LES LOIS ET LES NORMES EN VIGUEUR.</p> <p>TERMINAL CONNECTIONS / ENRIENOS DE CONEXIÓN TERMINALES</p> <table border="1"> <tr> <td></td> <td>L1-N = 277V L2-N = 277V L3-N = 277V L1-L2 = 480V L2-L3 = 480V L3-L1 = 480V</td> <td></td> </tr> <tr> <td></td> <td>L1-N = 120V L2-N = 120V L3-N = 120V L1-L2 = 208V L2-L3 = 208V L3-L1 = 208V</td> <td></td> </tr> <tr> <td></td> <td>L1-L2 = 240V L1-N = 120V L2-N = 120V L3-N = 120V</td> <td></td> </tr> </table>		L1-N = 277V L2-N = 277V L3-N = 277V L1-L2 = 480V L2-L3 = 480V L3-L1 = 480V			L1-N = 120V L2-N = 120V L3-N = 120V L1-L2 = 208V L2-L3 = 208V L3-L1 = 208V			L1-L2 = 240V L1-N = 120V L2-N = 120V L3-N = 120V		<p>WARNING! To reduce the risk of electrical shock, read the operator's manual. Improper connection of the generator to a building's electrical system can allow electrical current from the generator to backfeed into utility lines. This may result in electrocution of utility workers, fire or explosion. Connections to a building's electrical system must be made by a qualified electrician and comply with all applicable laws and electrical codes.</p>
	L1-N = 277V L2-N = 277V L3-N = 277V L1-L2 = 480V L2-L3 = 480V L3-L1 = 480V										
	L1-N = 120V L2-N = 120V L3-N = 120V L1-L2 = 208V L2-L3 = 208V L3-L1 = 208V										
	L1-L2 = 240V L1-N = 120V L2-N = 120V L3-N = 120V										
R	 <p>REMOTE START FERNSTART ARRANQUE REMOTO DEMARRAGE A DISTANCE</p>	<p>Remote start operation. Read operator's manual for instructions.</p>									
S	 <p>CAUTION</p> <p>RECEPTACLES NOT TO BE USED WHEN: SELECTOR SWITCH SET TO 208/120V AND VOLTAGE GREATER THAN 228V. SELECTOR SWITCH SET TO 480/277V AND VOLTAGE GREATER THAN 457V.</p> <p>VORSICHT</p> <p>STRECKDOSEN NICHT VERWENDEN WENN: WAHLWECHSEL AUF 208/120V SINDSTELLT IST, UND SPANNUNG HÖHER ALS 228V IST. WAHLWECHSEL AUF 480/277V SINDSTELLT IST, UND SPANNUNG HÖHER ALS 457V IST.</p> <p>PRECAUCIÓN</p> <p>LOS RECEPTÁCULOS NO DEBEN UTILIZARSE CUANDO: EL INTERRUPTOR DE SELECCIÓN DE VOLTAJE ESTÁ EN LA POSICIÓN 208/120V Y EL VOLTAJE ES MAYOR DE 228V. EL INTERRUPTOR DE SELECCIÓN DE VOLTAJE ESTÁ EN LA POSICIÓN 480/277V Y EL VOLTAJE ES MAYOR DE 457V.</p> <p>PRECAUTION</p> <p>NE PAS UTILISER LES PRISES DE COURANT SI: LE COMMANTEUR-SELECTEUR EST DANS LA POSITION 208/120V ET LA TENSION EST PLUS HAUTE QUE 228V. LE COMMANTEUR-SELECTEUR EST DANS LA POSITION 480/277V ET LA TENSION EST PLUS HAUTE QUE 457V.</p>	<p>CAUTION! Receptacles not to be used when: Selector switch set to 208/120V and voltage greater than 228V. Selector switch set to 480/277V and voltage greater than 457V.</p>									

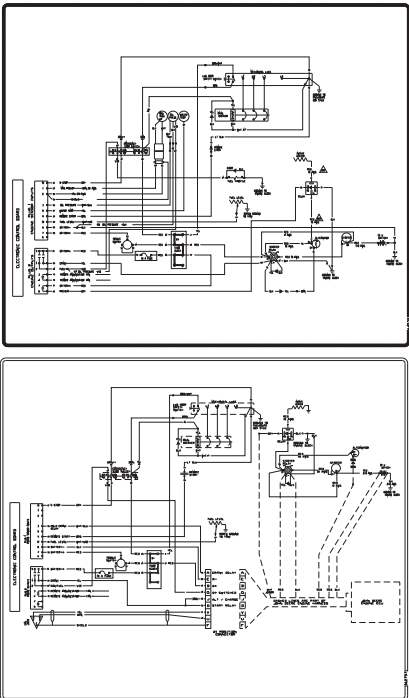
Ref.	Label	Meaning								
T		<p>WARNING! Disconnect battery before servicing. Read the Operator's Manual.</p>								
U	<table border="1"> <thead> <tr> <th>TRAILER WIRING</th> <th>ANHÄNGER-VERDRAHTUNG</th> <th>CANALISATION ELECTRICA DE REMOLQUE</th> <th>DISPOSITION DES CABLES POUR REMORQUE</th> </tr> </thead> <tbody> <tr> <td> G - RIGHT BRAKE LIGHT AND DIRECTIONAL Y - LEFT BRAKE LIGHT AND DIRECTIONAL Br - TAIL, SIDE AND LICENSE PLATE LIGHTS W - GROUND L - ELECTRIC BRAKES B - BATTERY CHARGE </td> <td> G - RECHTES BREMSLICHT UND BLINKER Y - LINKES BREMSLICHT UND BLINKER Br - SCHLUSS-, SEITEN- UND KENNZEICHENLEUCHTE W - ERDUNG L - ELEKTRISCHE BREMSE B - BATTERIE-LADUNG </td> <td> G - LUZ FRENO Y GIRO DERECHA Y - LUZ FRENO Y GIRO IZQUIERDA Br - LUZ TRASERA, LATERAL Y PLACA DE MATRICULA W - TIERRA L - FRENS ELECTRICOS B - CARGA BATERIA </td> <td> G - FEUX DE STOP ET DE DIRECTION D Y - FEUX DE STOP ET DE DIRECTION G Br - FEUX D'ARRIERE, DE POSITION ET DE PLAQUE D'IMMATRICULATION W - MISE A TERRE L - FREINS ELECTRIQUES B - CHARGE DE LA BATTERIE </td> </tr> </tbody> </table>	TRAILER WIRING	ANHÄNGER-VERDRAHTUNG	CANALISATION ELECTRICA DE REMOLQUE	DISPOSITION DES CABLES POUR REMORQUE	G - RIGHT BRAKE LIGHT AND DIRECTIONAL Y - LEFT BRAKE LIGHT AND DIRECTIONAL Br - TAIL, SIDE AND LICENSE PLATE LIGHTS W - GROUND L - ELECTRIC BRAKES B - BATTERY CHARGE	G - RECHTES BREMSLICHT UND BLINKER Y - LINKES BREMSLICHT UND BLINKER Br - SCHLUSS-, SEITEN- UND KENNZEICHENLEUCHTE W - ERDUNG L - ELEKTRISCHE BREMSE B - BATTERIE-LADUNG	G - LUZ FRENO Y GIRO DERECHA Y - LUZ FRENO Y GIRO IZQUIERDA Br - LUZ TRASERA, LATERAL Y PLACA DE MATRICULA W - TIERRA L - FRENS ELECTRICOS B - CARGA BATERIA	G - FEUX DE STOP ET DE DIRECTION D Y - FEUX DE STOP ET DE DIRECTION G Br - FEUX D'ARRIERE, DE POSITION ET DE PLAQUE D'IMMATRICULATION W - MISE A TERRE L - FREINS ELECTRIQUES B - CHARGE DE LA BATTERIE	
TRAILER WIRING	ANHÄNGER-VERDRAHTUNG	CANALISATION ELECTRICA DE REMOLQUE	DISPOSITION DES CABLES POUR REMORQUE							
G - RIGHT BRAKE LIGHT AND DIRECTIONAL Y - LEFT BRAKE LIGHT AND DIRECTIONAL Br - TAIL, SIDE AND LICENSE PLATE LIGHTS W - GROUND L - ELECTRIC BRAKES B - BATTERY CHARGE	G - RECHTES BREMSLICHT UND BLINKER Y - LINKES BREMSLICHT UND BLINKER Br - SCHLUSS-, SEITEN- UND KENNZEICHENLEUCHTE W - ERDUNG L - ELEKTRISCHE BREMSE B - BATTERIE-LADUNG	G - LUZ FRENO Y GIRO DERECHA Y - LUZ FRENO Y GIRO IZQUIERDA Br - LUZ TRASERA, LATERAL Y PLACA DE MATRICULA W - TIERRA L - FRENS ELECTRICOS B - CARGA BATERIA	G - FEUX DE STOP ET DE DIRECTION D Y - FEUX DE STOP ET DE DIRECTION G Br - FEUX D'ARRIERE, DE POSITION ET DE PLAQUE D'IMMATRICULATION W - MISE A TERRE L - FREINS ELECTRIQUES B - CHARGE DE LA BATTERIE							
V		<p>Operator's Manual must be stored on machine. Replacement Operator's Manual can be ordered through your local Wacker distributor.</p>								
W		<p>Drain containment system.</p>								
X		<p>WARNING! To prevent hearing loss, wear hearing protection when operating the machine. WARNING! Pressurized contents. Do not open when hot! WARNING! Hand injury if entangled in moving belt. WARNING! Rotating machinery! Do not reach inside with engine running.</p>								
Y		<p>Operating the main circuit breaker supplies or interrupts power to the customer connection lugs.</p>								

Ref.	Label	Meaning
Z	 <p>NEUTRAL BONDED TO FRAME NULL-LEITER AM RAHMEN ANGESCHLOSSEN CONDUCTOR NEUTRO CONECTADO AL CHASIS CONDUCTEUR NEUTRE MIS A LA MASSE DU CHASSIS</p>	Neutral bonded to frame.
AA	 <p>FUSES SICHERUNGEN FUSIBLES FUSIBLES</p> <p>1 2 3 4</p>	<p>Fuses Read the operator's manual for machine information. 1 - Controller 2 - Not used 3 - Not used 4 - Not used</p>
BB	 <p>⚠ WARNING ELECTRIC SHOCK AT COOLING FINS ⚠ WARNUNG ELEKTROSTÖßER SICH AN KÜHLRIPPEN ⚠ ADVERTENCIA DESCARGA ELÉCTRICA EN LAS ALAS DE REFRIGERACIÓN ⚠ AVERTISSEMENT DÉCHARGE ÉLECTRIQUE AUX AILES DE RÉFROIDISSEMENT</p>	<p>WARNING! Electric shock at cooling fins.</p>
CC		<p>G 50 / G 70 / G 85 Generator and Receptacle Wiring</p>

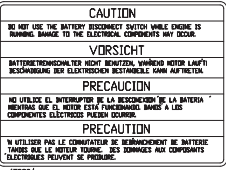
Ref.	Label	Meaning
DD		<p>G 50 / G 70 - Engine Wiring</p> <p>G 70 w/ECU & G 85 - Engine Wiring</p>
EE		<p>WARNING! Hot surface!</p>
FF		<p>A nameplate listing the model number, item number, revision number, and serial number is attached to each unit. Please record the information found on this plate so it will be available should the nameplate become lost or damaged. When ordering parts or requesting service information, you will always be asked to specify the model number, item number, revision number, and serial number of the unit.</p>

Ref.	Label	Meaning
GG		<p>CAUTION: Do not use battery disconnect switch while engine is running. Damage to electrical components may occur.</p>
		<p>This machine may be covered by one or more patents.</p>
		<p>Certification Label (VIN Number) Also attached to each unit is a Certification Label. This label specifies that the trailer conforms with all Federal Motor Vehicle Standards in effect at the time of manufacture. The label includes the Vehicle Identification Number (VIN) for the trailer.</p>

3. Operation

3.1 Control Panels

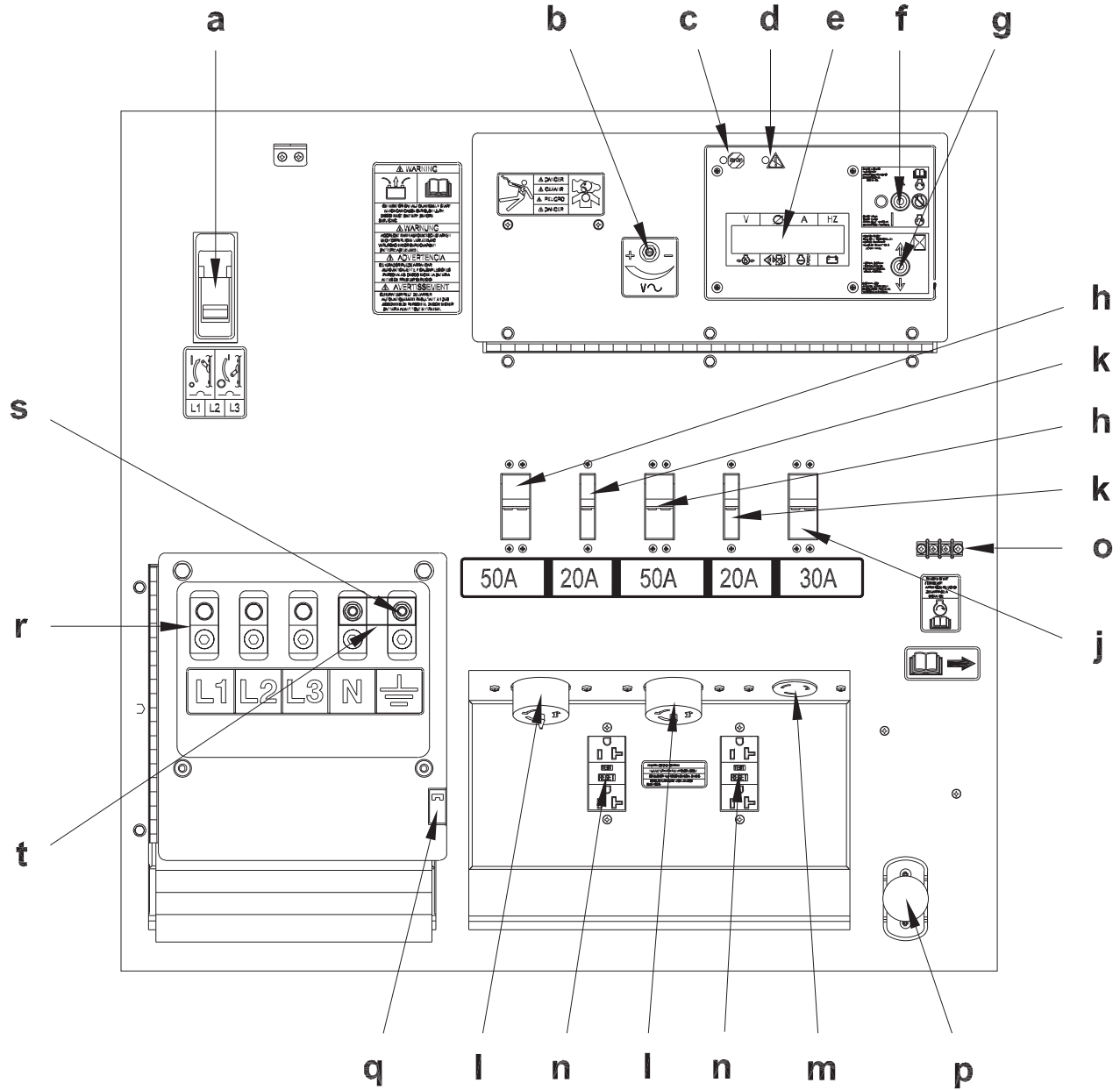

wc_gr002611

Ref.	Description	Ref.	Description
a	Main Circuit Breaker	l	Twist-Lock Receptacle (120/240 VAC, 50Amp) - two
b	Voltage Adjustment Rheostat	m	Twist-Lock Receptacle (120/240 VAC, 30 Amp)
c	Shutdown LED	n	GFI Receptacle (120 VAC, 20 Amp) - two
d	Pre-alarm LED	o	Remote Run Terminal Block
e	LCD Panel	p	Emergency Stop Switch
f	Engine Start Switch	q	Interlock Switch
g	Engine Hours Switch	r	Customer Connection Terminal Lugs
h	Circuit Breaker (240V, 50 Amp)	s	Ground Connection
j	Circuit Breaker (240V, 30 Amp)	t	Bond bar
k	Circuit Breaker (120V, 20 Amp) - two		

3.2 Generator Monitoring

Generator information is displayed on the top line of the LCD panel and is scrolled continuously while the generator is operating, to show the voltage, amperage and frequency of each phase.

Note: To prevent the display from scrolling, press the ENG HRS switch down.

Volts “V”- Displays the AC output voltage being produced by the generator.

Phase “Ø” - Indicates which phase is currently being displayed.

Amps “A” - Displays the AC output amperage produced by the generator. If the generator is operating at no-load, output amperage will display a 0.

Hertz “Hz” - Displays output frequency.

<table border="1"> <thead> <tr> <th>V</th> <th>Ø</th> <th>A</th> <th>HZ</th> </tr> </thead> <tbody> <tr> <td>208</td> <td>1</td> <td>24</td> <td>60</td> </tr> <tr> <td>78</td> <td>85%</td> <td>175</td> <td>14.3</td> </tr> <tr> <td></td> <td></td> <td></td> <td></td> </tr> </tbody> </table>	V	Ø	A	HZ	208	1	24	60	78	85%	175	14.3					<p>Sample display with engine running.</p>
V	Ø	A	HZ														
208	1	24	60														
78	85%	175	14.3														
<table border="1"> <thead> <tr> <th>V</th> <th>Ø</th> <th>A</th> <th>HZ</th> </tr> </thead> <tbody> <tr> <td colspan="4" style="text-align: center;">UNIT IN AUTO</td> </tr> <tr> <td>Ø</td> <td>100%</td> <td>85</td> <td>13.2</td> </tr> <tr> <td></td> <td></td> <td></td> <td></td> </tr> </tbody> </table>	V	Ø	A	HZ	UNIT IN AUTO				Ø	100%	85	13.2					<p>Sample display in “Auto” mode.</p>
V	Ø	A	HZ														
UNIT IN AUTO																	
Ø	100%	85	13.2														

3.3 Engine Monitoring

With the engine start switch set to “RUN/START” or “REMOTE START”, engine information will be continuously displayed on the bottom line of the LCD panel.

OIL  - Displays engine oil pressure. The gauge registers oil pressure between 0–100 psi. Normal operating pressure is between 60–80 psi. If oil pressure drops below 15 psi, the engine will automatically shut down.

FUEL  - Indicates the relative fuel level in the fuel tank. If fuel level drops to 5% the engine will automatically shut down.

TEMPERATURE  - Displays the temperature of the engine's coolant. If the coolant temperature gets too high, the engine will automatically shut down.

BATTERY  - This gauge measures the engine starting battery voltage. A normal reading is 13.5–14.5V. If the gauge falls much below or above these values, the engine charging system should be checked. With the engine switch set to “REMOTE START” and the generator in stand-by mode, actual battery voltage is displayed.

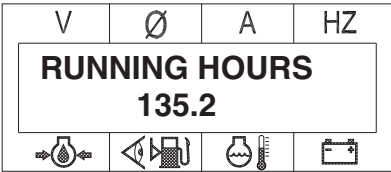
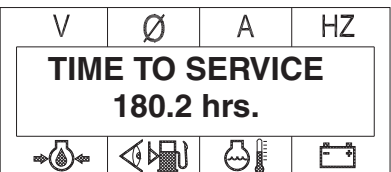
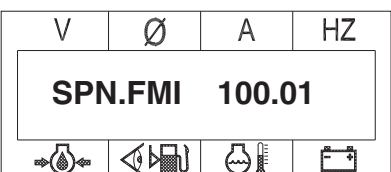

ENGINE HOURS  - Pressing the switch UP causes the engine's running hours, the periodic maintenance timer, and the Engine Diagnostic Trouble Codes set points to be displayed. Engine hours are accumulated only while the engine is actually running.

Note: *When held down, this switch can be used to lock in a specific display for a single phase.*

	<p>Sample display of engine hours.</p>
	<p>Sample display of periodic maintenance timer.</p>
	<p>G 85 & G 70 w/ECU only Sample display showing Engine Diagnostic Trouble Codes. SPN = Suspect Parameter Number FMI = Failure Mode Identifier.</p>

3.4 Engine Shutdown Faults

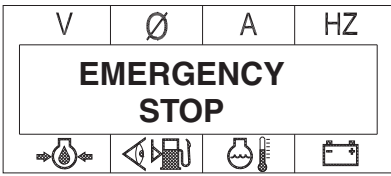
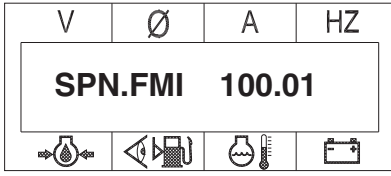
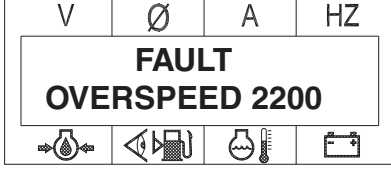
The engine control module (ECM) continuously monitors vital engine functions for fault conditions. When a fault condition occurs, the engine will shut down and the LCD panel will display the fault causing the shutdown. To reset the Engine Control Module and resume operation, return the Engine Start Switch manually to off “O”. Also refer to Section *Warning Light*.

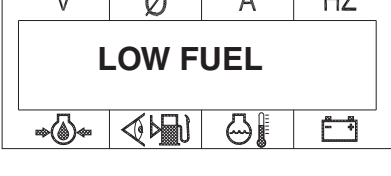
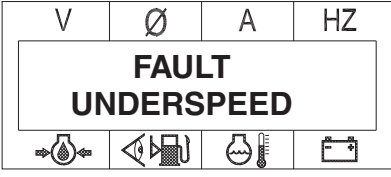
	<p>Indicates that the emergency stop button has been depressed. This display will remain on until the emergency stop button is pulled back out.</p>
	<p>G 70 w/ECU & G 85 only Sample display showing Engine Diagnostic Trouble Codes. SPN = Suspect Parameter Number FMI = Failure Mode Identifier.</p>
	<p>Indicates that the engine speed exceeded approximately 2000 rpm (110% of its rated speed of 1800 rpm) and the ECM has automatically shut the engine down.</p>
	<p>An overcrank fault is displayed when the engine fails to start during the normal cranking cycle, and the Engine Control Module has automatically shut down the generator due to an overcrank condition.</p>
	<p>A low fuel fault condition will be displayed when the fuel tank drops to 5% and the Engine Control Module has shut the engine down. This fault condition prevents the fuel lines from running completely dry and avoids the need to bleed the lines when the tank is refilled.</p>
	<p>Indicates that the engine speed dropped below 55 Hz for more than 15 seconds and the ECM has automatically shut the engine down.</p>

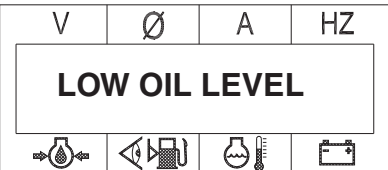
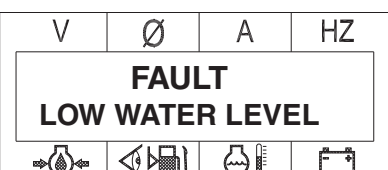
 <p>V Ø A HZ</p> <p>LOW OIL LEVEL</p>	<p>Normal operating pressure is between 40–80 psi. If oil pressure drops below 15 psi, the engine will automatically shut down.</p>
 <p>V Ø A HZ</p> <p>FAULT LOW WATER LEVEL</p>	<p>For machines with the Low-Coolant Shutdown Option only. This fault will be displayed when the ECM has picked up a signal from the sensor that a low-coolant level exists. During such a condition, the ECM shuts the engine down.</p>

3.5 Current Overload Fault

Along with engine functions the ECM continuously monitors the current load in each phase. The values for current overload are programmed into the ECM at the factory and are different for each generator size.

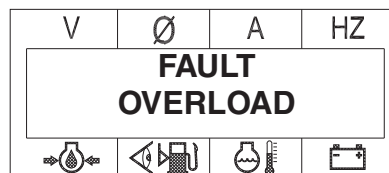

When an overload condition is sensed in any leg, the engine will shut down and the LCD panel will display the fault condition shown above.

Before restarting the generator, the cause of the overload should be determined and eliminated. Review all loads attached to the generator and make sure they do not exceed the power rating of the unit.

3.6 Application

Heavy-duty, compact, sound-attenuated generators designed to provide single and three-phase power for construction, commercial, and industrial applications where reliable power is needed.

NOTICE: Do not exceed the power output of the generator. Damage to tools or generator will occur. Refer to *Technical Data*.

When using the generator as a standby or substitute power supply, make sure the voltage and phase rotation of the line connections match those of the utility lines or of any other power source normally used. **Failure to match phase rotation and voltage may cause equipment connected to the generator to operate incorrectly! This could create unsafe operating conditions.**

NOTICE: DO NOT exceed the rated current limit of any receptacle.

3.7 Voltage Selector Switch

See Graphic: *wc_gr001682*

The voltage selector switch is located in a separate enclosure on the generator on the opposite side of the machine.

The selector switch is a three-position switch which mechanically changes the connections between the generator output leads and the terminal lugs on the generator. This allows three different volt ranges to be selected.

120/240 VAC 1Ø

120/208 VAC 3Ø

139/240 VAC 3Ø (Refer to Section *Voltage Adjustment Rheostat*.)

277/480 VAC 3Ø

Voltage ranges are selected by rotating the handle on the switch to the desired voltage. The switch is equipped with a locking mechanism. This allows the voltage setting to be locked in place to prevent unauthorized personnel from changing the voltage selection. To lock switch in position, push lock up and attach a padlock through the openings in the locking strip.

NOTICE: NEVER CHANGE THE VOLTAGE SELECTOR SWITCH WITH THE ENGINE RUNNING. This can cause arcing and can severely damage the switch and the generator windings.



DANGER OF ELECTROCUTION! High voltage is present inside this panel when the generator is operating!

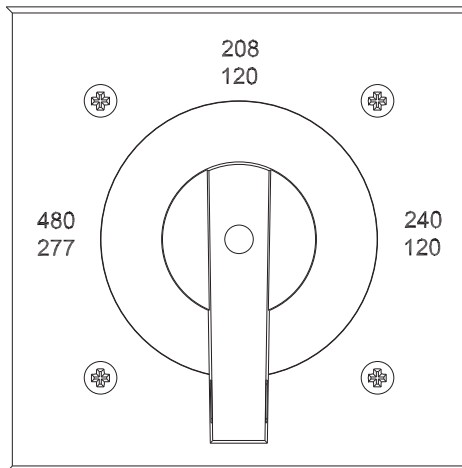

	CAUTION NEVER CHANGE SWITCH POSITION WITH ENGINE RUNNING. RESULTS IN DAMAGE TO MACHINE.
	VORSICHT NIEMALS SCHALTER UMSTELLEN WENN MOTOR LAUFT. VERURSACHT BESCHÄDIGUNG DES GERÄTES.
	PRECAUCION NUNCA CAMBIE LA POSICION DEL INTERRUPTOR AL ESTAR MARCANDO EL MOTOR. PUEDE SER DAÑADA CONDUCTOR A DAÑOS EN EL EQUIPO.
	PRECAUCION NE JAMAIS CHANGER LA POSITION DE L'INTERRUPTEUR PENDANT QUE LE MOTEUR EST EN MARCHE. IL POURRAIT EN RESULTER DES DANGERS A LA MACHINE.

	⚠ DANGER ELECTRIC SHOCK WILL CAUSE SERIOUS INJURY OR DEATH.
	⚠ GEFAHR HOCHSPANNUNG! VERLETZUNGS- ODER LEBENSGEFAHR!
	⚠ PELIGRO CHOCQUE ELECTRICO PODRIA CAUSAR HERIDAS PERSONALES O MUERTE.
⚠ DANGER ELECTROCUTION POURRAIT RESULTER EN BLESSURES OU MORT!	

wc_gr001682

3.8 Emergency Stop Switch

See Graphic: *wc_gr001677*

The emergency stop switch (**p**) is the red button located below the receptacle panel and can be accessed with the panel doors closed.

Activate the emergency stop switch by pushing the red button in. Pushing the emergency stop switch opens the main circuit breaker and the fuel solenoid and results in the engine shutting down. The switch will remain in until the button is rotated and it pops out.

NOTICE: PRESS THE EMERGENCY STOP BUTTON ONLY IN THE CASE OF AN ACTUAL EMERGENCY WHERE THE GENERATOR MUST BE STOPPED IMMEDIATELY! In all other instances, open the main line circuit breaker and then turn the engine start switch to off "O".

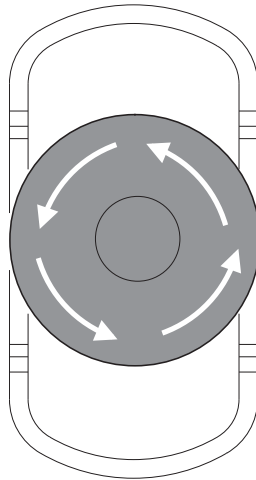

wc_gr001677

3.9 Main Line Circuit Breaker

See Graphic: wc_gr002611

The main line circuit breaker (a) is located on the control panel.

In the “off” position, this breaker interrupts power from the selector switch to the terminal lugs at the bottom of the generator panel.

NOTICE: Before shutting down the generator or performing any service to the generator unit, make sure the main circuit breaker is in the off “O” position.

NOTICE: The convenience receptacles are not connected through the main line circuit breaker but are connected directly to the generator windings. As a result, the receptacles are powered even with the main breaker in the “off” position. To turn off power to receptacles, open the individual circuit breakers provided for each.



DANGER OF ELECTROCUTION! High voltage is present inside this panel when the generator is operating!

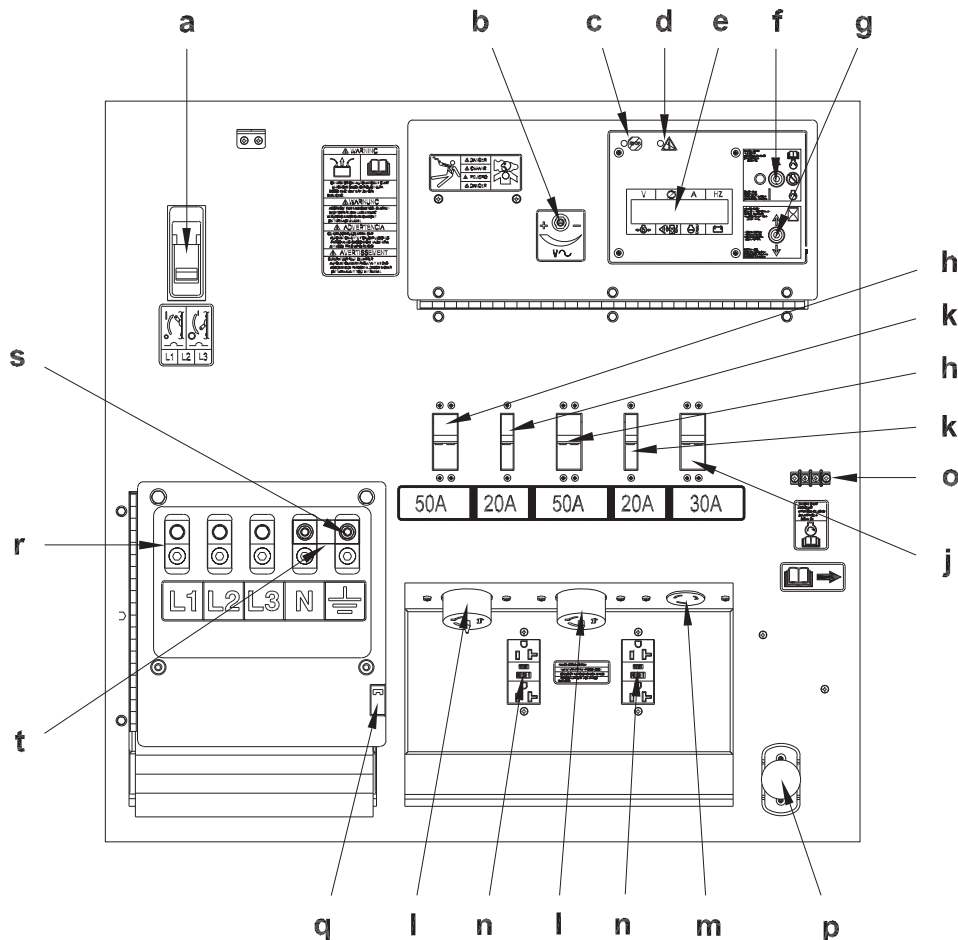

wc_gr002611

3.10 Engine Start Switch

See Graphic: *wc_gr002611*

The engine start switch **(f)** is a three-position switch: “REMOTE START”, off “O”, and “START/RUN”. The “REMOTE START” position is the normal setting used when using the generator as a back-up power supply connected to a remote switch. In the REMOTE START position, the generator is in stand-by mode and will not start until the remote switch closes. In the “START/RUN” position, the switch immediately starts the engine start cycle and activates the starter motor to crank the engine. When set in the “REMOTE START” or “START/RUN” position, the switch applies battery power to the control module to turn on the LCD panel, and also energizes the engine’s electrical system. In the off “O” position, power to the engine’s electrical system, including the fuel solenoid, is disconnected.

3.11 Voltage Adjustment Rheostat

See Graphic: *wc_gr002611*

Just left of the controller display window is the voltage adjustment rheostat **(b)**. Use the rheostat to adjust the AC voltage output. Loosen locking nut and turn adjusting screw clockwise to increase voltage, counter-clockwise to decrease voltage. The voltage can be monitored at the LCD panel.

3.12 Warning Light

See Graphic: *wc_gr002611*

The amber warning light **(d)** on the metering panel will turn on prior to an engine fault condition occurring. This acts as a pre-alarm to call attention to a potential fault condition. At the same time the warning light goes on, the LCD panel will begin blinking to indicate which engine function is approaching its fault value.

Engine Pre-alarm Set Points:

- Fuel Level = 25%
- High Temperature = 226°F
- Low Oil Pressure = 20 psi
- Time to Service = 0 hours
- Sender Failure = engine coolant and oil pressure senders.

Note: Time to Service and Sender Failure faults will not shut down the generator.

3.13 Connection Lugs

See Graphic: wc_gr002611

The customer connection lugs (r) are located on left at the bottom of the panel behind a hinged door. The lugs provide connection points for attachment of outside loads.

A large label like the one shown in section *Terminal Connections* is attached to the inside of the terminal door. It shows the correct terminal connections for selected voltages.

Connections to the lugs should be made by running the power cables up under the lug door in the bottom of the panel and into the lug. Use a 3/8 in. Allen wrench to tighten cable connections in place.



DANGER OF ELECTROCUTION! High voltage is present inside this panel when the generator is operating!

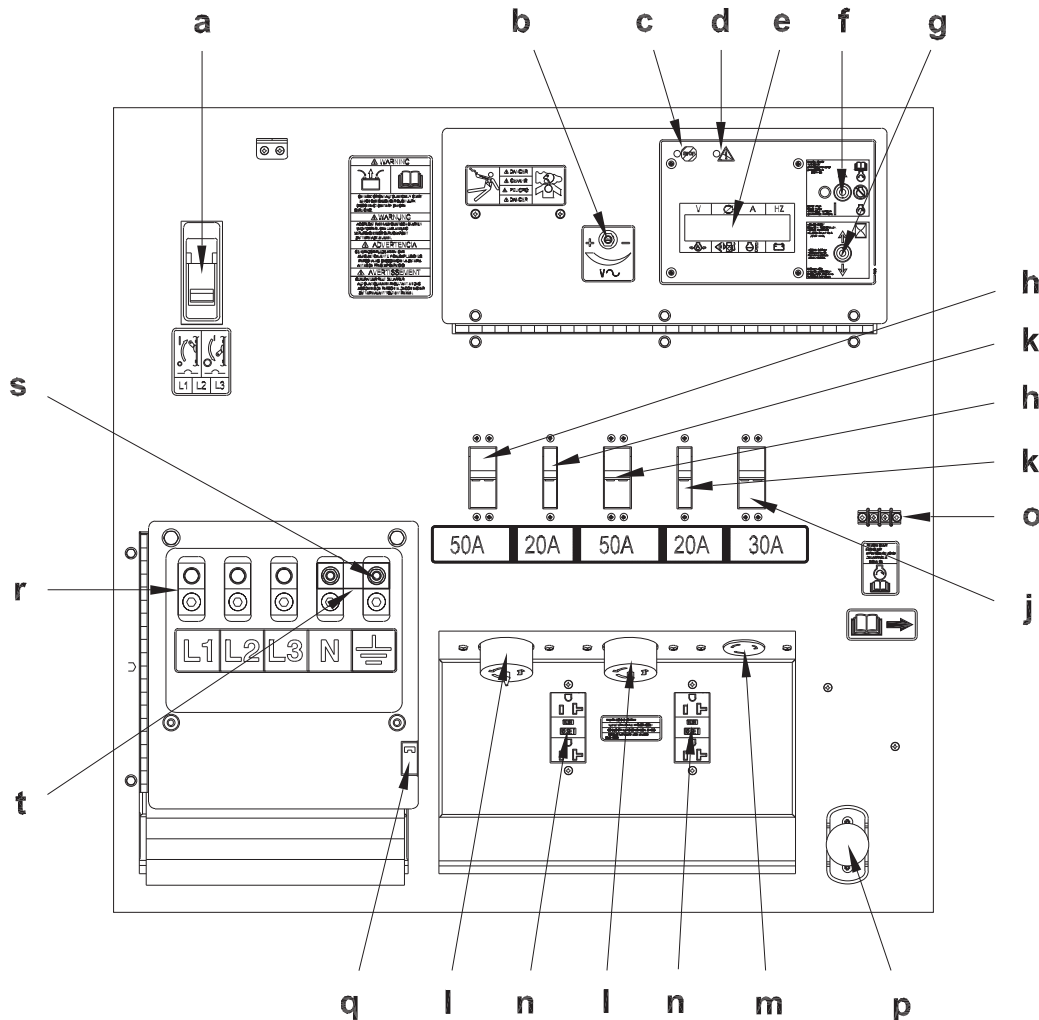

wc_gr002611

3.14 Ground Connection

See Graphic: *wc_gr002611*

A ground connection (**s**) is located next to the terminal lugs. The unit must have this ground lug connected to a good earthen ground for proper operating safety in compliance with NEC and local standards.

3.15 Convenience Receptacles

See Graphic: *wc_gr002611*

The generator is equipped with two 120V/240V twist lock receptacles (**l**) rated at 50A, and one 120V/240V twist lock receptacles (**m**) rated at 30A. The two 120V duplex receptacles (**n**) are equipped with ground fault interrupts (GFI). Receptacles **do not** connect through the main line circuit breaker. Each receptacle is protected by its own circuit breaker (**h, j, k**) which is located directly above it. Power to the receptacles is available any time the generator engine is running, even with the main line circuit breaker open.

Note: *When the voltage selector switch is in the 480 V / 3Ø position, voltage at the duplex receptacles is 139 V, and voltage at the 30/50 A receptacles is 139/240 V. When the voltage selector switch is in the 208 V / 3Ø position, voltage at the 30/50 A receptacles is 120/208 V. When the voltage selector switch is in the 208 V / 3Ø position, the voltage can be adjusted with the voltage adjustment rheostat (**f**) to 240 V / 3Ø. The voltage at the duplex receptacles is 139 V, and voltage at the 30/50 A receptacles is 139/240 V.*

3.16 Remote Run Terminal Block

See Graphic: *wc_gr002611*

The remote run terminal block (**o**) is located just to the right of the 120V duplex receptacles. It provides connection points for installation of a remote start switch. When it is connected to a transfer switch, it allows the generator to be used as a standby power supply.

3.17 Panel Door Interlock Switch

See Graphic: *wc_gr002611*

The customer connection lugs panel access door is equipped with an interlock switch (**q**). When the door is opened this switch automatically trips the main circuit breaker. Voltage to the receptacles will not be cut.

3.18 Terminal Connections

⚠ WARNING
 IMPROPER CONNECTION OF GENERATOR TO A BUILDING'S ELECTRICAL SYSTEM CAN ALLOW ELECTRICAL CURRENT FROM THE GENERATOR TO BACKFEED INTO UTILITY LINES. THIS MAY RESULT IN ELECTROCUTION OF UTILITY WORKERS, FIRE OR EXPLOSION. CONNECTIONS TO A BUILDING'S ELECTRICAL SYSTEM MUST BE MADE BY A QUALIFIED ELECTRICIAN AND COMPLY WITH ALL APPLICABLE LAWS AND ELECTRICAL CODES.

⚠ WARNING
 UNFACHGEMESSENER ANSCHLUSS DES STROMAGGREGATES AN DEN GEBÄUDE-STROMNETZANSCHLUSS KANN ZÜGEGENSTROM VOM AGGREGAT IN DAS STROMNETZ FÜHREN. DIES KÖNNTE ZU STROMSCHLAG, FEUER ODER EXPLOSION FÜHREN. ANSCHLUSS AN EIN GEBÄUDESTROMNETZ MUSS VON QUALIFIZIERTEM PERSONAL DURCHFÜHRT WERDEN UND MIT ALLEN ZUTREFFENDEN GESETZEN UND ELEKTRIZITÄTS-VORSCHRIFTEN ÜBEREINSTIMMEN.

⚠ ADVERTENCIA
 LA CONEXIÓN INCORRECTA DE UN GENERADOR AL SISTEMA ELÉCTRICO DE UN EDIFICIO PUEDE CONDUCIR A UN RETORNO DE LA CORRIENTE ELÉCTRICA DESDE EL GENERADOR AL SISTEMA DE DISTRIBUCIÓN ELÉCTRICO PÚBLICO. ESTO PUEDE CONDUCIR A LA ELECTROCUCIÓN DE LOS OBREROS DEL SERVICIO PÚBLICO, INCENDIOS O EXPLOSIONES. SOLO UN TÉCNICO ELECTRICISTA CAPACITADO PODRÁ EFECTUAR LA CONEXIÓN AL SISTEMA ELÉCTRICO DEL EDIFICIO. LA CONEXIÓN ELÉCTRICA DEBERÁ CUMPLIR CON LAS LEYES Y CÓDIGOS ELÉCTRICOS PERTINENTES.

⚠ AVERTISSEMENT
 LE BRANCHEMENT NON CONFORME DU GÉNÉRATEUR AU RÉSEAU DE DISTRIBUTION ÉLECTRIQUE IMMEUBLE PEUT PROVOQUER LA REINJECTION DU COURANT ÉLECTRIQUE DU GÉNÉRATEUR DANS LES LIGNES DU RÉSEAU PUBLIC. CECI PEUT PROVOQUER UNE ELECTROCUTION DES EMPLOYES DU SERVICE PUBLIC, UN INCENDIE OU UNE EXPLOSION. LES BRANCHEMENTS AU RÉSEAU ÉLECTRIQUE IMMEUBLE DOIVENT ÊTRE EFFECTUÉS PAR UN ÉLECTRICIEN QUALIFIÉ ET DOIVENT ÊTRE CONFORMES À TOUTES LES LOIS OU TOUTS LES CODÉS ÉLECTRIQUES APPLICABLES.

TERMINAL CONNECTIONS / VERBINDUNGSKLEMMEN
BORNES DE CONEXION / RACCORDS TERMINALS

L1-N = 277V
 L2-N = 277V
 L3-N = 277V
 L1-L2= 480V
 L2-L3= 480V
 L3-L1= 480V

L1-N = 120V
 L2-N = 120V
 L3-N = 120V
 L1-L2= 208V
 L2-L3= 208V
 L3-L1= 208V

L1-L3= 240V
 L1-N = 120V
 L2-N = 120V
 L3-N = 120V

ALL CONNECTIONS TO THE TERMINALS MUST BE MADE BY A TRAINED ELECTRICIAN.

BACKFEED FROM THE GENERATOR INTO THE UTILITY'S DISTRIBUTION SYSTEM CAN CAUSE A SERIOUS INJURY OR DEATH TO UTILITY WORKERS!

Improper connection of generator to a building's electrical system can allow electrical current from the generator to backfeed into utility lines. This may result in electrocution of utility workers, fire or explosion. Connections to a building's electrical system must be made by a qualified electrician and comply with all applicable laws and electrical codes.

DANGER OF ELECTROCUTION! ALWAYS OPEN MAIN CIRCUIT BREAKER AND SET ENGINE STOP SWITCH TO OFF "O" BEFORE INSPECTING OR ATTEMPTING ANY CONNECTIONS TO THE TERMINAL BLOCK! LETHAL VOLTAGE COULD BE PRESENT ON THE TERMINAL LUGS!

wc_tx000483gb.fm

36

3.19 Before Starting

Before putting the generator into service, review each item on the following checklist. Because generators are often run for long periods of time unattended, it is important to make sure that the unit is set up properly to reduce possible problems.



Failure to follow the procedures listed may cause injury to personnel or damage to the generator. Be certain that all persons setting up the generator are certified or fully trained on the installation of the generator.

- Check for any damage that might have been caused during shipping or towing.
- Check to make sure no debris has lodged in vents, near radiator or around fan. Check to make sure that the exhaust compartment is clean and nothing is touching the muffler or exhaust pipes.
- Check that generator is level.
- Chock trailer wheels.
- Check that generator is grounded to a good earthen ground per local regulations and NEC standards.
- Check engine oil, coolant and fuel levels, and fill as required.
- Determine voltage needs. Set voltage selector switch and make correct terminal connections.
- Check that all electrical connections were made in compliance with local regulations and NEC standards.
- Check fan belt and hoses on engine for loose connections or fraying. Tighten or replace as required.
- Close and secure side panel access doors.
- Review and follow safety instructions found in the front of this manual.

3.20 Manual Start-up

See Graphic: wc_gr001682, wc_gr001677, wc_gr002611

Before starting the generator set, thoroughly review the pre-start-up checklist in the previous section. Proceed with generator start-up only after checking each item in that section.

Thoroughly read and make sure you understand the engine Operator's Manual supplied with the generator. Follow the steps below and the illustration on the opposite page in the order listed.



When using the generator as a standby or substitute power supply, make sure the voltage and phase rotation of the line connections match those of the utility lines or of any other power source normally used. **Failure to match phase rotation and voltage may cause equipment connected to the generator to operate incorrectly! This could create unsafe operating conditions.**

- 3.20.1 Check position of Voltage Selector Switch and make sure it is set for the desired voltage output. Lock the switch in place.
- 3.20.2 Make sure the Engine Start Switch (**f**) is in the off "O" position.
- 3.20.3 Turn main line circuit breaker (**a**) and convenience receptacle circuit breakers to off "O". This will disconnect all loads from the generator.
- 3.20.4 Move Engine Start Switch (**f**) to "REMOTE START" to check operation of engine control module. The LCD panel should momentarily display "**SYSTEM OK**" followed by "**UNIT IN AUTO**" and engine information. Check fuel level and battery values.
Note: *The amber Warning Light (**d**) will come on if the fuel level is below 25%, or engine temperature is below 70°F. This will not prevent the engine from starting.*
- 3.20.5 Press in the Emergency Stop Button (**p**). The LCD panel should read "**EMERGENCY STOP**". Release the stop button after verifying the display and return the Engine Start Switch to off "O".
- 3.20.6 Start engine by moving the Engine Start Switch to the "START/RUN" position.

After displaying "**GLOW PLUG ON**" sequence, the LCD display will read "**STARTING ENGINE**" as the engine begins its crank cycle. The normal cycle is for the engine to crank for 15 seconds, then rest for 10 seconds. This cycle will repeat three (3) times. If the engine does not start within this time, the Engine Control Module will shut down the engine and "**FAULT OVERCRANK**" will be displayed on the LCD panel. To repeat crank cycle, return start switch to off "O" to reset Engine Control Module. Allow starter motor to cool between start-up attempts.

- 3.20.7 After engine starts, allow it to warm up for a few minutes and check readouts on LCD panel. The **“TIME TO SERVICE”** interval will be displayed. Make sure battery charging system, oil pressure and engine temperature readings are within normal ranges.
- 3.20.8 Check that AC voltage is correct. Voltage can be fine-adjusted by turning the voltage adjustment rheostat **(b)** on the metering panel.
- 3.20.9 Check frequency. Under no-load conditions, frequency should read around 61.5 Hz, dropping to near 60 Hz as the generator load is switched on.

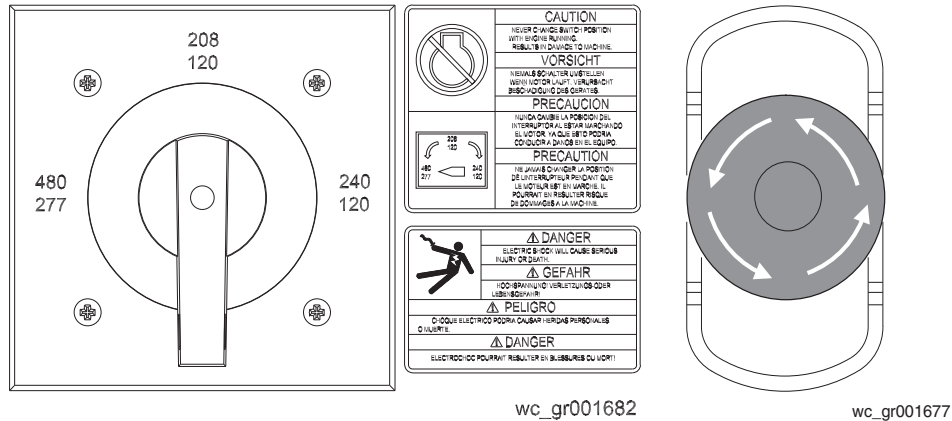

wc_gr001682

wc_gr001677

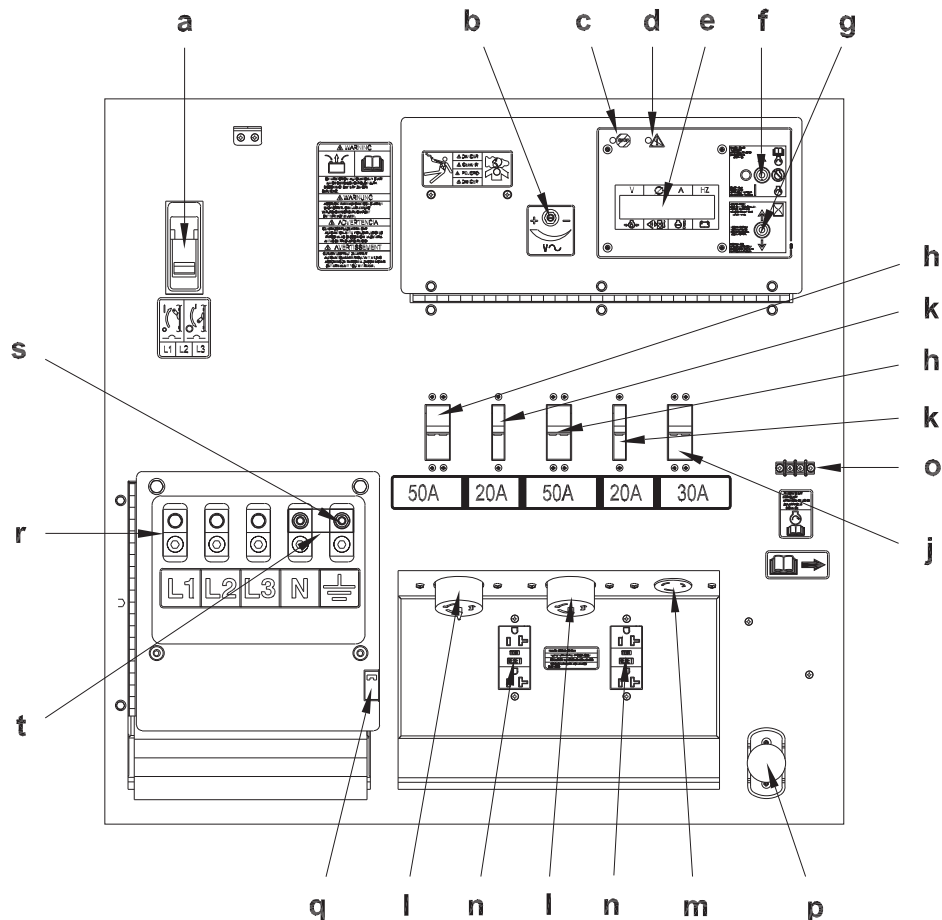

wc_gr002611

3.21 Running the Generator

See Graphic: wc_gr002611

Leave the Engine Start Switch (f) in the “START/RUN” position while the generator is operating. If the generator was started using a remote switch, leave Engine Start Switch in the “REMOTE START” position. Let the generator run for a few minutes to warm engine before closing main circuit breaker.



Before closing breakers, make sure that any electrical devices attached downstream from the generator will not start up unexpectedly.

While the generator is running, check for excessive vibration, oil leaks, or coolant leaks.



Before placing the Engine Start Switch (f) in the “REMOTE START” position, verify that the contacts on any remote switch linked to the generator set are OPEN. This will prevent the generator from immediately starting when the Engine Start Switch is moved to the “REMOTE START” position.

3.22 Engine Power Correction Factors

Performance data on John Deere engines are measured at the following standard conditions:

- 29.31 inches of mercury dry air pressure
- 600 feet altitude
- 0 % relative humidity
- 77°F air intake temperature
- 104°F fuel inlet temperature

Refer to the table to estimate the engine power decrease in percent, as environmental factors vary from the standard conditions.

MODEL	FUEL TEMP RISE of 1.8°F	AIR TEMP RISE of 10°F	ALTITUDE RISE of 305 m (1000 ft)	RELATIVE HUMIDITY RISE of 10%
G 50	0.17	1.50	3.00	0.10
G 70 G 85	0.19	0.50	see chart below	0.07

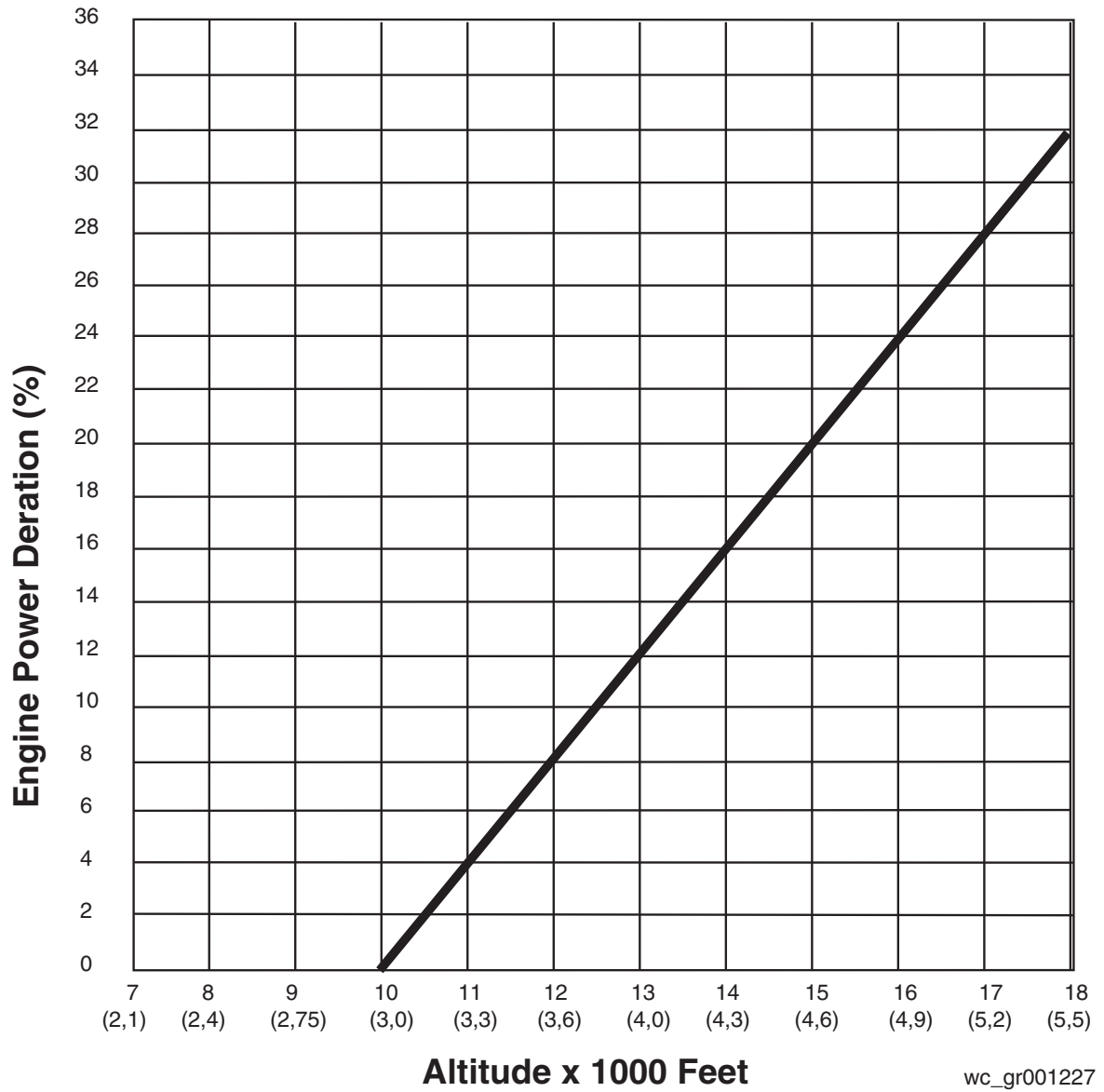

3.23 Shutting Down Generator

Check with other personnel on the jobsite and let them know that power is being turned off. Make sure that the power shutdown will not create any hazards by turning off devices such as pumps, heaters, or lights that may need to be kept on.

- 3.23.1 Remove all loads from generator.
- 3.23.2 Open (turn to off “O”) main line circuit breaker.
- 3.23.3 Let engine run for approximately 5 minutes to allow it to cool down.
- 3.23.4 Move Engine Start Switch to the off “O” position.

3.24 Cold Weather Start-up

Good cold-weather starting requires that the battery be at peak power, the correct weight motor oil is used, and the starter motor is in good condition. The ECM will automatically activate the cold starting aid when the temperature is low enough and will display “AIR INTAKE HEATER” during the time the cold starting aid is activated.

3.25 Lifting

A central lifting eye is located at the top of the generator and is attached to a lifting frame inside the housing.

Refer to the Technical Data for the proper operating weight of the generator. Make sure the lifting devices have sufficient capacity to lift the unit safely.

When lifting the generator, attach a hook or sling securely to the lifting eye.

3.26 Overnight Storage

When storing unit overnight, make sure all access doors are closed and padlocked.

DO NOT store generator overnight in a low lying area that might fill with water during a heavy storm.

3.27 Long-term Storage

If the generator is being stored for several months, follow the engine manufacturer’s recommendations for long-term storage. These procedures are designed to help minimize engine corrosion.

3.28 Automatic/Remote Start-up

See Graphic: *wc_gr002611*

In the “REMOTE START” position the generator can be started remotely, either through a transfer switch or some other type of remote start switch. “REMOTE START” is the normal setting when using the generator as a standby power supply. Before placing the generator in the automatic start-up mode, review the pre-start and manual Start-up sections in this manual and follow procedure below.



Before placing the Engine Start Switch (f) in the “REMOTE START” position, verify that the contacts on any remote switch linked to the generator set are OPEN. This will prevent the generator from immediately starting when the Engine Start Switch is moved to the “REMOTE START” position.

- 3.28.1 Perform a manual start at least once to verify that the metering panel is operating correctly. Refer to Section *Before Starting* and *Manual Start-up* sections in this manual.
- 3.28.2 If a check of auto start-up circuit is desired, attach a short jumper wire (minimum 16 gauge insulated) between the two terminals on the remote run terminal block. This applies a ground to the Engine Control Module to complete the start circuit. The engine should crank, start and run.

Move the Engine Start Switch to off “O” to stop engine. Remove jumper from remote run terminals after testing is complete.
- 3.28.3 Secure generator by closing and locking all doors.
- 3.28.4 Set Engine Start Switch to “REMOTE START” and close main line circuit breaker.

The generator is now ready for automatic start-up.

If the generator is to be used as a stand-by power supply for more than a month, provisions must be made to maintain battery charge. This can be done either by attaching a battery charger to the battery or by starting generator manually and running engine periodically to maintain charge. See Section *Manual Start-up*.

3.29 Remote/Transfer Switch

See Graphic: wc_gr002611



DANGER

When the generator is used as a standby power supply, it must be equipped with a device which isolates it from the utility's distribution system.

Failure to isolate the generator from the utility's electrical distribution system could cause output from the generator to backfeed into the utility lines and cause injury or death to utility workers!

The same is true if using the generator as a backup to some other type of power supply system.

A transfer switch is designed to transfer electrical loads from the normal power source (utility) to the emergency power source (generator) when normal voltage falls below a prescribed level.

The transfer switch automatically returns the load back to the normal source when power is restored back to operating levels.

Installation of a transfer switch or other type of remote starting device is the responsibility of the generator user. Installation of such devices must be performed by a qualified electrician following all directions supplied by the manufacturer of the switch. If attaching generator to a power supply normally serviced by a utility company, notify the utility company and check local and state regulations. Familiarize yourself with all instructions and warning labels supplied with the switch.

The bond bar (**t**), connecting the neutral and ground lugs, may need to be removed for standby power applications. Check with NEC and local regulations for compliance requirements.



WARNING

When using the generator as a standby or substitute power supply, make sure the voltage and phase rotation of the line connections match those of the utility lines, or of any other power source normally used. **Failure to match phase rotation and voltage may cause equipment connected to the generator to operate incorrectly! This could create unsafe operating conditions.**



DANGER

Lethal voltage is always present in the transfer switch once it has been properly installed!

3.30 Towing

See Graphic: *wc_gr000510*

The generator trailer is equipped with brakes, lights, and coupler connection. Before towing the generator, perform the following:

- 3.30.1 Check that the towing vehicle and hitch have a rating equal to or greater than the GVWR. Refer to the Technical Data.
- 3.30.2 Check the condition of both the coupler and hitch. **DO NOT** tow the trailer if the coupler or hitch is damaged.
- 3.30.3 Make sure that the hitch and coupler are compatible. The generator trailer is equipped with either a pintle type coupler **(a)** or 50 mm (2 in.) ball coupler.
- 3.30.4 Check that the directional and running lights on the trailer are working.
- 3.30.5 Connect the safety chains **(c)** using a crossed pattern under the trailer tongue.
- 3.30.6 On trailers with surge or electric brakes, connect the breakaway cable **(b)** on the trailer coupler to the rear bumper or frame of the vehicle. This cable will actuate the brake system on the trailer if both the coupling and safety chains have failed. The breakaway cable is not a parking brake and should not be used as one.
- 3.30.7 Check that all fasteners on the coupling are secure.
- 3.30.8 Check the tread wear and inflation on tires. Make sure that all lug nuts are in place and are tight.
- 3.30.9 Check the operation of the optional surge brakes by braking the vehicle at a slow speed before entering traffic. Both the vehicle and the trailer should brake smoothly. If the trailer seems to be pushing, check the fluid level **(d)** in the surge brakes or the operation of the electric brakes.

A film of grease on the coupler will extend coupler and ball life and eliminate squeaking. Wipe the coupler and ball clean and apply fresh grease each time the trailer is towed.

NOTICE: When towing, maintain extra space between vehicles and avoid soft shoulders, curbs and sudden lane changes. If you have not pulled a trailer before, practice turning, stopping, and backing up in an area away from heavy traffic.

DO NOT exceed 55 mph when towing a trailer.

In most states, large trailers must be registered and licensed by the State Department of Transportation. Before towing, be sure to check licensing requirements.

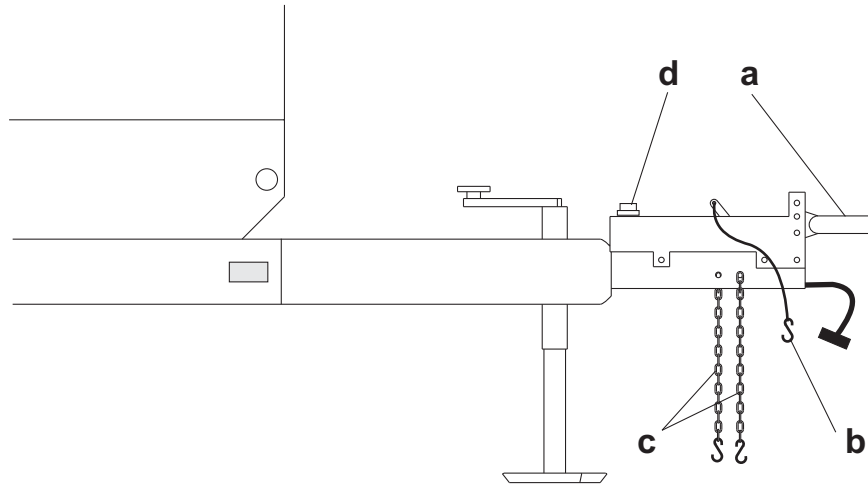

wc_gr000510

4. Maintenance

4.1 Periodic Maintenance Schedule

The Periodic Maintenance Schedule below lists basic maintenance intervals for the engine and generator. For detailed maintenance procedures on the engine, refer to the engine Operator's Manual.

	Daily	50 Hrs or 2 weeks	250 Hrs	600 Hrs or 12 Mo	1200 Hrs or 24 Mo	2000 Hrs	Other
Check engine oil and coolant level	■						
Check engine air filter gauge & air cleaner dust cap *	■						
Visual walkaround inspection	■						
Check tire inflation, tread wear and lug nuts before towing	■						
Check fuel filter		■					
Drain containment system		■					
Service the battery			■				
Change engine oil and replace oil filter**			■				
Clean unit inside and out			■				
Check air intake hoses, connections, and system				■			
Replace fuel filter element				■			
Check automatic belt tensioner and belt wear				■			
Check cooling system				■			
Perform coolant solution analysis & add SCA's				■			
Grease axle				■			
Pressure test cooling system					■		
Flush cooling system***					■		
Check and adjust engine valve clearance						■	
Check brake fluid level in trailer at least monthly							■
Replace crankcase ventilation filter every 750 hours							■

*Replace the air filter cartridge when yellow indicator of the engine air filter gauge reaches the red line.

**Change the oil after the first 100 hours, then every 250 hours.

***If John Deere antifreeze is used, the flushing interval may be extended. See engine Operator's Manual.

4.2 New Machines

- 4.2.1 Run generator at least 60–100% of continuous load for the first 100 hours.
- 4.2.2 Change engine oil and replace oil filter after the first 50 hours.

4.3 Resetting the Periodic Maintenance Timer

After maintenance has been performed on the generator, it is necessary to reset the periodic maintenance timer.

- If the periodic maintenance timer is at zero, press the ENG. HRS switch UP and hold for 10 seconds until the “TIME TO SERVICE” resets to 250 hours.
- If the service time is greater than zero (maintenance was performed prior to the timer running out) press and hold the ENG. HRS switch UP and hold for 30 seconds. This will reset the “TIME TO SERVICE” to 250 hours.

4.4 Air Cleaner

See Graphic: *wc_gr000511*

Replace the air filter cartridge when yellow indicator of the engine air filter gauge reaches the red line.

The air cleaner assembly contains a one-piece single element air filter cartridge **(c)**.

To replace the air filter cartridge:

- Remove the end cover **(d)**, then discard the entire air filter cartridge.
- Insert a new air filter cartridge, then
- Re-install the end cover, making sure that the dust cap **(e)** is clean and is pointing downward.

Periodically, make sure the inlet pipe **(f)** is free from obstructions.

Check all connections and make sure they are snug. An air leak at the neck clamp, gauge connection, or intake pipe can quickly lead to expensive engine repairs.

- Make sure that the intake piping **(a)** is fully engaged over the neck of the filter to ensure a good seal.
- If the filter housing, gauge connection **(b)**, neck, or inlet pipe are crushed or damaged, replace them immediately.

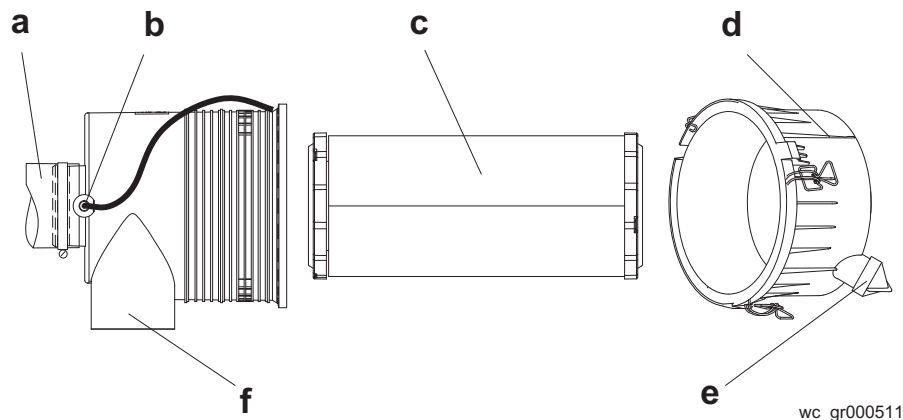

wc_gr000511

4.5 Engine Lubrication

Check engine oil daily before starting engine.

DO NOT operate engine if oil level is below ADD mark on dipstick. Always keep oil level within the crosshatch pattern or “full” mark on dipstick.

Change oil after first 100 hours of operation and every 250 hours thereafter. Refer to the engine manufacturer’s Operator’s Manual for lubrication specifications.

Break-in Service

4.5.1 This engine is factory-filled with John Deere Engine Break-in Oil. Operate the engine at heavy loads with minimal idling during the break-in period. **DO NOT** exceed 100 hours of operation with break-in oil.

4.5.2 If the engine has significant operating time at light load, or makeup oil is required in the first 100 hour period, a longer break-in period may be required. In these situations, an additional 100 hour break-in period is recommended using a new change of John Deere Engine Break-In Oil and a new John Deere oil filter.

NOTICE: DO NOT add makeup oil until the oil level is **BELOW** the ADD mark on dipstick. John Deere Engine Break-In Oil (TY22041) should be used to make up any oil consumed during the break-in period.

4.5.3 During the first 20 hours, avoid prolonged periods of no load or sustained maximum load operation. If engine is to run for longer than 5 minutes without a load, shut unit down.

4.5.4 After the first 100 hours, change engine oil and replace engine oil filter. Fill crankcase with seasonal viscosity grade oil.

4.6 Engine Coolant

Check the coolant level of the radiator with the engine cold. After initial filling of radiator to 3/4" below bottom of filler neck, maintain proper level in overflow bottle daily.



WARNING

NEVER remove radiator cap or drain plug while engine is hot! Pressurized coolant can cause serious burns.

Shut off engine. Only remove radiator cap when it is cool enough to touch with bare hands. Slowly loosen cap to relieve pressure first, before removing it completely.

Solutions of antifreeze and supplemental coolant additives **MUST** be used year-round. Automotive-type coolants do not contain the correct coolant additives to protect heavy-duty diesel engines. They often contain a high concentration of silicates which can damage the engine and cooling system. Refer to engine Operator's Manual for coolant recommendations.

4.7 Trailer Maintenance

Tires - Keep tires inflated to the proper pressure as shown on the tire sidewall, and check tread periodically for wear. Replace tires as required.

Wheels - Check that lug nuts holding wheels are tight. Replace any missing nuts immediately.

Axle Hubs - Grease axle hubs through grease fittings using a good wheel bearing grease.

Brakes - Check operation of brakes before each trip.

Check level of brake fluid in actuator at front of trailer at regular intervals. Fill to approximately 1" below top of reservoir using DOT-3 heavy-duty brake fluid. Tighten filler plug securely.

Note: *If fluid level has fallen too low, bleed brake lines to remove any air trapped in lines.*

4.8 Troubleshooting Automatic Shutdown

There are several automatic shutdown conditions: low oil pressure, high coolant temperature, engine overspeed, engine underspeed, engine overcrank, and low fuel. When these occur, the operator can perform certain diagnostic tests to help identify the problem. Most of these diagnostics deal with the engine.

The generator, however, can also cause problems. Consult a qualified electrician or your nearest WACKER Dealer for possible causes of generator problems. For SPN.FMI Diagnostic Codes, contact WACKER or John Deere service departments.



Anytime the generator is down for service, secure it by closing and locking all doors, and hang a "DO NOT RUN" sign on the metering panel.

Low Oil Pressure Shutdown

- 4.8.1 Check engine oil level using dipstick. Add oil if required.
- 4.8.2 Carefully inspect engine for oil leaks.
- 4.8.3 If oil level is good, start engine and verify loss of oil pressure. Shut down engine immediately if oil pressure value does not read at least 15 psi within 5 seconds.

Check the oil pressure shutdown sender and connecting wiring on the engine block. Check for Diagnostic Trouble Codes.

- 4.8.4 If oil level, oil pressure sender and connecting wiring are good, the fault could be caused by an engine failure.

High Coolant Temperature Shutdown

- 4.8.1 Restart engine and read water temperature. Stop engine if temperature is above 226°F. Normal engine operating temperature is between 170°-190° F.
- 4.8.2 Allow engine to cool to a safe temperature and inspect coolant level in radiator. Add coolant as needed.
- 4.8.3 Carefully inspect coolant hoses and engine block for leaks.
- 4.8.4 Check that fan belt for water pump is tight.
- 4.8.5 Check the high temperature shutdown sender and connecting wiring on engine block. Check for Diagnostic Trouble Codes.
- 4.8.6 If sender and wiring are good, consult engine manufacturer's Operator's Manual or Service Manual for possible causes of engine overheating.

Overspeed or Underspeed Shutdown

Restart engine and read the AC frequency meter. Meter should read 60 Hz under no-load condition.

Overcrank Shutdown

- 4.8.1 Check fuel level.
- 4.8.2 Check for proper operation of fuel pump.
- 4.8.3 If engine still does not start, refer to engine manufacturer's Operator's Manual or Service Manual for possible engine problems.

Low Fuel Level Shutdown

- 4.8.1 Check fuel level.
Note: *Warning light will come on when fuel level drops below 25%. Engine will shut down only when level drops below 5%.*
- 4.8.2 Check for leaks in fuel tank.
- 4.8.3 Check for Diagnostic Trouble Codes.
- 4.8.4 If fuel level is good, check fuel level sender and connecting wiring on engine. Check for continuity between sender on tank and engine control module. See wiring diagrams.

4.9 Wire Colors

Wire Colors							
B	Black	R	Red	Y	Yellow	Or	Orange
G	Green	T	Tan	Br	Brown	Pr	Purple
L	Blue	V	Violet	Cl	Clear	Sh	Shield
P	Pink	W	White	Gr	Gray	LL	Light blue

4.10 Generator and Receptacle Wiring

BOM	Revision	See Graphic:	Revision	See Graphic:	Revision	See Graphic:
0009366	123 & higher	wc_gr004692	106-122	wc_gr003171	105 & lower	wc_gr002614
0009367	124 & higher	wc_gr004692	106-123	wc_gr003171	105 & lower	wc_gr002614
0009369	124 & higher	wc_gr004692	106-123	wc_gr003171	105 & lower	wc_gr002614
0009467	131 & higher	wc_gr004692	107-130	wc_gr003171	106 & lower	wc_gr002614
0009468	133 & higher	wc_gr004692	107-132	wc_gr003171	106 & lower	wc_gr002614
0009459	133 & higher	wc_gr004692	107-132	wc_gr003171	106 & lower	wc_gr002614
0620001	127 & higher	wc_gr004692	106-126	wc_gr003171	105 & lower	wc_gr002614
0620002	129 & higher	wc_gr004692	106-128	wc_gr003171	105 & lower	wc_gr002614
0620003	129 & higher	wc_gr004692	107-128	wc_gr003171	106 & lower	wc_gr002614
0620350		wc_gr004692				
0620351		wc_gr004692				
0620352		wc_gr004692				

Ref.	Description	Ref.	Description
1	Lug safety limit switch	15	Voltage selector switch
2	Mechanical lugs	16	Generator
3	Plug 3 - current transformer inputs	17	Voltage regulator
4	Plug 4 - line voltage inputs	18	Voltage adjustment rheostat
5	Shunt	19	Terminal Block
6	120V 20A GFI receptacle	20	Exciter
7	120V breaker	21	Stator
8	240V 50A breaker	22	Rotor
9	240V 30A breaker	23	Rectifier
10	240V 50A receptacle	24	Rotor winding
11	240V 30A receptacle	25	Main stator windings
12	Engine control module	26	Auxiliary Stator Winding
13	Main breaker	27	Stator
14	Bond bar	28	Terminal Strip

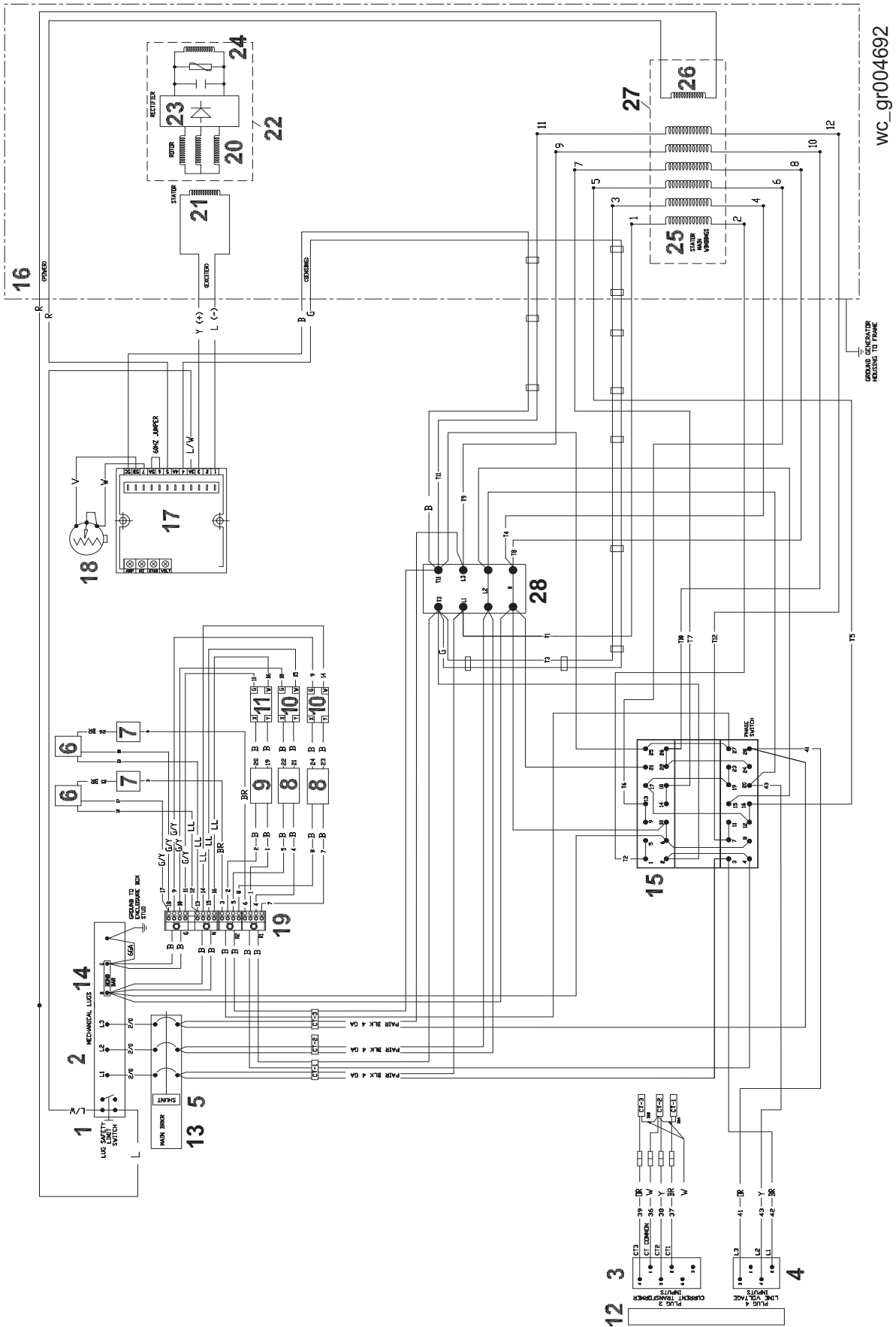

wc_gr004692

GROUND GENERATOR HOUSING TO FRAME

BOM	Revision	See Graphic:	Revision	See Graphic:	Revision	See Graphic:
0009366	123 & higher	wc_gr004692	106-122	wc_gr003171	105 & lower	wc_gr002614
0009367	124 & higher	wc_gr004692	106-123	wc_gr003171	105 & lower	wc_gr002614
0009369	124 & higher	wc_gr004692	106-123	wc_gr003171	105 & lower	wc_gr002614
0009467	131 & higher	wc_gr004692	107-130	wc_gr003171	106 & lower	wc_gr002614
0009468	133 & higher	wc_gr004692	107-132	wc_gr003171	106 & lower	wc_gr002614
0009459	133 & higher	wc_gr004692	107-132	wc_gr003171	106 & lower	wc_gr002614
0620001	127 & higher	wc_gr004692	106-126	wc_gr003171	105 & lower	wc_gr002614
0620002	129 & higher	wc_gr004692	106-128	wc_gr003171	105 & lower	wc_gr002614
0620003	129 & higher	wc_gr004692	107-128	wc_gr003171	106 & lower	wc_gr002614
0620350		wc_gr004692				
0620351		wc_gr004692				
0620352		wc_gr004692				

Ref.	Description	Ref.	Description
1	Lug safety limit switch	15	Voltage selector switch
2	Mechanical lugs	16	Generator
3	Plug 3 - current transformer inputs	17	Voltage regulator
4	Plug 4 - line voltage inputs	18	Voltage adjustment rheostat
5	Shunt	19	Terminal Block
6	120V 20A GFI receptacle	20	Exciter
7	120V breaker	21	Stator
8	240V 50A breaker	22	Rotor
9	240V 30A breaker	23	Rectifier
10	240V 50A receptacle	24	Rotor winding
11	240V 30A receptacle	25	Main stator windings
12	Engine control module	26	Auxiliary Stator Winding
13	Main breaker	27	Stator
14	Bond bar	28	Terminal Strip

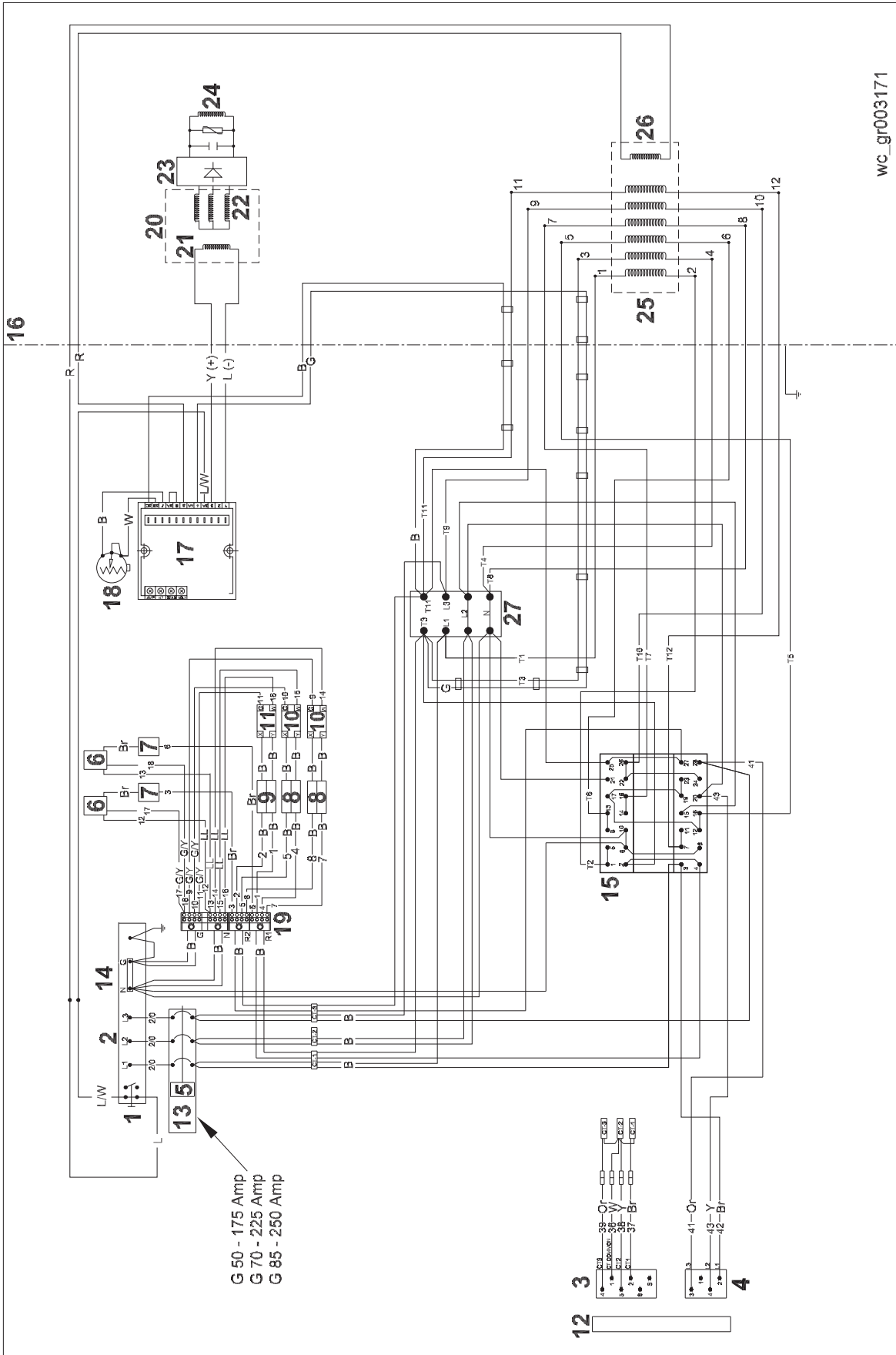

wc_gr003171

BOM	Revision	See Graphic:	Revision	See Graphic:	Revision	See Graphic:
0009366	123 & higher	wc_gr004692	106-122	wc_gr003171	105 & lower	wc_gr002614
0009367	124 & higher	wc_gr004692	106-123	wc_gr003171	105 & lower	wc_gr002614
0009369	124 & higher	wc_gr004692	106-123	wc_gr003171	105 & lower	wc_gr002614
0009467	131 & higher	wc_gr004692	107-130	wc_gr003171	106 & lower	wc_gr002614
0009468	133 & higher	wc_gr004692	107-132	wc_gr003171	106 & lower	wc_gr002614
0009459	133 & higher	wc_gr004692	107-132	wc_gr003171	106 & lower	wc_gr002614
0620001	127 & higher	wc_gr004692	106-126	wc_gr003171	105 & lower	wc_gr002614
0620002	129 & higher	wc_gr004692	106-128	wc_gr003171	105 & lower	wc_gr002614
0620003	129 & higher	wc_gr004692	107-128	wc_gr003171	106 & lower	wc_gr002614
0620350		wc_gr004692				
0620351		wc_gr004692				
0620352		wc_gr004692				

Ref.	Description	Ref.	Description
1	Lug safety limit switch	15	Voltage selector switch
2	Mechanical lugs	16	Generator
3	Plug 3 - current transformer inputs	17	Voltage regulator
4	Plug 4 - line voltage inputs	18	Voltage adjustment rheostat
5	Shunt	19	Terminal Block
6	120V 20A GFI receptacle	20	Exciter
7	120V breaker	21	Stator
8	240V 50A breaker	22	Rotor
9	240V 30A breaker	23	Rectifier
10	240V 50A receptacle	24	Rotor winding
11	240V 30A receptacle	25	Main stator windings
12	Engine control module	26	Auxiliary Stator Winding
13	Main breaker	27	Stator
14	Bond bar	28	Terminal Strip

4.11 Trailer Wiring

Ref.	Description
1	Front right side amber light
2	Front left side amber light
3	Trailer plug
4	Battery
5	Brake solenoid
6	Right rear taillight
7	License plate holder lights
8	Left rear taillight
9	Rear right side red light
10	Rear left side red light

Ref.	Wire Colors	Rear Lights	Side Lights	Harness
B	BLACK	Ground	Ground	Battery charge
Br	BROWN	Taillight		Tail, side and license plate
L	BLUE			
R	RED	Brake light	Power	Electric brakes
Y	YELLOW			Left brake light and directional
G	GREEN			Right brake light and directional
W	WHITE			Ground

Standard and Hydraulic Brakes

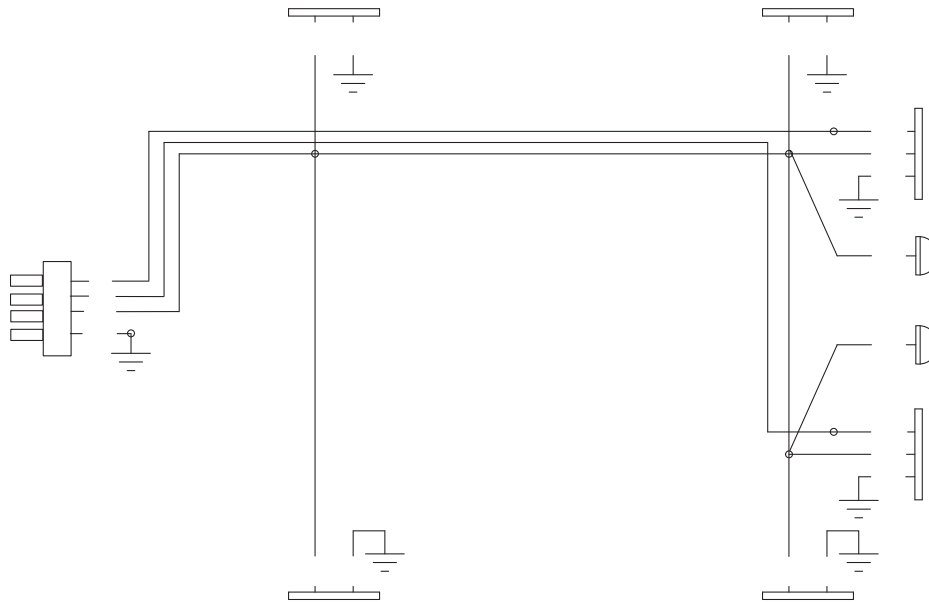

Electric Brakes

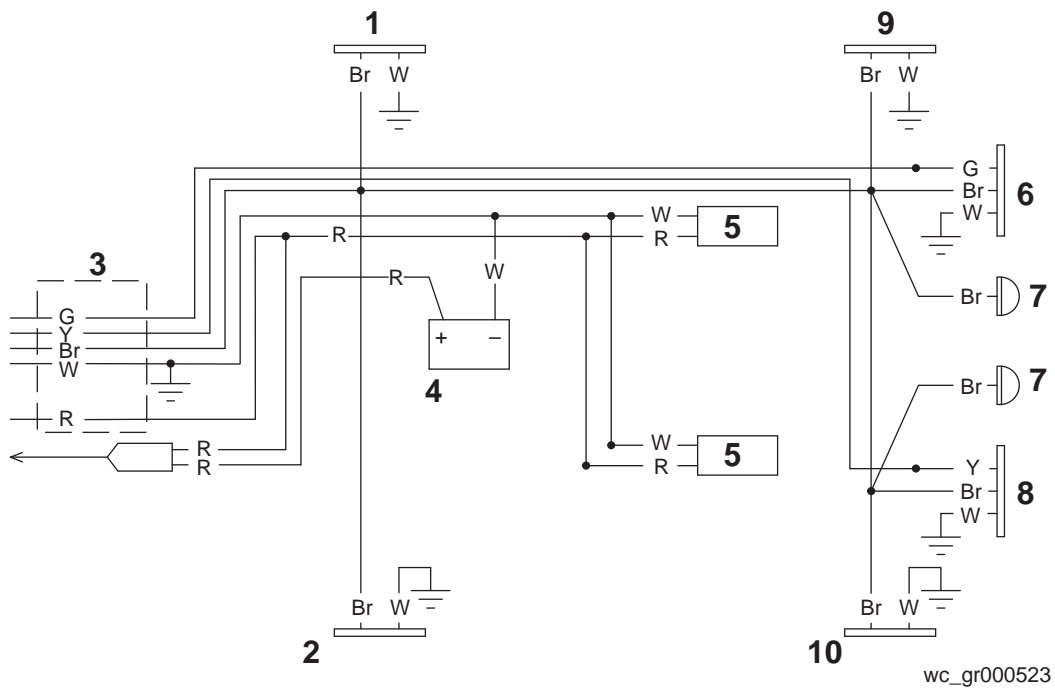

wc_gr000523

4.12 G 50/G 70 Engine Wiring

BOM	Revision	See Graphic:	Revision	See Graphic:	Rev.	See Graphic:	Revision	See Graphic:
0009366	123 & higher	wc_gr004613	109-122	wc_gr003218	108	wc_gr003172	107 & lower	wc_gr002615
0009367	124 & higher	wc_gr004613	110-123	wc_gr003218	109	wc_gr003172	108 & lower	wc_gr002615
0009467	131 & higher	wc_gr004613	112-130	wc_gr003218	111	wc_gr003172	110 & lower	wc_gr002615
0009468	133 & higher	wc_gr004613	114-132	wc_gr003218	113	wc_gr003172	112 & lower	wc_gr002615
0620001	127 & higher	wc_gr004613	109-126	wc_gr003218	108	wc_gr003172	107 & lower	wc_gr002615
0620002	129 & higher	wc_gr004613	110-128	wc_gr003218	109	wc_gr003172	108 & lower	wc_gr002615

Engine

Ref.	Description	Ref.	Description
1	Safety interlock switch	12	Plug 2 - engine start outputs
2	Mechanical lugs	13	Run/off/auto switch
3	Main circuit breaker	14	Battery
4	Shunt	15	10A fuse
5	Emergency stop switch	16	Starter relay
6	Engine control module	17	Starter
7	Plug 1 - engine sender inputs	18	Alternator
8	Remote start contacts	19	Terminal block
9	Fuel level sender	20	Magnetic pickup
10	Intake heater	21	Oil pressure sender
11	Intake heater relay	22	Water temperature sender

Wires

Ref.	Description	Ref.	Description
17	Battery +	61	E-Stop
18	Battery +	62	Fuel level
53	Battery +	63	Crank
54	Speed sensor	64	Run/Fuel
56	Cold crank delay	65	Preheat
57	Water temperature	73	Remote annunciator
59	Battery -	75	Remote annunciator
60	Remote start	87	Oil pressure

G 50/G 70 Engine Wiring

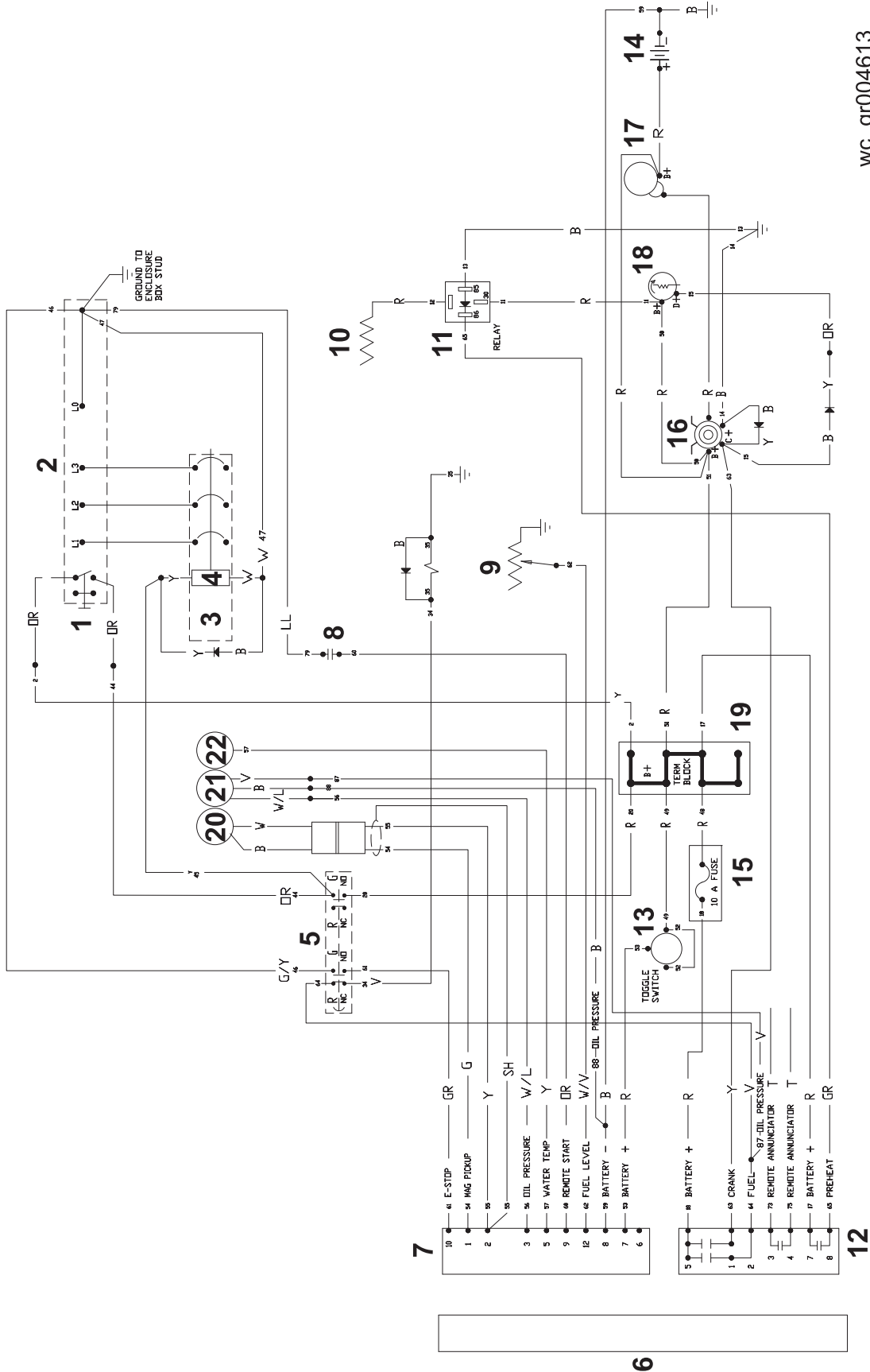

wc_gr004613

BOM	Revision	See Graphic:	Revision	See Graphic:	Rev.	See Graphic:	Revision	See Graphic:
0009366	123 & higher	wc_gr004613	109-122	wc_gr003218	108	wc_gr003172	107 & lower	wc_gr002615
0009367	124 & higher	wc_gr004613	110-123	wc_gr003218	109	wc_gr003172	108 & lower	wc_gr002615
0009467	131 & higher	wc_gr004613	112-130	wc_gr003218	111	wc_gr003172	110 & lower	wc_gr002615
0009468	133 & higher	wc_gr004613	114-132	wc_gr003218	113	wc_gr003172	112 & lower	wc_gr002615
0620001	127 & higher	wc_gr004613	109-126	wc_gr003218	108	wc_gr003172	107 & lower	wc_gr002615
0620002	129 & higher	wc_gr004613	110-128	wc_gr003218	109	wc_gr003172	108 & lower	wc_gr002615

Engine

Ref.	Description	Ref.	Description
1	Safety interlock switch	12	Plug 2 - engine start outputs
2	Mechanical lugs	13	Run/off/auto switch
3	Main circuit breaker	14	Battery
4	Shunt	15	10A fuse
5	Emergency stop switch	16	Starter relay
6	Engine control module	17	Starter
7	Plug 1 - engine sender inputs	18	Alternator
8	Remote start contacts	19	Terminal block
9	Fuel level sender	20	Magnetic pickup
10	Intake heater	21	Oil pressure sender
11	Intake heater relay	22	Water temperature sender

Wires

Ref.	Description	Ref.	Description
17	Battery +	61	E-Stop
18	Battery +	62	Fuel level
53	Battery +	63	Crank
54	Speed sensor	64	Run/Fuel
56	Cold crank delay	65	Preheat
57	Water temperature	73	Remote annunciator
59	Battery -	75	Remote annunciator
60	Remote start	87	Oil pressure

G 50/G 70 Engine Wiring

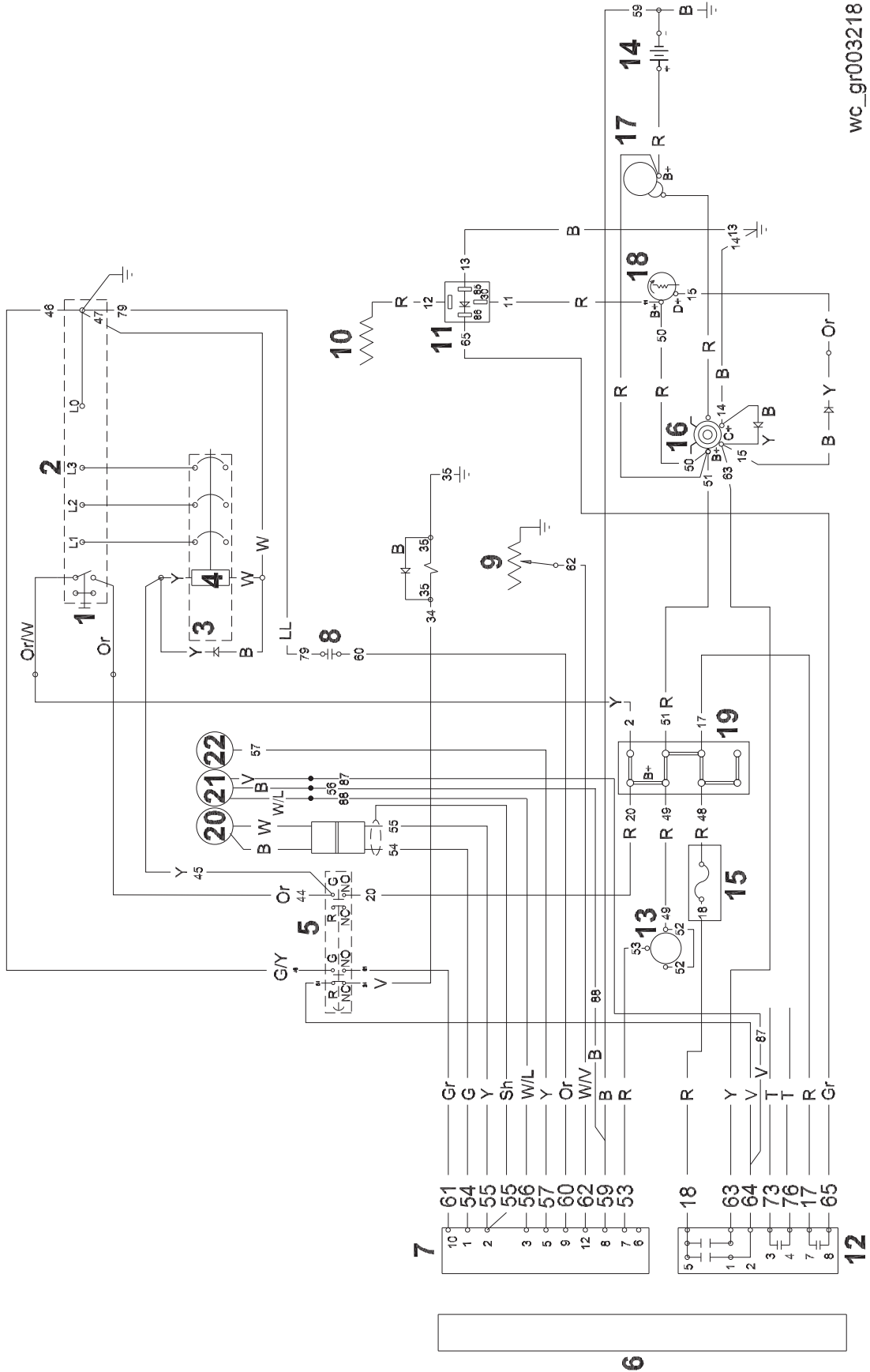

wc_gr003218

BOM	Revision	See Graphic:	Revision	See Graphic:	Rev.	See Graphic:	Revision	See Graphic:
0009366	123 & higher	wc_gr004613	109-122	wc_gr003218	108	wc_gr003172	107 & lower	wc_gr002615
0009367	124 & higher	wc_gr004613	110-123	wc_gr003218	109	wc_gr003172	108 & lower	wc_gr002615
0009467	131 & higher	wc_gr004613	112-130	wc_gr003218	111	wc_gr003172	110 & lower	wc_gr002615
0009468	133 & higher	wc_gr004613	114-132	wc_gr003218	113	wc_gr003172	112 & lower	wc_gr002615
0620001	127 & higher	wc_gr004613	109-126	wc_gr003218	108	wc_gr003172	107 & lower	wc_gr002615
0620002	129 & higher	wc_gr004613	110-128	wc_gr003218	109	wc_gr003172	108 & lower	wc_gr002615

Engine

Ref.	Description	Ref.	Description
1	Safety interlock switch	12	Plug 2 - engine start outputs
2	Mechanical lugs	13	Run/off/auto switch
3	Main circuit breaker	14	Battery
4	Shunt	15	10A fuse
5	Emergency stop switch	16	Starter relay
6	Engine control module	17	Starter
7	Plug 1 - engine sender inputs	18	Alternator
8	Remote start contacts	19	Terminal block
9	Fuel level sender	20	Magnetic pickup
10	Intake heater	21	Oil pressure sender
11	Intake heater relay	22	Water temperature sender

Wires

Ref.	Description	Ref.	Description
17	Battery +	61	E-Stop
18	Battery +	62	Fuel level
53	Battery +	63	Crank
54	Speed sensor	64	Run/Fuel
56	Cold crank delay	65	Preheat
57	Water temperature	73	Remote annunciator
59	Battery -	75	Remote annunciator
60	Remote start	87	Oil pressure

G 50/G 70 Engine Wiring

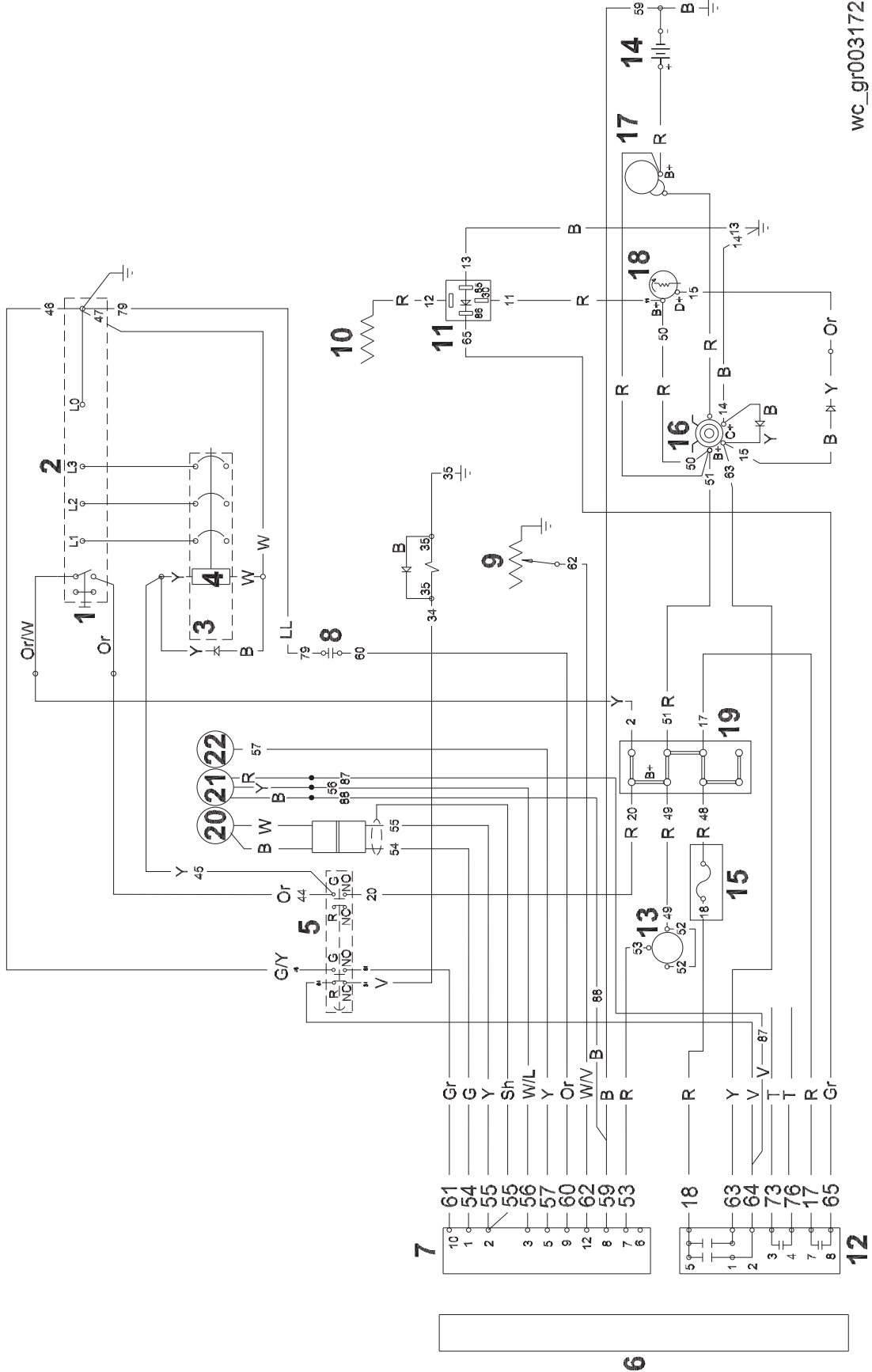

WC_gr003172

BOM	Revision	See Graphic:	Revision	See Graphic:	Rev.	See Graphic:	Revision	See Graphic:
0009366	123 & higher	wc_gr004613	109-122	wc_gr003218	108	wc_gr003172	107 & lower	wc_gr002615
0009367	124 & higher	wc_gr004613	110-123	wc_gr003218	109	wc_gr003172	108 & lower	wc_gr002615
0009467	131 & higher	wc_gr004613	112-130	wc_gr003218	111	wc_gr003172	110 & lower	wc_gr002615
0009468	133 & higher	wc_gr004613	114-132	wc_gr003218	113	wc_gr003172	112 & lower	wc_gr002615
0620001	127 & higher	wc_gr004613	109-126	wc_gr003218	108	wc_gr003172	107 & lower	wc_gr002615
0620002	129 & higher	wc_gr004613	110-128	wc_gr003218	109	wc_gr003172	108 & lower	wc_gr002615

Engine

Ref.	Description	Ref.	Description
1	Safety interlock switch	12	Plug 2 - engine start outputs
2	Mechanical lugs	13	Run/off/auto switch
3	Main circuit breaker	14	Battery
4	Shunt	15	10A fuse
5	Emergency stop switch	16	Starter relay
6	Engine control module	17	Starter
7	Plug 1 - engine sender inputs	18	Alternator
8	Remote start contacts	19	Terminal block
9	Fuel level sender	20	Magnetic pickup
10	Intake heater	21	Oil pressure sender
11	Intake heater relay	22	Water temperature sender

Wires

Ref.	Description	Ref.	Description
17	Battery +	61	E-Stop
18	Battery +	62	Fuel level
53	Battery +	63	Crank
54	Speed sensor	64	Run/Fuel
56	Cold crank delay	65	Preheat
57	Water temperature	73	Remote annunciator
59	Battery -	75	Remote annunciator
60	Remote start	87	Oil pressure

G 50/G 70 Engine Wiring

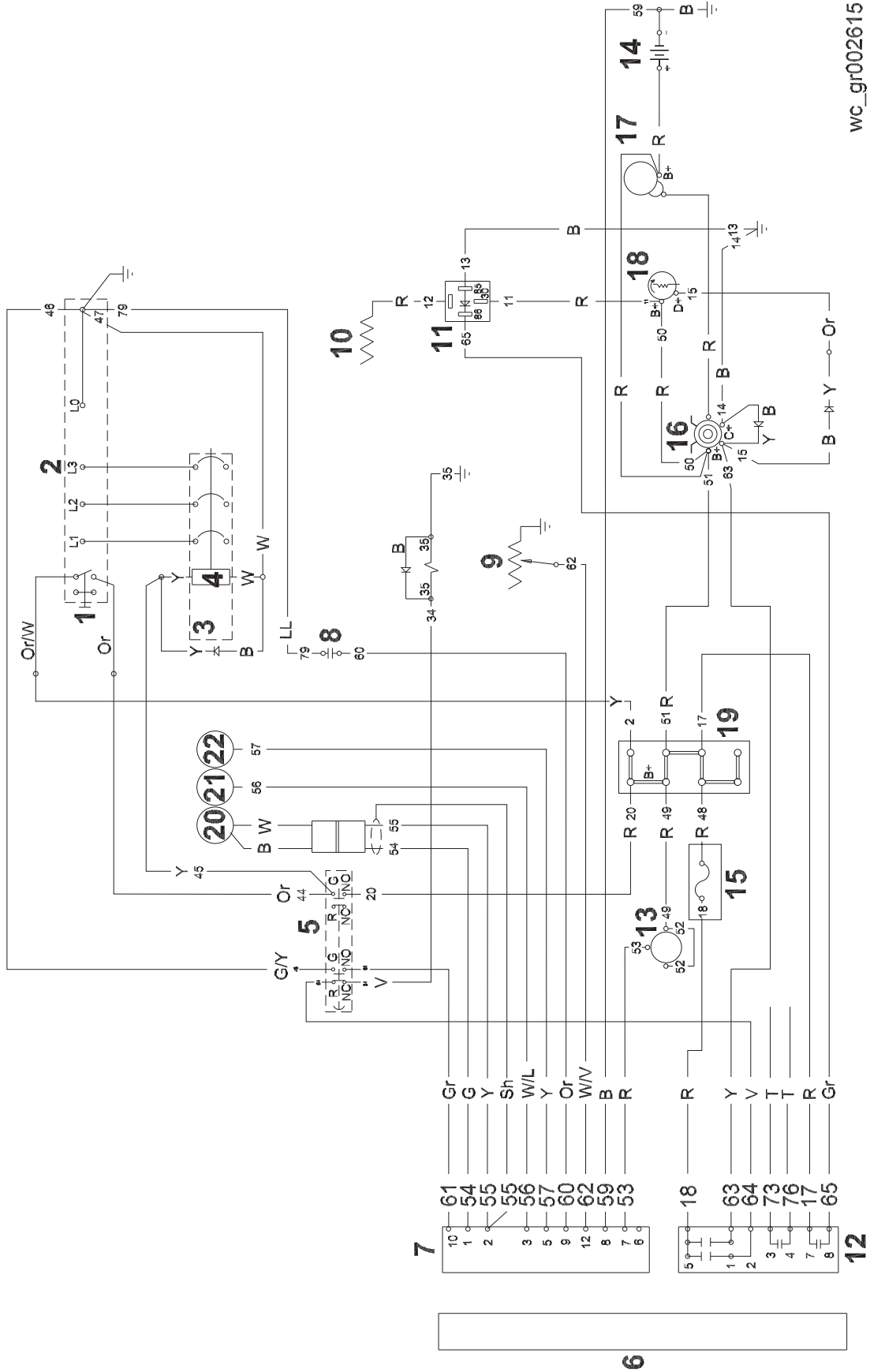

wc_gr002615

4.13 G 85 & G 70 w/ECU Engine Wiring

BOM	Revision	See Graphic:	Revision	See Graphic:
0009369	124 & higher	wc_gr004614	123 & lower	wc_gr002616
0009459	133 & higher	wc_gr004614	132 & lower	wc_gr002616
0620003	129 & higher	wc_gr004614	128 & lower	wc_gr002616
0620350		wc_gr004614		
0620351		wc_gr004614		
0620352		wc_gr004614		

Engine

Ref.	Description	Ref.	Description
1	Safety interlock switch	11	Intake heater relay
2	Mechanical lugs	12	Plug 2 - engine start outputs
3	Main circuit breaker	13	Run/off/auto switch
4	Shunt	14	Battery
5	Emergency Stop switch	15	10A fuse
6	Engine control module	16	Starter relay
7	Plug 1 - engine sender inputs	17	Starter
8	Remote start contacts	18	Alternator
9	Fuel level sender	19	Terminal block
10	Intake heater		

Wires

Ref.	Description	Ref.	Description
18	Battery +	62	Fuel Level
53	Battery +	63	Crank
56	Cold Crank Delay	64	Run/Fuel
59	Battery -	73	Remote Annunciator
60	Remote Start	75	Remote Annunciator
61	E-Stop		

Wire Colors							
B	Black	R	Red	Y	Yellow	Or	Orange
G	Green	T	Tan	Br	Brown	Pr	Purple
L	Blue	V	Violet	Cl	Clear	Sh	Shield
P	Pink	W	White	Gr	Gray	LL	Light blue

G 85 & G 70 w/ECU Engine Wiring

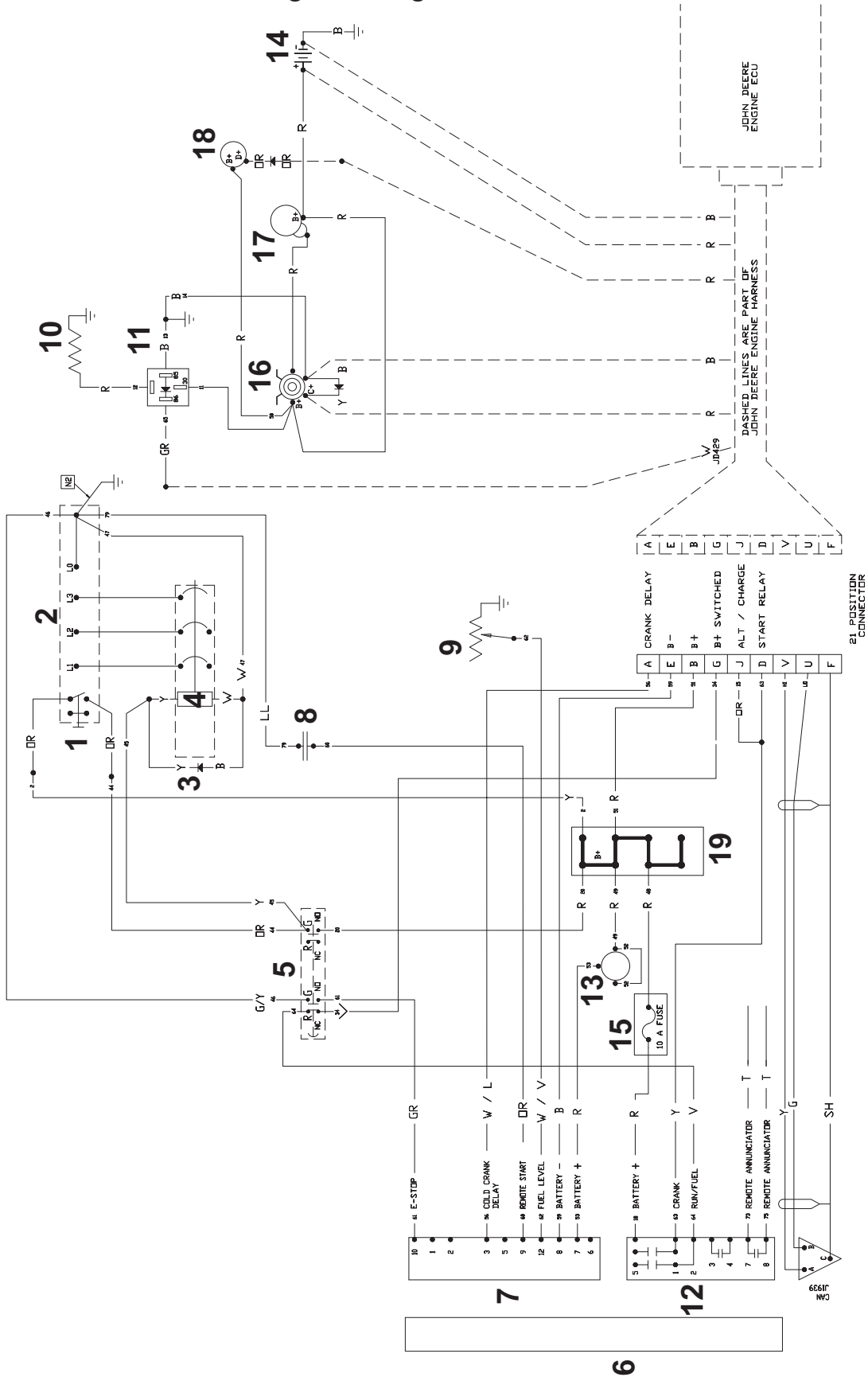

wc_gr004614

BOM	Revision	See Graphic:	Revision	See Graphic:
0009369	124 & higher	wc_gr004614	123 & lower	wc_gr002616
0009459	133 & higher	wc_gr004614	132 & lower	wc_gr002616
0620003	129 & higher	wc_gr004614	128 & lower	wc_gr002616
0620350		wc_gr004614		
0620351		wc_gr004614		
0620352		wc_gr004614		

Engine

Ref.	Description	Ref.	Description
1	Safety interlock switch	11	Intake heater relay
2	Mechanical lugs	12	Plug 2 - engine start outputs
3	Main circuit breaker	13	Run/off/auto switch
4	Shunt	14	Battery
5	Emergency Stop switch	15	10A fuse
6	Engine control module	16	Starter relay
7	Plug 1 - engine sender inputs	17	Starter
8	Remote start contacts	18	Alternator
9	Fuel level sender	19	Terminal block
10	Intake heater		

Wires

Ref.	Description	Ref.	Description
18	Battery +	62	Fuel Level
53	Battery +	63	Crank
56	Cold Crank Delay	64	Run/Fuel
59	Battery -	73	Remote Annunciator
60	Remote Start	75	Remote Annunciator
61	E-Stop		

Wire Colors							
B	Black	R	Red	Y	Yellow	Or	Orange
G	Green	T	Tan	Br	Brown	Pr	Purple
L	Blue	V	Violet	Cl	Clear	Sh	Shield
P	Pink	W	White	Gr	Gray	LL	Light blue

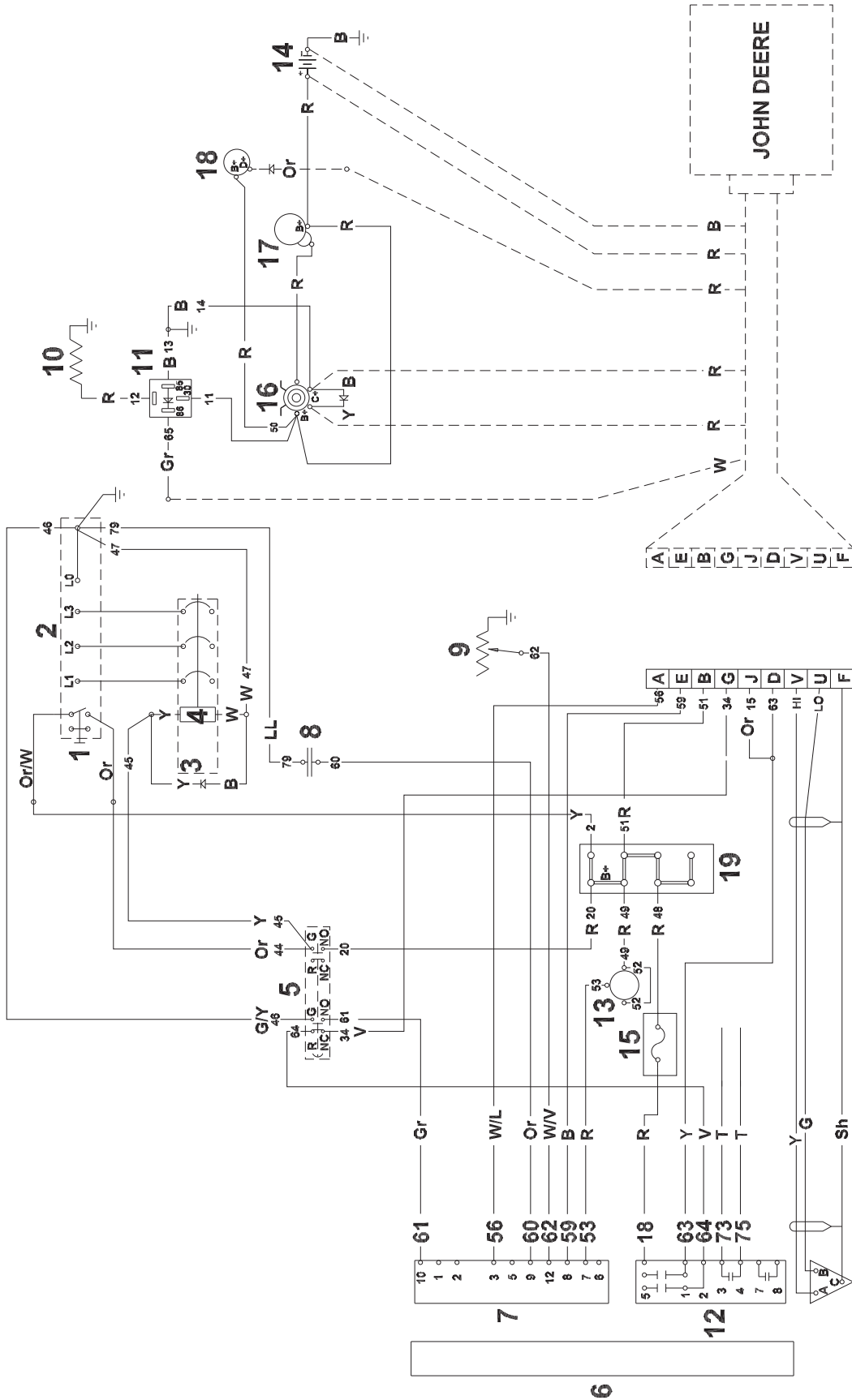

WC_gr002616

5 Factory-Installed Options

This machine may be equipped with one or more of the following factory-installed options. To verify if any of these options are installed on your machine, contact the WACKER Corporation at 1-800-770-0957. A nameplate listing the Model Number, Item Number, Revision, and Serial Number is attached to each unit. Please have this information available when contacting WACKER Corporation.

5.1 Block Heater

See Graphic: *wc_gr001709*

The engine block heater option includes a block heater **(a)** with a cord **(b)**. The function of the block heater is to heat the engine coolant/engine block to improve cold-weather engine starting. Plug the cord into a 120V power supply.

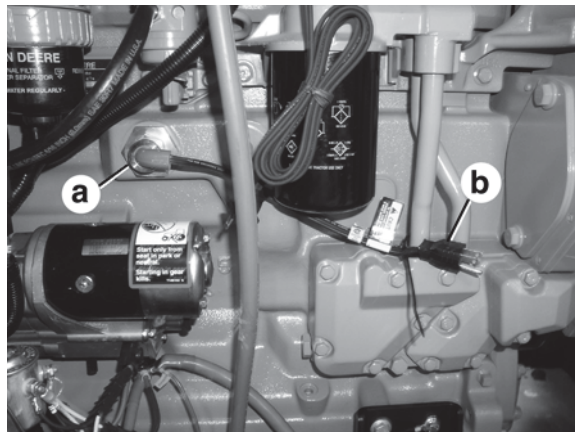

wc_gr001709

5.2 Fuel/Water Separator

See Graphic: *wc_gr001705*

The fuel/water separator separates water from the fuel on models with Isuzu engines. Empty the separator water bowl (**a**) as needed by opening the water bowl drain (**b**). The separator element should be changed each time the fuel filter is changed—approximately every 600 hours of operation.

To change the element:

- 5.2.1 Loosen the element retainer (**d**) and remove the retainer and element (**c**) from the separator head.
- 5.2.2 Unscrew the water bowl from the element.

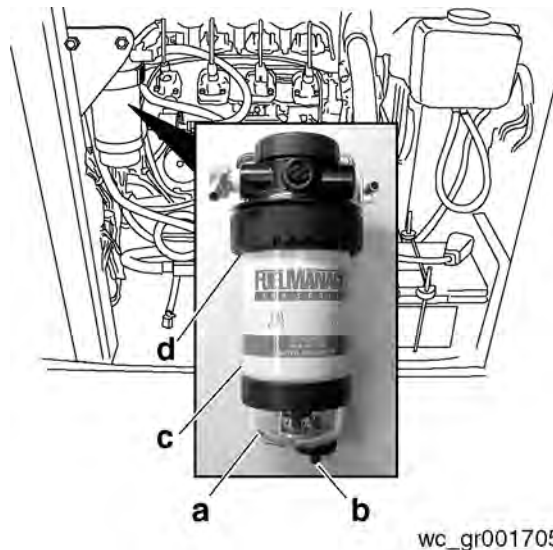

wc_gr001705

5.3 Electronic Governor

See Graphic: *wc_gr001714*, *wc_gr001715*, *wc_gr001716*, *wc_gr001717*

The electronic governor option consists of an electronic module (a or b) and an electronic actuator (c or d). The module senses rotation of the flywheel, then sends a signal to the electronic actuator that governs the fuel injection system. The system is designed to precisely regulate engine rpm, and thus frequency, to within approximately 0.25%. See electronic governor manufacturer's literature for detailed information.

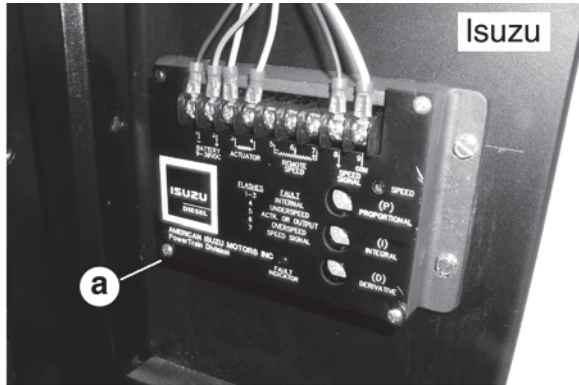

wc_gr001715

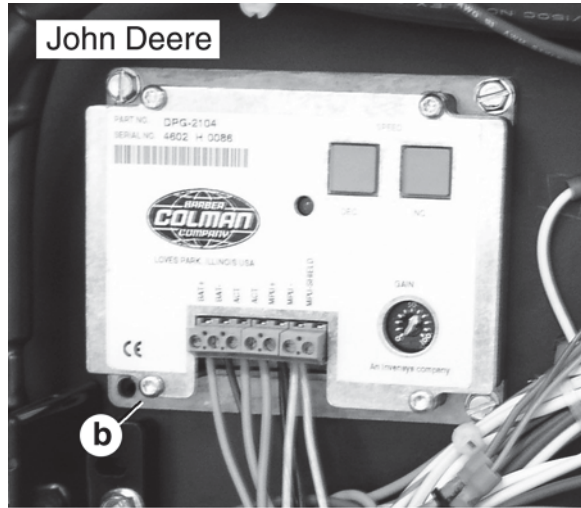

wc_gr001716

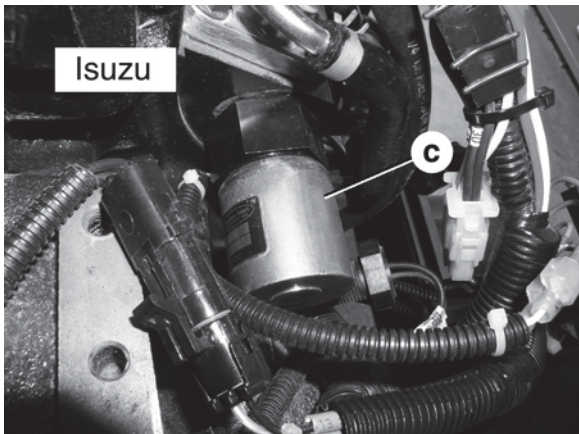

wc_gr001717

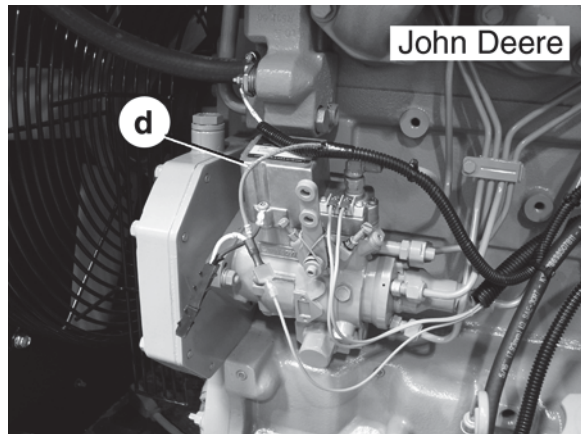

wc_gr001714

5.4 LCD Strip Heater

See Graphic: *wc_gr001724, wc_gr001725*

The LCD strip heater option includes a thermostat module **(a)** and a clear heater strip that is bonded to the LCD **(b)** of the ECM. The purpose of the strip heater is to prevent the LCD from being damaged by extremely cold temperatures. The resistance of the coiled element of the heater is sensed by the thermostat. The resistance of the element changes with temperature. At approximately -30°C, the resistance value triggers the thermostat to send power to the element. The LED **(c)** of the thermostat module flashes during operation.

It is important to note that the LCD strip heater is always on and thus draws power (a very small amount) from the battery even when the unit is not running. If the battery should fail, the heater will also fail. Be sure to keep the battery charged when the generator is not in use.

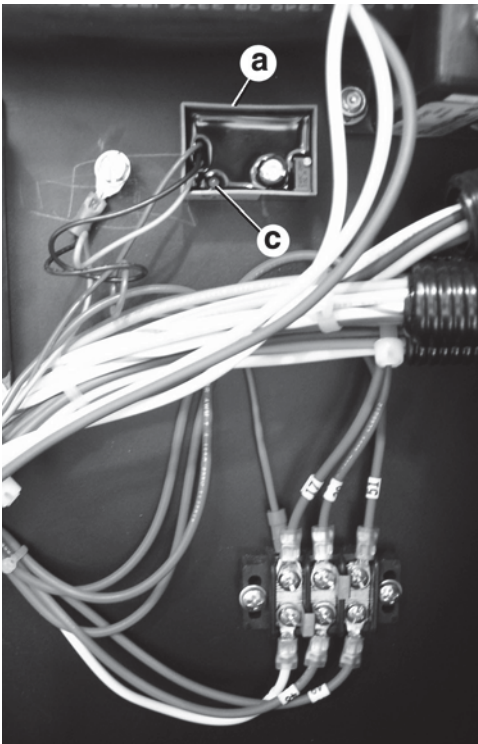

wc_gr001723

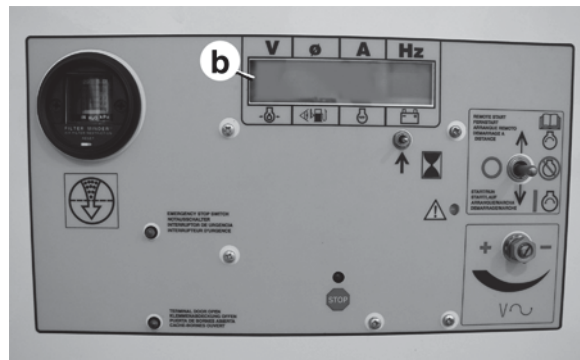

wc_gr001724

5.5 Low Coolant Shutdown

See Graphic: *wc_gr001708*

The low-coolant shutdown system consists of an electronic sensor that monitors coolant level. The sensor **(a)** is mounted to the radiator and wired into the ECM. The sensor probe **(b)** is submerged in radiator coolant. If the probe senses no coolant, it sends a signal to the ECM. The ECM program includes a 10-second timer to protect from nuisance shutdowns. If after the ten seconds coolant levels are still sensed as being low, the ECM shuts down the engine. The ECM will then display the “FAULT LOW WATER LEVEL”. Allow the engine to cool before adding additional coolant.



NEVER remove the radiator cap while the engine is hot! Pressurized coolant can cause serious burns.

If it is necessary to open the radiator, only do so with the engine off, and only when coolant is cool enough to touch with bare hands. Slowly loosen the radiator cap to relieve pressure first, before removing it completely.

Note: *The sensor may be disabled by unplugging the wire harness. This action will not shut down the machine.*

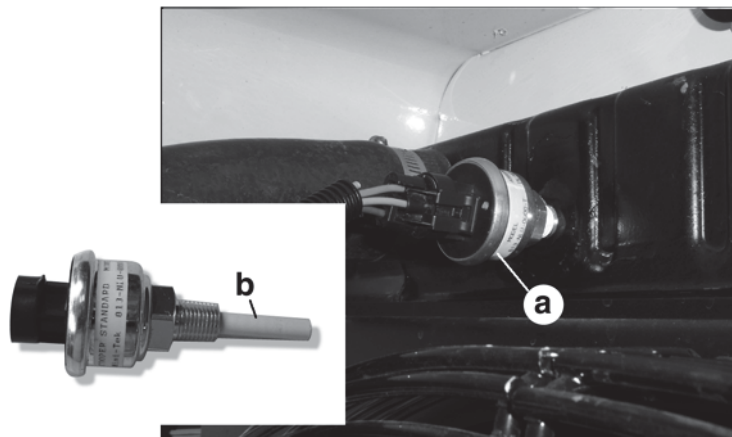

wc_gr001708

5.6 Lube Level Maintainer

See Graphic: *wc_gr001711, wc_gr001712, wc_gr001713*

The lube level maintainer system protects the engine from low oil levels by providing an additional 6-quart oil reservoir. Oil from the reservoir is gravity-fed from the oil reservoir **(a)** through the control valve **(b)** and into the engine oil pan as needed. The valve includes a sightglass **(c)** through which the oil level can be seen. This oil level is the same as that measured by the engine dipstick. A float inside the valve detects low oil levels and opens the valve to supply the needed oil. The system is wired to the ECM and includes a low oil shutdown in case the oil in the reservoir is depleted. If the engine shuts down due to low oil, the ECM will display “FAULT LOW OIL LEVEL”. Fill the engine and the additional oil reservoir with oil before placing the generator back into service.

Note: *On machines with the Isuzu engine, the reservoir is mounted to the enclosure door.*

NOTICE: To prevent overfilling the engine with oil, place the shutoff valve **(d)** in the closed position when moving or towing the generator. Once the generator is in position, open the valve.

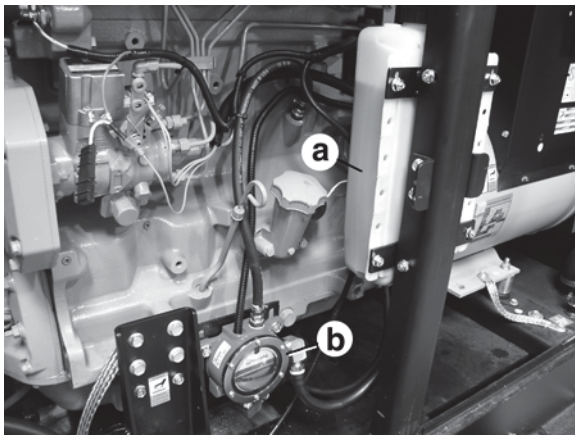

wc_gr001711

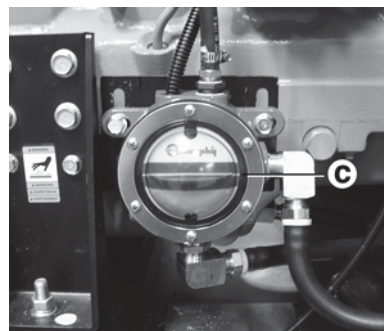

wc_gr001712

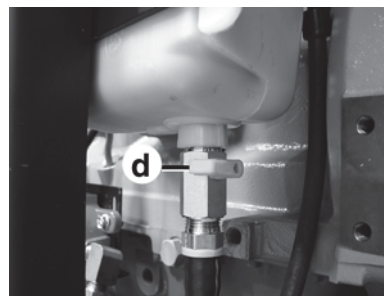

wc_gr001713

5.7 Temperature-Activated Shutters

See Graphic: *wc_gr001706, wc_gr001707*

The shutters (a) are mounted to the top of the generator enclosure. The shutters are designed to keep the engine compartment warm, thus increasing engine temperature during cold weather operation. The shutters are activated through a wax-pellet actuator (b) that is connected to the generator's cooling system. As radiator coolant warms, the wax-pellet actuator engages a linkage (c) that opens the shutters. As the coolant cools, the shutters close.

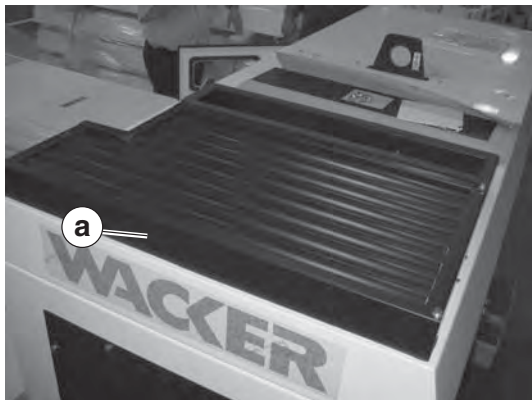

wc_gr001707

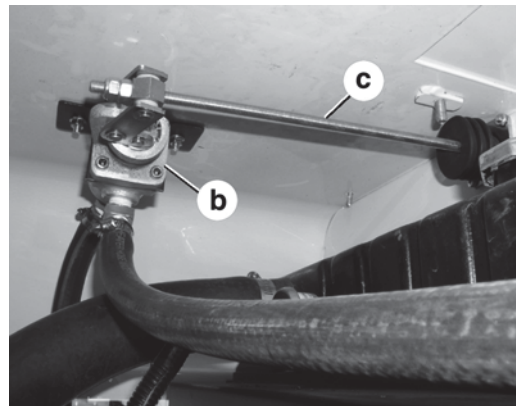

wc_gr001706

5.8 Lockable Battery Disconnect

See Graphic: *wc_gr004338*

A lockable ON/OFF switch is available which disconnects the battery. A padlock (not included) securely locks the switch in the OFF position. If equipped, the battery disconnect switch is mounted to the upper skid beneath the access door on either the right or left side of the machine.

NOTICE: Do not use the battery disconnect switch while the engine is running. Damage to electrical components may occur.



SWITCH

wc_gr004338

Notes:

5.9 Wiring Diagram

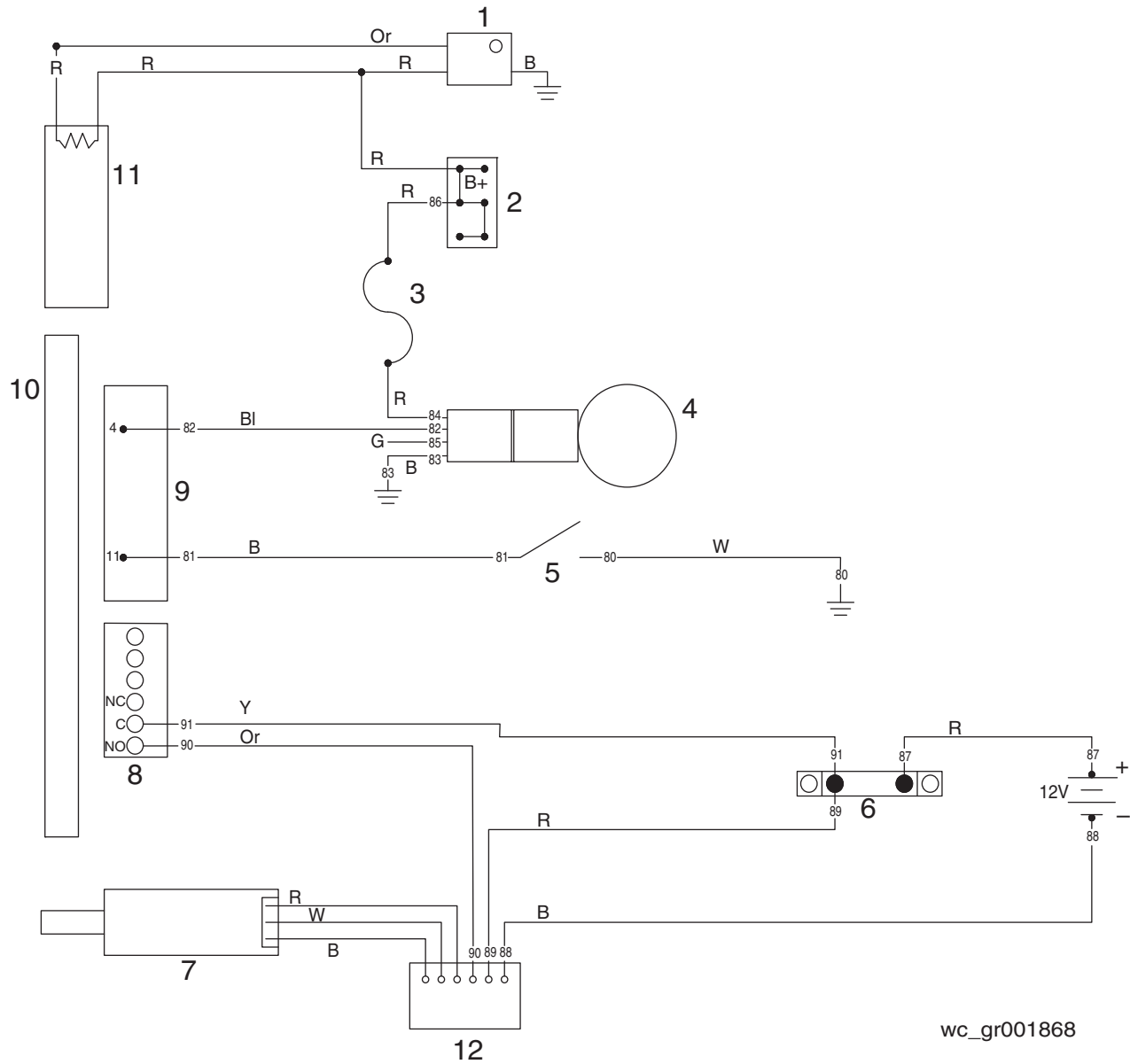

Wire Colors							
B	Black	R	Red	Y	Yellow	Or	Orange
G	Green	T	Tan	Br	Brown	Pr	Purple
L	Blue	V	Violet	Cl	Clear	Sh	Shield
P	Pink	W	White	Gr	Gray	LL	Light blue

5.10 Wiring Diagram Components

See Graphic: wc_gr001868

Ref	Description	Ref	Description
1	Thermostat module	7	Positive air shutoff solenoid actuator
2	Terminal block	8	Auxiliary relay terminals
3	1 Amp fuse	9	Plug 1, engine sensor inputs
4	Water level sensor	10	Electronic control board
5	Lube level maintainer low level switch	11	LCD heater
6	30 Amp circuit breaker	12	Positive air shutoff relay module

5.11 Cam-Lock

See Graphic: *wc_gr002584*

A second optional outlet panel features cam-lock connectors (**u**) for easy tool changes. The door is equipped with an interlock switch (**q**). When the door is opened this switch automatically trips the main circuit breaker.

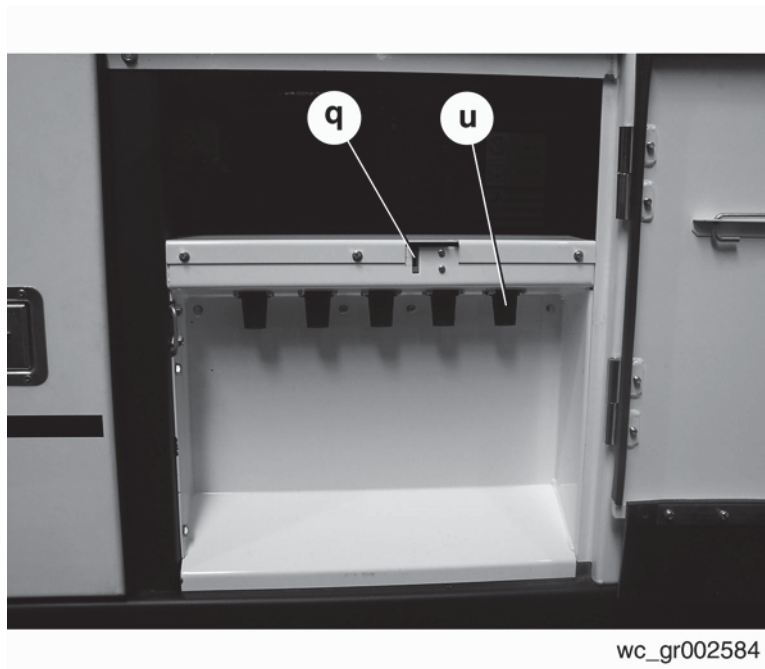

wc_gr002584

5.12 Containment System

See Graphic: *wc_gr002647*

Overspills and leaks are captured in the containment system. The containment system holds over 110% of the fluid contained in the machine.

The containment system should be checked every 50 hours or 2 weeks and drained when necessary. If fluid is found in the containment tank, trace the cause of the leak and correct.

Note: *In the interests of environmental protection, place impermeable sheeting and a container under the machine to collect the liquid which drains off. Dispose of this liquid in accordance with environmental protection legislation.*

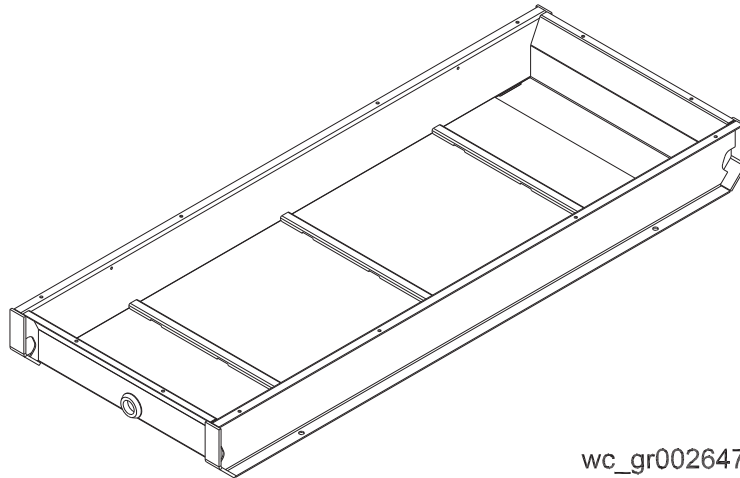

wc_gr002647

6. Technical Data

6.1 Engine Data

Item Number:	G 50 0009366 0009467 0620001 Rev. 112 & lower	G 70 0009367 0009468 0620002 Rev. 113 & lower	G 70 0620350 0620352	G 85 0009369 0009459 0620003 Rev. 114 & lower
Engine				
Engine make / type	John Deere / 4.5L			
Model	4045DF270	4045TF270	4045TF285	4045TF275
Number of cylinders	4			
Displacement l (in ³)	4.5 (274.6)			
Engine speed rpm	1800			
Power @ 1800 rpm kW/Hp	50/67	74.5/100	74/99	84.2/113
Coolant capacity l (qts.)	22.7 (24)	22.7 (24)	26.5 (28)	22.7 (24)
Oil capacity l (qts.)	15 (15.9)			
Battery Volts/CCa	12/720			
Fuel type	Diesel			
Fuel tank capacity l (gal.)	337 (89)			
Fuel consumption, continuous load l/hr (gal./hr)	12.5 (3.3)	17.4 (4.6)	18.7 (4.9)	21.2 (5.6)
Running time, continuous load Hours	27	19.3	18.2	16

Item Number:	G 50 0620001 Rev. 113 & above	G 70 0620002 Rev. 114 & above	G 70 0620351	G 85 0620003 Rev. 115 & above
Engine				
Engine make / type	John Deere / 4.5L			
Model	4045DF270	4045TF270	4045TF285	4045TF275
Number of cylinders	4			
Displacement l (in ³)	4.5 (274.6)			
Engine speed rpm	1800			
Power @ 1800 rpm kW/Hp	50/67	74.5/100	74/99	84.2/113
Coolant capacity l (qts.)	22.7 (24)	22.7 (24)	26.5 (28)	22.7 (24)
Oil capacity l (qts.)	15 (15.9)			
Battery Volts/CCa	12/1000			
Fuel type	Diesel			
Fuel tank capacity l (gal.)	337 (89)			
Fuel consumption, continuous load l/hr (gal./hr)	12.5 (3.3)	17.4 (4.6)	18.7 (4.9)	21.2 (5.6)
Running time, continuous load Hours	27	19.3	18.2	16

6.2 Generator Data

Item Number:	G 50 0009366 0009467 0620001	G 70 0009367 0009468 0620002	G 70 0620350 0620351 0620352	G 85 0009369 0009459 0620003
Generator				
Make/Type	Mecc Alte / Brushless			
Model	ECO32-3S/4	ECO32-2L/4	ECO32-3L/4	ECO32-3L/4
Generator speed rpm	1800			
Voltage selector switch	3 position			
AC voltages available	120/240 zig-zag 120/208 low-wye 277/480 Hi-wye			
Frequency	60 Hz			
Power factor 1Ø 3Ø	1.0 0.8			
Voltage regulation	±1.00%			
Insulation class	H			
Sound level at 7 m (23 ft.) dB(A)	66		68	69
AC receptacles	2 duplex, 3 twist-lock			
1Ø 120 GFI duplex Amps	2-20			
1Ø 120/240 V twist lock Amps	1-30A 2-50A			
Standby Output kW/ kVA	42/53	63/79		74/92
Continuous Output kW/ kVA	38/48	58/72		67/84
Main breaker Amps	175	225		250

6.3 Trailer and Skid Data

Item Number:	G 50 0009366	G 50 0009467 0620001	G 70 0009367	G 70 0009468 0620002	G 70 0620350	G 70 0620351 0620352	G 85 0009369	G 85 0009459 0620003
Trailer and Skid								
Dry weight of skid kg (lbs.)	1432 (3157)	1473 (3247)	1509 (3328)	1550 (3418)	1608 (3544)	1648 (3634)	1580 (3484)	1621 (3574)
Operating weight of skid kg (lbs.)	1720 (3793)	1761 (3883)	1798 (3964)	1839 (4054)	1896 (4180)	1937 (4270)	1868 (4120)	1909 (4210)
Trailer weight kg (lbs.)								
Single axle								
Tandem axle	499 (1100)							
GVWR kg (lbs.)								
Single axle								
Tandem axle	2722 (6000)							
Surge brakes Fluid type	DOT3							
Tires size	ST225/75D-15D							

6.4 Dimensions

mm (inches)

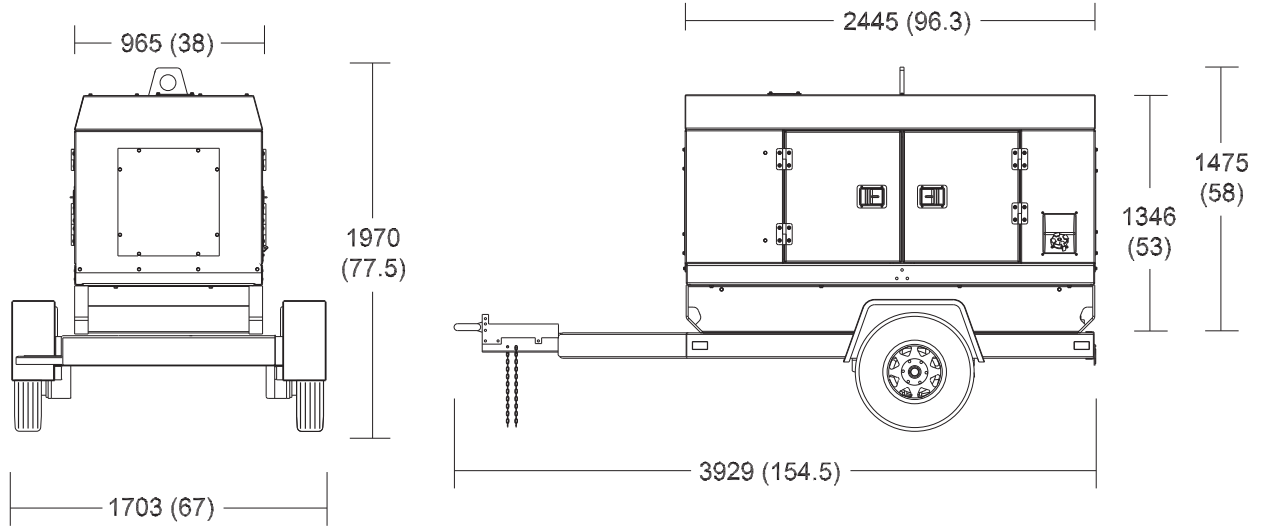

wc_gr002606

