

PJRC160

CORDLESS RE-BAR CUTTER
AKKU-BEWEHRUNGSSCHNEIDER
COUPE-BARRE D'ARMATURE SANS FIL
TAGLIATONDINI A BATTERIA
CORTADOR DE BARRAS DE ACERO
CORRUGADO INALÁMBRICO

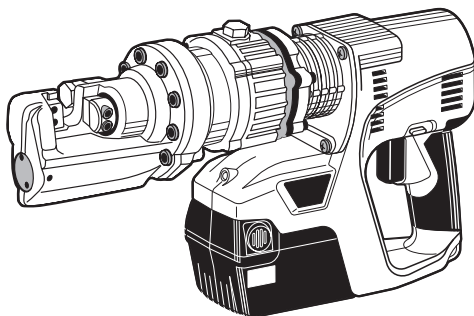

OPERATING AND MAINTENANCE MANUAL BETRIEBSANLEITUNG MANUEL D'UTILISATION ET D'ENTRETIEN MANUALE DI FUNZIONAMENTO E MANUTENZIONE MANUAL DE FUNCIONAMIENTO Y MANTENIMIENTO

Original Language English



WARNING

BEFORE USING THIS TOOL, STUDY THIS MANUAL TO ENSURE SAFETY WARNING AND INSTRUCTIONS.
KEEP THESE INSTRUCTIONS WITH THE TOOL FOR FUTURE REFERENCE.



WARNUNG

LESEN SIE VOR INBETRIEBNAHME DES GERÄTES DIE GEBRAUCHS- UND SICHERHEITSHINWEISE. BITTE BEWAHREN SIE DIE GEBRAUCHS- UND SICHERHEITSHINWEISE AUF, DAMIT SIE AUCH SPÄTER EINGESEHEN WERDEN KÖNNEN.



AVERTISSEMENT

AVANT D'UTILISER CET OUTIL, LIRE CE MANUEL ET LES CONSIGNES DE SÉCURITÉ AFIN DE GARANTIR UN FONCTIONNEMENT SÛR.
CONSERVER CE MANUEL EN LIEU SÛR AVEC L'OUTIL AFIN DE POUVOIR LE CONSULTER ULTÉRIEUREMENT.



ATTENZIONE

PRIMA DI USARE QUESTA MACCHINA, STUDIARE IL MANUALE PER PRENDERE ATTO DEGLI AVVERTIMENTI E DELLE ISTRUZIONI PER LA SICUREZZA.
TENERE QUESTE ISTRUZIONI INSIEME ALLO STRUMENTO PER CONSULTAZIONI FUTURE.



ADVERTENCIA

ANTES DE UTILIZAR ESTA HERRAMIENTA, LEA DETENIDAMENTE ESTE MANUAL PARA FAMILIARIZARSE CON LAS ADVERTENCIAS E INSTRUCCIONES DE SEGURIDAD.
CONSERVE ESTAS INSTRUCCIONES JUNTO CON LA HERRAMIENTA PARA FUTURAS CONSULTAS.

INDEX INHALTSVERZEICHNIS TABLE DES MATIÈRES INDICE ÍNDICE

ENGLISH	Page	5	to	16
DEUTSCH	Page	17	to	28
FRANÇAIS	Page	29	to	40
ITALIANO	Page	41	to	52
ESPAÑOL	Page	53	to	64

EC DECLARATION OF CONFORMITY Page 71

www.max-europe.com

DEFINITIONS OF SIGNAL WORDS

- WARNING:** Indicates a potentially hazardous situation which, if not avoided, could result in death or serious injury.
- CAUTION:** Indicates a potentially hazardous situation which, if not avoided, may result in minor or moderate injury.
- NOTE:** Emphasizes essential information.

DEFINITIONEN DER HINWEISBEZEICHNUNGEN

- WARNUNG:** Zeigt eine eventuell gefährliche Situation an, die den Tod oder schwere Verletzungen zur Folge haben könnte, wenn sie nicht vermieden wird.
- VORSICHT:** Zeigt eine eventuell gefährliche Situation an, die leichte oder mittelschwere Verletzungen zur Folge haben könnte, wenn sie nicht vermieden wird.
- HINWEIS:** Hebt wichtige Informationen hervor.

DÉFINITIONS DES DIFFÉRENTS DEGRÉS D' AVERTISSEMENTS

- AVERTISSEMENT:** Indique une situation éventuellement dangereuse qui, si elle n'est pas contournée, pourrait provoquer la mort ou des blessures sérieuses.
- ATTENTION:** Indique une situation éventuellement dangereuse qui, si elle n'est pas contournée, pourrait provoquer des blessures légères à moyennement sérieuses.
- REMARQUE:** Souligne des informations importantes.

DEFINIZIONE DELLE INDICAZIONI DI AVVERTIMENTO

- ATTENZIONE:** Indica l'eventualità che possa verificarsi una situazione pericolosa, la quale se non viene evitata, può risultare letale o provocare gravi lesioni.
- AVVERTENZA:** Indica l'eventualità che possa verificarsi una situazione pericolosa, la quale se non viene evitata, può provocare lesioni di lieve o media entità.
- NOTA:** Evidenzia informazioni importanti.

DEFINICIÓN DE LAS INDICACIONES DE ADVERTENCIA

- ADVERTENCIA:** Indica una situación potencialmente peligrosa que podría causar la muerte o graves lesiones si no se evita.
- PRECAUCIÓN:** Indica una situación potencialmente peligrosa que podría causar lesiones menos graves o leves si no se evita.
- NOTA:** Resalta informaciones importantes.

**Fig.A
Abb.A**

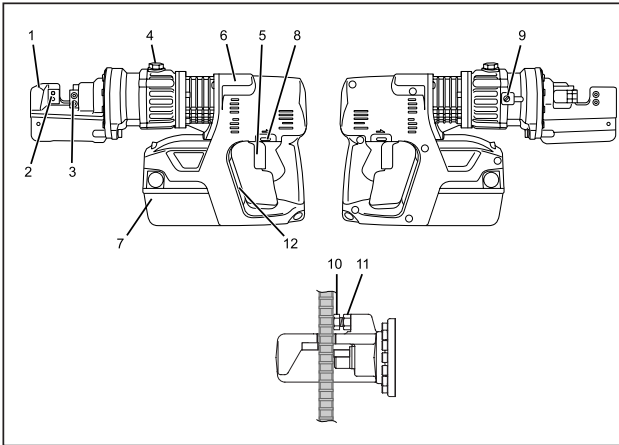

Fig.B / Abb.B

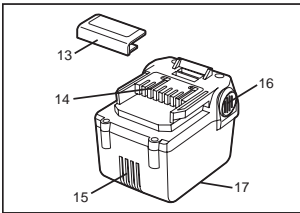

Fig.C / Abb.C

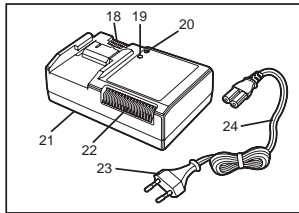

Fig.D / Abb.D

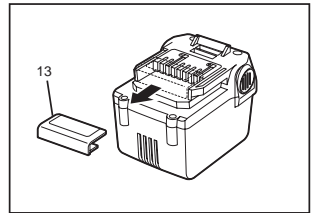

Fig.E / Abb.E

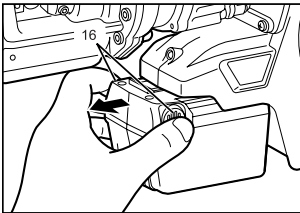

Fig.F / Abb.F

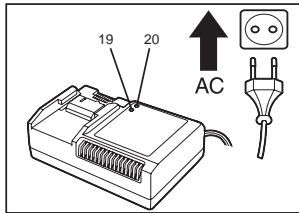

Fig.G / Abb.G

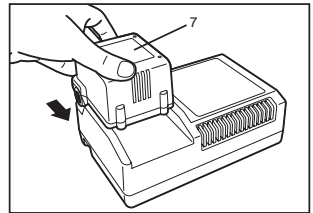

Fig.H / Abb.H

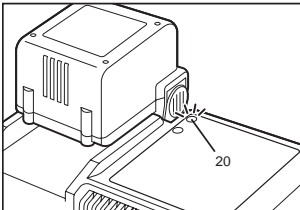

Fig.I / Abb.I

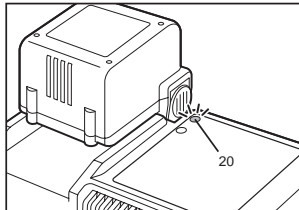

Fig.J / Abb.J

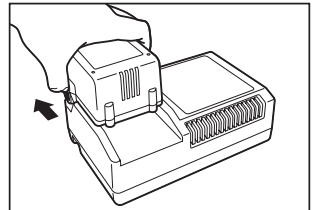

Fig.K / Abb.K

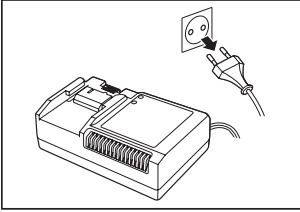

Fig.L / Abb.L

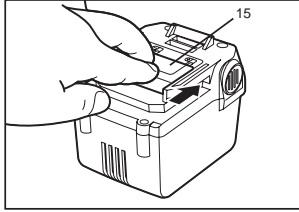

Fig.M / Abb.M

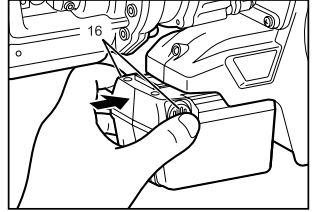

Fig.O / Abb.O

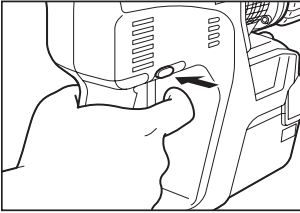

Fig.P / Abb.P

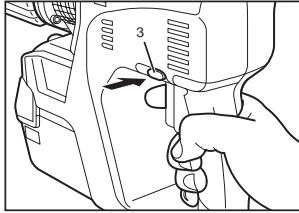

Fig.Q / Abb.Q

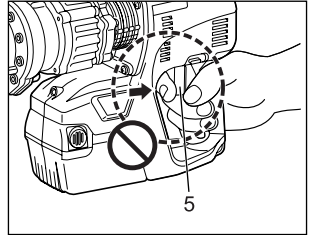

Fig.R / Abb.R

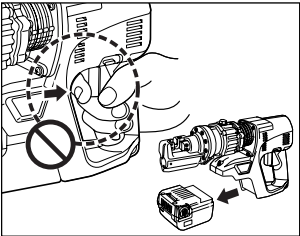

Fig.S / Abb.S

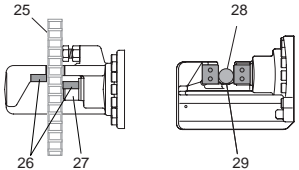

Fig.T / Abb.T

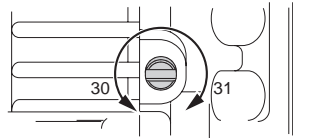

Fig.U / Abb.U

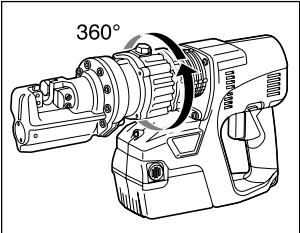

Fig.V / Abb.V

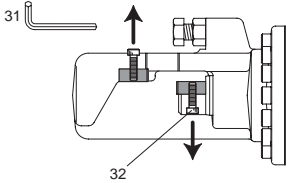
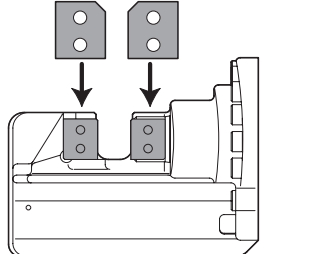

Fig.W / Abb.W



ENGLISH

OPERATING AND MAINTENANCE MANUAL

INDEX

1. GENERAL POWER TOOL SAFETY WARNINGS.....	5
2. REBAR CUTTER SAFETY WARNINGS.....	8
3. TECHNICAL DATA	10
4. BATTERY INSTRUCTIONS	12
5. OPERATING INSTRUCTIONS.....	15
6. MAINTENANCE.....	16
7. STORAGE	16

1. GENERAL POWER TOOL SAFETY WARNINGS



WARNING

READ ALL SAFETY WARNINGS AND ALL INSTRUCTIONS.

Failure to follow the warnings and instructions may result in electric shock, fire and/or serious injury. **Save all warnings and instructions for future reference.** The term "power tool" in the warnings refers to your mains-operated (corded) power tool or battery-operated (cordless) power tool.

1. WORK AREA SAFETY

- **Keep work area clean and well lit.** Cluttered or dark areas invite accidents.
- **Do not operate power tools in explosive atmospheres, such as in the presence of flammable liquids, gases or dust.** Power tools create sparks which may ignite the dust or fumes.
- **Keep children and bystanders away while operating a power tool.** Distractions can cause you to lose control.

2. ELECTRICAL SAFETY

- **Power tool plugs must match the outlet. Never modify the plug in any way. Do not use any adapter plugs with earthed (grounded) power tools.** Unmodified plugs and matching outlets will reduce risk of electric shock.
- **Avoid body contact with earthed or grounded surfaces, such as pipes, radiators, ranges and refrigerators.** There is an increased risk of electric shock if your body is earthed or grounded.
- **Do not expose power tools to rain or wet conditions.** Water entering a power tool will increase the risk of electric shock.

- **Do not abuse the cord. Never use the cord for carrying, pulling or unplugging the power tool. Keep cord away from heat, oil, sharp edges and moving parts.** Damaged or entangled cords increase the risk of electric shock.
- **When operating a power tool outdoors, use an extension cord suitable for outdoor use.** Use of a cord suitable for outdoor use reduces the risk of electric shock.



- **Do not use the power tool in the rain, where water is splashing, in a wet place, or in a damp place.** Using the tool in these or similar conditions will increase the risk of electric shock, dangerous malfunction, and overheating. **If operating a power tool in a damp location is unavoidable, use a residual current device (RCD) protected supply.** Use of an RCD reduces the risk of electric shock.

3. PERSONAL SAFETY

- **Stay alert, watch what you are doing and use common sense when operating a power tool. Do not use a power tool while you are tired or under the influence of drugs, alcohol or medication.** A moment of inattention while operating power tools may result in serious personal injury.



- **Use personal protective equipment. Always wear eye protection.** Protective equipment such as dust mask, non-skid safety shoes, hard hat, or hearing protection, hand protector used for appropriate conditions will reduce personal injuries.
- **Prevent unintentional starting. Ensure the switch is in the off-position before connecting to power source and/or battery pack, picking up or carrying the tool.** Carrying power tools with your finger on the switch or energizing power tools that have the switch on invites accidents.
- **Remove any adjusting key or wrench before turning the power tool on.** A wrench or a key left attached to a rotating part of the power tool may result in a personal injury.
- **Do not overreach. Keep proper footing and balance at all times.** This enables better control of the power tool in unexpected situations.
- **Dress properly. Do not wear loose clothing or jewellery.** Keep your hair, clothing and gloves away from moving parts. Loose clothes, jewellery or long hair can be caught in moving parts.
- **If devices are provided for the connection of dust extraction and collection facilities, ensure these are connected and properly used.** Use of dust collection can reduce dust-related hazards.

4. POWER TOOL USE AND CARE

- **Do not force the power tool. Use the correct power tool for your application.** The correct power tool will do the job better and safer at the rate for which it was designed.
- **Do not use the power tool if the switch does not turn it on and off.** Any power tool that cannot be controlled with the switch is dangerous and must be repaired.
- **Disconnect the plug from the power source and/or the battery pack from the power tool before making any adjustments, changing accessories, or storing power tools.** Such preventive safety measures reduce the risk of starting the power tool accidentally.
- **Store idle power tools out of the reach of children and do not allow persons unfamiliar with the power tool or these instructions to operate the power tool.**

Power tools are dangerous in the hands of untrained users.

- **Maintain power tools. Check for misalignment or binding of moving parts, breakage of parts and any other condition that may affect the power tool's operation. If damaged, have the power tool repaired before use.** Many accidents are caused by poorly maintained power tools.
- **Keep cutting tools sharp and clean.** Properly maintained cutting tools with sharp cutting edges are less likely to bind and are easier to control.
- **Use the power tool, accessories and tool bits etc. in accordance with these instructions, taking into account the working conditions and the work to be performed.** Use of the power tool for operations different from those intended could result in a hazardous situation.

5. BATTERY TOOL USE AND CARE



- **DO NOT DISPOSE OF BATTERY PACKS/BATTERIES INTO FIRE OR WATER.** Battery packs/batteries should be collected, recycled or disposed of in an environmental-friendly manner.



- **PROTECT THE BATTERY AGAINST HEAT, ALSO AGAINST CONTINUOUS SUN IRRADIATION AND FIRE.** There is danger of explosion.



- **CHARGE THE BATTERY PACK IN A TEMPERATURE RANGE 5°(41F) TO 40°(104F)**



- **DO NOT DISPOSE OF POWER TOOLS INTO HOUSEHOLD WASTE.** According to the European Guideline 2002/96/EC for Waste Electrical and Electronic Equipment and its implementation into national right, power tools that are no longer usable must be collected separately and disposed of in an environmentally correct manner.
- **DEFECTIVE OR DEAD OUT BATTERY PACKS/BATTERIES MUST BE RECYCLED ACCORDING TO THE GUIDELINE 2006/66/EC.**
- **Recharge only with the charger specified by the manufacturer.** A charger that is suitable for one type of battery pack may create a risk of fire when used with another type of battery pack.
- **Use power tools only with specifically designated battery packs.** Use of any other battery packs may create a risk of injury and fire.
- **When battery pack is not in use, keep it away from other metal objects, like paper clips, coins, keys, nails, screws or other small metal objects, that can make a connection from one terminal to another.** Shorting the battery terminals together may cause burns or a fire.
- **Under abusive conditions, liquid may be ejected from the battery; avoid contact. If contact accidentally occurs, flush with water. If liquid contacts eyes, additionally seek medical help.** Liquid ejected from the battery may cause irritation or burns.

6. SERVICE

- **Have your power tool serviced by a qualified repair person using only identical replacement parts.** This will ensure that the safety of the power tool is maintained.

2. REBAR CUTTER SAFETY WARNINGS



1. KEEP HANDS AWAY FROM MOVING PARTS

2. BE SURE TO KEEP HANDS AWAY FROM THE TRIGGER SWITCH AND DETACH THE BATTERY PACK WHEN REPLACING THE BLADE, WHEN AB-NORMALITIES OCCUR, AND WHEN THE EQUIPMENT IS NOT BEING USED

Leaving the Battery pack installed in these situations may cause breakdowns or damage.

3. NEVER MODIFY THE TOOL

Modifying the tool will impair performance and operating safety. Any modification may lead to serious injury and void the tool warranty.

4. MAINTAIN THE TOOL IN GOOD OPERATING CONDITION (CHECK TIGHTNESS OF SCREWS BEFORE OPERATION)

To secure operating safety and ensure top performance, keep the tool free of wear and damage.

Under normal operation, the tool is designed to produce vibration. Due to the vibration, the screws can come loose, causing damage to the tool or serious injury.

Also keep the tool's hand grip dry and clean, especially free of oil and grease.

5. LET THE TOOL WARM UP FOR SEVERAL MINUTES BEFORE USE

In cold weather or when the tool has not been used for a long period of time, the internal lubrication in the tool might not be sufficient. In such cases, let the tool warm up for several minutes by operating it with no load. Lacking sufficient internal lubrication, the tool might not operate at full performance.

6. MAKE SURE THERE IS NO ONE BELOW WHEN USING THE TOOL IN HIGH LOCATIONS

Failure to do so may lead to serious injury of the person below.

7. HOLD THE TOOL FIRMLY WITH BOTH HANDS

Failure to do so may lead to serious injury.

8. DO NOT LEAVE THE TOOL RUNNING

Operate the tool only when hand-held.

9. USE ONLY THE AUTHORIZED BATTERY PACK

Use only MAX JPL925 battery pack. If the tool is connected to a power supply other than the authorized pack, such as a re-chargeable battery, a dry cell, or a storage battery for use in automobiles, the tool may be damaged, break down, overheat, or even catch on fire. Do not connect this tool to any power supply except the MAX JPL925 battery pack.

10. TO ENSURE MAXIMUM PERFORMANCE, FULLY CHARGE THE BATTERY BEFORE USE

A new battery pack or one not used for extended periods may have self-discharged and thus may need recharging to restore it to a fully charged condition. Before operating the tool, make sure to charge the Battery pack with the designated MAX Battery charger JC928.

11. DO NOT BLOCK THE VENTILATION HOLE OF THE TOOL. DO NOT PUT ANYTHING INTO THE VENTILATION HOLE.

The tool may heat up, emit smoke or break down.

It is very dangerous because foreign matter may be thrown from the tool.

12. DO NOT CONTINUOUSLY USE OF THE TOOL FOR EXTENDED PERIODS OF TIME.

The motor temperature and oil temperature will rise to the point that the tool cannot provide sufficient performance.

13. DO NOT DROP THE TOOL.

This may cause damage or malfunction.

When working in high locations, use due caution for the operating environment or surrounding persons.

14. USE ONLY THE SPECIFIED BLADES AND ACCESSORIES.

Unspecified blades and accessories may not only cause equipment trouble but also injury or accident.

15. USE ONLY THE SPECIFIED HYDRAULIC OIL.

Unspecified oil may cause equipment trouble and inadequate power, and adversely affect the tool.

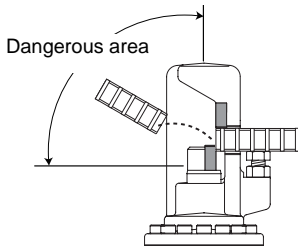

16. WHEN YOU CUT REBAR SHORT, THE CUT PIECE MAY BE THROWN AS SHOWN AT TOP, THEREFORE MAKE SURE THE AREA AROUND YOU IS SAFE BEFORE CUTTING THE REBAR.

17. BATTERY CHARGING PRECAUTION

- 1 Use only MAX Battery charger JC928 and Battery Pack JPL925**
Failure to do so may cause the Battery to over-heat or catch fire leading to serious injury.
- 2 Charge the Battery from AC between 100V and 240V wall sockets**
Failure to do so may result in overheating, or inadequate charging possibly causing serious injury.
- 3 Never use a transformer**
- 4 Never connect the Battery charger to an engine generator direct-current power supply**
The charger will break down or be damaged from burning.
- 5 Avoid charging the Battery pack in the rain, in a damp place, or where water is splashing**
The Battery charger is for indoor use. Charging a damp or wet Battery pack will cause an electric shock or a short circuit that may lead to damage from burning and even the tool catching on fire.
- 6 Do not touch the power cord or plug with a wet hand or glove**
This may cause injury from electric shock.
- 7 Do not put a cloth or any other cover on the Battery charger while the Battery pack is being charged**
This will cause overheating and damage from burning, or the Charger may even catch fire.
- 8 Keep the Battery pack and Battery charger away from heat and flames**
- 9 Do not charge the Battery pack near flammable materials**

10 Charge the Battery pack in a well ventilated place

Avoid charging the Battery pack where it will be in direct sunlight.

11 Avoid continual use of the Battery charger

Rest the Charger for 15 minutes between charges to avoid functional trouble with the unit.

12 Any objects that block the ventilation holes or Battery pack receptacle may cause electric shock or functional troubles

Operate the charger free of dust or other foreign materials.

13 Handle the power cord carefully

Do not carry the Battery charger by its power cord. Do not use the power cord to disconnect it from a wall socket; this will damage the cord and break the wires or cause a short circuit. Do not let the power cord contact sharp edged tools, hot materials, oil, or grease. A damaged cord must be repaired or replaced.

14 Do not charge non rechargeable batteries with this charger.

15 This charger is not intended for use by children or disabled persons without supervisor.

16 Children should be supervised to ensure that they do not play with the charger.

17 Put a pack cap on the terminal of the Battery pack

When the Battery pack is not in use, put a pack cap on its terminal to prevent short circuits.

Keep it away from other metal objects, such as clips, coins, keys, nails, screws or other small metal objects, that can make a connection from one terminal to another.

18 Do not leave or store the tool in a vehicle or in direct sunlight during summer. Leaving the tool in high temperature conditions may cause the battery pack to deteriorate.

19 Do not store a fully discharged battery pack. If a fully discharged battery pack is removed from the system and left for a long period of time, it may become damaged. Recharge the battery immediately when it has been discharged.

3. TECHNICAL DATA

1. NAME OF PARTS (See Fig. A, B and C)

Fig. A	1	HEAD
	2	BLADE
	3	CUTTER ROD
	4	OILING BOLT
	5	TRIGGER SWITCH
	6	MOTOR
	7	BATTERY PACK JPL925
	8	SAFETY LOCK SWITCH
	9	VALVE BOLT
	10	ADJUST BOLT
	11	LOCK NUT
	12	SPECIFICATION LABEL

Fig. B	13	PACK CAP
	14	TERMINAL
	15	VENTILATION WINDOW
	16	LATCH
	17	SPECIFICATION LABEL
Fig. C	18	BATTERY PACK ENTRY POINT
	19	LED LAMP (ORANGE) CHARGING STATUS INDICATOR LAMP
	20	LED LAMP (RED / GREEN) CHARGING STATUS INDICATOR LAMP
	21	SPECIFICATION LABEL
	22	VENTILATION WINDOW
	23	POWER CORD
	24	CE (VDE) POWER PLUG

2. TOOL SPECIFICATIONS

PRODUCT NO.	PJRC160
WEIGHT	7.6kg(16.8lbs.)(Battery included)
HEIGHT	228mm (9")
WIDTH	100mm (4")
LENGTH	389mm (15-3/8")
HYDRAULIC OIL	ISO VG46
VOLTAGE / BATTERY	25.2V, Li-ion Battery pack JPL925
MAXIMUM CUTTING DIAMATER	φ16mm (#5)
MOTOR	Brushless DC Motor
OPERATING TEMPERATURE	-5°C to 40°C (14°F to 104°F)
OPERATING HUMIDITY	80% RH or less

<Battery charger>

PRODUCT NAME	MAX lithium ion battery charger
PRODUCT NO.	JC928(CE)
INPUT	AC100-240V 50/60Hz 1.62-0.68A
OUTPUT	DC 7.2/10.8/14.4V 7A DC 18/21.6/25.2/28.8V 3.9A
WEIGHT	1.6kg (3.5lbs.)
OPERATING TEMPERATURE	5°C to 40°C (41°F to 104°F)
OPERATING HUMIDITY	80% RH or less

<Battery pack>

PRODUCT NAME	MAX lithium ion battery pack
PRODUCT NO.	JPL925
BATTERY TYPE	Lithium ion battery
NOMINAL VOLTAGE	DC25.2 V
NOMINAL CAPACITY	3.0 Ah (3,000 mAh)
CHARGING TIME (USE WITH JC928(CE))	Quick charging - Approximately 35 minutes (Apprx. 90% of capacity) Full charging - Approximately 45 minutes at 25°C(77°F) (100% of capacity)
ACCESSORIES	Pack cap (For preventing short circuit)
WEIGHT	0.9 kg (2.4lbs.)
CHARGING TEMPERATURE	5°C to 40°C (41°F to 104°F)
OPERATING TEMPERATURE	-5°C to 40°C (14°F to 104°F)
OPERATING HUMIDITY	80% RH or less

BATTERY CHARGER:

Use only an authorized Battery charger, MAX JC928.

3. TECHNICAL DATA

① NOISE

The typical A-weighted noise level determined according to EN60745-2-6:

- Sound pressure level (L_{pA}): 91dB (A)
- Sound power level (L_{WA}): 80dB (A)
- Uncertainty (K): 3dB (A)



Wear ear protection

② VIBRATION

The vibration total value (tri-axial vector sum) determined according to EN60745-1:

- Vibration emission: (a_h, HD): $\leq 2.5m/s^2$
- Uncertainty (K): 1.5m/s²

③ RADIATED EMISSION 30-1000 MHZ

Class B

④ Overvoltage category

PRODUCT	Overvoltage category
PJRC160 CORDLESS RE-BAR CUTTER	Category 1 according to IEC 60664-1
JC928(CE) BATTERY CHARGER	Category 2 according to IEC 60664-1

⑤ Pollution degree

Pollution degree : degree 4 according to IEC 60664-1 (Both of PJRC160 and JC928(CE)).

4. APPLICATIONS

Cutting of the following materials

- Rebar
- Bolt
- Mesh Wire

5. ABOUT PRODUCTION YEAR

This product bears production number in the body. The two digits of the number from left indicates the production year.

(Example)

0 8 8 2 6 0 3 5 D

└
Year 2008

4. BATTERY INSTRUCTIONS

1. CHARGING



WARNING

- Before removing the Battery pack from the tool, press the Safety Lock switch as shown in the Fig.P, and keep hands away from the Trigger switch(Fig. A5).

- ① (Fig. D) A Pack cap(Fig. D 13) that is used to prevent short circuits must be removed from the terminal of the Battery pack. (Fig. E) When charging the Battery pack, remove it from the tool by pushing on its latches (Fig. E 16) from both sides while firmly holding the grip of the tool.
- ② (Fig. F) Plug the charger into a wall socket (100V - 240V). The red light, a current-carrying indicator, (Fig. F 20) will flash on and off with two short (Pipi) beep sounds.

WHEN THE ORANGE STANDBY LIGHT IS LIT

When the Battery pack is hot (after continuous use or exposure to direct sunlight) the Charger will automatically switch to standby to protect the Battery. The orange standby light will be lit until the Battery's temperature lowers to a safe level. The Battery will then be charged automatically.

WHEN THE BATTERY PACK IS AT LOW TEMPERATURE

When the Battery pack is at low temperature, its charging is automatically suspended until its temperature increases (higher than 5°C (41°F)), in order to protect it, even if it is set in the Charger.

Leave the Battery pack at normal temperature in the room for some time, and then, charge it again.

WHEN THE ORANGE STANDBY LIGHT BLINKS

This indicates the Battery cannot be charged. Unplug the Charger and check the charging receptacle. If there are any foreign objects, remove

them with a soft dry cloth. If the orange light still blinks or there are no foreign objects, there may be a problem with the battery or charger. Return to dealer for service.

③ (Fig. G) Charge the Battery pack.

- (1) Fully insert the Battery into the receptacle on the Charger until it sits securely on the end.
- (2) Charging will start automatically and will be indicated by the red charging light with beeps.
- (3) Charging time is approximately 35 minutes (90% capacity). This will vary by temperature and source voltage.
- (4) For batteries those are at low temperatures (10°C (50°F) or lower), charging time must be extended longer. When charging at low temperatures, both of the red and the orange charging light will be lit.

④ (Fig. H) When the battery pack has been recharged, the "red" lamp turns off and the "green" lamp blinks.

The "green" LED lamp(Fig. H 20) blinks slowly and a long beep sounds for approximately 2 seconds. Now, the battery has been recharged to approximately 90% of its capacity. Quick charging takes approximately 35 minutes (however, the recharging time and capacity slightly change depending on the ambient temperature and power voltage).

(Fig. I) You can use the battery pack when quick charging is complete. However, if you leave the battery pack on the charger, recharging will continue. When the battery is fully recharged (to 100% capacity), the "green" LED lamp lights up (and a long beep sounds for approximately 2 seconds).

- (1) (Fig. J) After you have recharged the battery pack, remove it from the charger.
- (2) (Fig. K) Unplug the charger power cord from the wall socket.



CAUTION

- When the battery pack is fully discharged, do not leave it for a long time without recharging. If the fully discharged battery pack is removed from the system and left for a long time, the battery pack may be

come damaged. Recharge the battery immediately when it has been discharged.

- Do not leave the battery pack on the charger. If the above is not observed, a weak current will continue to flow and the battery pack may become damaged. When recharging is complete, always remove the battery pack from the charger.

BATTERY PACK BREAKDOWNS

If the following conditions occur, bring the Battery and Charger to your dealer.

- The red charging lamp does not flash when the charger plug is inserted into main power source outlet (When the Battery pack is not inserted in the charger.)
- Neither the red charging lamp nor the orange standby lamp lights or flashes when the Battery pack is inserted in the charger.
- The orange standby lamp does not change to the red charging lamp even after more than 1 hour. (except at low temperatures)
- The red charging lamp does not change from constant to flashing light even after more than 90 minutes.

SERVICE LIFE OF BATTERY PACK

If any condition described below is observed, the battery pack is at the end of its service life. Replace it with a new one.

- Although the battery pack has been properly charged (fully charged), a great drop in operating time has been noticed.



WARNING

Charge the battery pack when the motor's rotational speed slows down (the Capacity of the battery pack is considered to be nearly run out). Using the tool more will cause it to over-discharge, resulting in a shortened service life of the battery pack and also in functional trouble of the tool's main body.



CAUTION

Do not use a battery pack when its service life is finished.

This will cause functional trouble in the tool's main body. Also charging a battery pack that is out of service life will lead to functional trouble in the battery charger.

RECYCLING A LI-ION BATTERY

The MAX battery pack uses a Li-ion battery, it may be illegal to dispose of this battery into the municipal waste system. Check with your local solid waste officials for details in your area for recycling options or proper disposal.



CAUTION

When disposing of the battery pack, make sure to put a pack cap on its terminal (with insulating tape securing it) to prevent short circuits.

INDICATION OF QUICK CHARGER LAMPS

Charger LED lamp	Buzzer sound	Recharging status	
Red lamp blinks. It blinks every second. ■ ■ ■	The power cord is plugged into the receptacle. Two short beeps (Pi, pi)	The charger is powered.	The charger power cord is plugged into a wall socket.
Red lamp lights. It remains lit. ■	The battery pack is mounted. One short beep (Pi)	The battery is being recharged.	Quick recharging continues.
The green lamp blinks. It blinks every second. ■ ■ ■	The battery has been recharged. A long beep for approx. 2 seconds (Piii...)	The battery has been recharged.	The battery has been recharged to approx. 90% of its capacity. If you leave the battery pack on the charger, recharging will continue.
The green lamp lights up. It remains lit. ■	Fully recharged. A long beep for approx. 2 seconds (Piii...)	Battery is "fully" recharged.	Recharged to 100% capacity.
The red lamp lights up. The orange lamp lights up. They remain lit. ■■■	—	Protective charging	The battery is recharged with a low current to protect the charger and battery.
The orange lamp lights up. It remains lit. ■	—	Standby	If the temperature of the battery pack is too high: Battery recharging starts automatically when the temperature drops below the limit. If the temperature of the battery pack is too low: Place the battery pack in a room temperature location for a while, then retry recharging it.
The orange lamp blinks. It blinks quickly (0.1 sec ON and 0.1 sec OFF). ●●●●●●●●●●	Not possible to recharge. Short continuous beeps for approx. 10 seconds (Pi, pi, pi, pi,...)	Not possible to recharge.	Unable to recharge the battery. The battery pack slot is contaminated, or the battery pack has failed.

* For batteries those are at low temperatures (10°C (50°F) or lower), charging time must be extended longer.

For the JC928 lithium ion battery charger (CE)

"Power Supply Cord: Use UL Listed and CSA Certified detachable power supply cord, 18 AWG, two conductors, cord rated VW-1, 105°C, cord external length minimum 1.8m.

One end terminates in a molded-on attachment plug with a 15 A, 125 V (NEMA 1-15P) or 15 A, 250 V (NEMA 2-15P) type configuration.

Other end terminates in a molded-on connector which mates with the Power Appliance Inlet.

If a flexible power supply cord is required, the appropriate cord (see below) must be used.

The SP-2, SPE-2, SV, SVE, or SVT flexible power supply cord can be used."

5. OPERATING INSTRUCTIONS

1. HOW TO MOUNT / REMOVE THE BATTERY PACK



WARNING

- Before mounting / removing the Battery pack from the tool, press the Safety lock switch as shown in the Fig.P, and keep hands away from the Trigger switch(Fig.Q).
- Before operation, make sure to check the Battery pack is securely set in the tool. Failure to do so may cause serious injury.

- ① (Fig. M) When mounting the Battery pack, insert the Battery pack in the tool so that the rails of the Battery and the tool fit each other. Slide the Battery pack to the end, until the click is heard. The Latches(Fig. M 16) must be returned to the original position.
- ② (Fig. E) When removing the Battery pack, remove it from the tool by pushing on its latches (Fig. E 16) from both sides while firmly holding the grip of the tool.

2. HOW TO CUT THE MATERIAL



WARNING

- Keep hands away from moving parts.
- When you cut rebar short, the cut piece may be thrown, therefore make sure the area around you is safe before cutting the rebar.
- If oil or grease gets on the grip, wipe it off completely.
If oil or grease is left on the grip, your hand may slip and the tool will fall.



CAUTION

- Insert the rebar (Fig.S 28) between the blades until it touches the bottom (Fig.S 29) and cut the rebar.
- If the trigger is left engaged after operation, the Cutter Rod restarts after cutting

through the rebar. Therefore, release the trigger after cutting the rebar.

- ① Loosen the lock nut with the included wrench. (Fig.A 11)
- ② Use the adjusting bolt so that the rebar is set at a right angle to the tool. (Fig.A 10)
- ③ Tighten the lock nut with the wrench.
- ④ Insert the rebar (Fig.S 25) to be cut between the blades. (Fig.S 26)
- ⑤ Set the rebar at the position you want to cut, pull the trigger and operate the Cutter Rod (Fig.S 27). Keep the trigger pulled until cutting is complete. The Cutter Rod automatically returns to the start position when the Cutter Rod cuts the rebar and arrives at the stroke end.
- ⑥ Release the switch to remove the rod bar.

3. HOW TO USE THE VALVE BOLT



CAUTION

- Do not turn the Valve Bolt more than necessary. Excessive turning may cause oil to leak or parts to go missing.
- ① To withdraw the Cutter Rod halfway through cutting, loosen the Valve Bolt. (Fig. T)
Loosening the bolt by about one turn in the counterclockwise direction (Fig.T 30) with a coin or screwdriver returns the Cutter Rod to the start position.
 - ② To resume cutting, securely tighten the bolt in the clockwise direction (Fig.T 31). If the bolt is loose, the rebar cannot be cut.

4. ROTATION MECHANISM OF THE HEAD



WARNING

- When turning the head, keep your fingers off the trigger. The Cutter Rod may operate, causing injury or accident. (Fig.Q)
- ① The head can be rotated by 360° (Fig.U)

5. HOW TO CHANGE THE BLADES



CAUTION

- To change the blades, be sure to remove the battery from the tool.
 - Use due caution when handling the blades because they are sharp.
 - Pay attention to the direction in which the blades are installed. (Fig.W)
 - Securely tighten the hexagon bolts that lock the blade in place. (Fig. V)
- ① Loosen the hexagon bolts (2 for each blade) that lock the blade in place with the hexagon wrench #4 and remove the old blade.
 - ② Set the new blade as shown in the Fig. W and securely tighten the hexagon bolts.

6. MAINTENANCE



WARNING

- Before inspecting the tool, make sure that the Battery pack is not set in the tool. Failure to do so may cause serious injury.
 - Before inspecting the Battery charger JC928, make sure that the Charger is disconnected from the power supply.
- ① Regularly inspect the tool
In order to maintain the performance of the tool, periodically clean up and inspect the tool.
Examine the screws regularly to make sure they are securely tightened.
Incomplete tightening may result in an accident or breakage. If a screw is loose, retighten it completely.
 - ② Do not lubricate the equipment
Absolutely do not lubricate this equipment. Applying lubrication will remove the grease inside of the tool, and cause problem on the tool.
 - ③ Do not soak the tool to any liquids. Do not put any liquid except the specified oil in the tool.

7. STORAGE

Do not store the tool in a cold weather environment. Keep the tool in a warm area.
When not in use, the tool should be stored in a warm and dry place. Keep out of reach of children. All quality tools will eventually require servicing or replacement of parts because of wear from normal use.

STORE THE TOOL

When you have finished using the tool or when the tool will not be used for a while, remove the battery pack from the tool. Tool, attachments and accessories should be stored in a well-ventilated dry place where the temperature will not exceed 40°C (104°F) and not become less than -20°C (-4°F).

The battery pack, with a pack cap installed on the pack's terminal to prevent short circuits, should be stored in a well-ventilated dry place where the temperature will not exceed 30°C (86°F) and not become less than -20°C (-4°F).



CAUTION

WHEN STORING THE BATTERY PACK FOR A LONGER TIME THAN 6 MONTHS WITHOUT USE, TO KEEP THE PERFORMANCE OF THE BATTERY PACK, FOLLOW THESE INSTRUCTIONS ;

- Fully recharge before storage.
- Put a Pack cap on the Battery pack's terminal to prevent short circuits.
- Store the Battery pack in a well-ventilated dry place where the temperature will not be less than -20°C(-4°F) and will not exceed 30°C (86°F).
- Do not store the Battery pack in a place where is under direct sunshine.