



[Click Here To View](#)
[Item at](#)

www.GapPower.com

*Sales • Rentals
Parts & Service*

Operator's Instruction Manual

Models CPU-10FC



**Gasoline and Electric
Self-propelled Concrete/Asphalt Scarifier**



100 Thomas Johnson Drive, Frederick, MD 21702-4600 USA
Phone (301) 663-1600 • 1-800-638-3326
Fax (301) 663-1607 • 1-800-447-3326
Website: www.edcoinc.com • Email: sales@edcoinc.com

Printed in USA
rvw ©2005

READ AND UNDERSTAND THE OPERATORS INSTRUCTION MANUAL *THOROUGHLY* BEFORE ATTEMPTING TO OPERATE THIS EQUIPMENT.



Death or serious injury could occur if this machine is used improperly.



SAFETY MESSAGES

- Safety Instructions are preceded by a graphic alert symbol of DANGER, WARNING, or CAUTION.



Indicates an imminent hazard which, if not avoided, will result in death or serious injury.



Indicates an imminent hazard which, if not avoided, can result in death or serious injury.



Indicates hazards which, if not avoided, could result in serious injury and or damage to the equipment.

GASOLINE/PROPANE POWERED EQUIPMENT



- Engine exhaust from this product contains chemicals known to the State of California to cause cancer, birth defects or other reproductive harm.



- Gasoline is extremely flammable and poisonous. It should only be dispensed in well ventilated areas, and with a cool engine.

- Small gasoline engines produce high concentrations of carbon monoxide (CO) example: a 5 HP 4 cycle engine operation in an enclosed 100,000 cu. ft. area with only one change of air per hour is capable of providing deadly concentrations of CO in less than fifteen minutes. Five changes of air in the same area will produce noxious fumes in less than 30 minutes. Gasoline or propane powered equipment should not be used in enclosed or partially enclosed areas. Symptoms of CO poisoning include, headache, nausea, weakness, dizziness, visual problems and loss of consciousness. If symptoms occur - get into fresh air and seek medical attention immediately.

ELECTRICAL POWERED EQUIPMENT



Extreme care must be taken when operating electric models with water present: Ensure power cord is properly grounded, is attached to a Ground-Fault-Interrupter (GFI) outlet, and is undamaged.

- Check all electrical cables - be sure connections are tight and cable is continuous and in good condition. Be sure cable is correctly rated for both the operating current and voltage of this equipment.
- Improper connection of the equipment-grounding conductor can result in a risk of electric shock. Check with qualified electrician or service person if there is any doubt as to whether the outlet is properly grounded. Adhere to **all** local codes and ordinances.
- **NOTE:** In the event of a malfunction or breakdown, grounding provides a path of least resistance for the electric current to dissipate. The motor is equipped with a grounded plug and must be connected to an outlet that is properly installed and properly grounded. DO NOT modify the plug provided on the motor. If the plug does not fit the outlet have a qualified electrician install the proper receptacle.
- Switch motor OFF **before** disconnecting power.

- Do not disconnect power by pulling cord. To disconnect, grasp the plug, not the cord.
- Unplug power cord at the machine when not in use and before servicing.

GENERAL INSTRUCTIONS

- Equipment should only be operated by trained personnel in good physical condition and mental health (not fatigued). The operator and maintenance personnel must be physically able to handle the bulk weight and power of this equipment.
- This is a one person tool. Maintain a safe operating distance to other personnel. It is the **operators' responsibility** to keep other people (workers, pedestrians, bystanders, etc.) away during operation. Block off the work area in all directions with roping, safety netting, etc. for a safe distance. Failure to do so may result in others being injured by flying debris or exposing them to harmful dust and noise.
- This equipment is intended for commercial use only.
- For the operator's safety and the safety of others, always keep all guards in place during operation.
- Never let equipment run unattended.



- Personal Protection Equipment and proper safety attire must be worn when operating this machinery. The operator must wear approved safety equipment appropriate for the job such as hard hat and safety shoes when conditions require. Hearing protection **MUST** be used (operational noise levels of this equipment may exceed 90db). Eye protection **MUST** be worn at all times.



Keep body parts and loose clothing away from moving parts. Failure to do so could result in dismemberment or death.

- Do not modify the machine.
- Stop motor/engine when adjusting or servicing this equipment.



Maintain a safe operating distance from flammable materials. Sparks from the cutting-action of this machine can ignite flammable materials or vapors.

DUST WARNING



Some dust created by power sanding, sawing, grinding, drilling, and other construction activities contains chemicals known to cause cancer, birth defects, or other reproductive harm. Some examples of these chemicals are:

- Lead from lead-based paints, and
 - Crystalline silica from bricks and concrete and other masonry products.
- Your risk of exposure to these chemicals varies depending on how often you do this type of work. To reduce your risk: work in a well ventilated area, use a dust control system, such as an industrial-style vacuum, and wear approved personal safety equipment, such as a dust/particle respirator designed to filter out microscopic particles.

Equipment Instruction Manual EDCO Model CPU-10FC

Table of Contents

<u>Section</u>	<u>Page Number</u>
What to Expect	4
Safety Guidelines.....	5
Operation Instructions.....	6-11
Maintenance Instructions.....	12-13
Silica Dust Warning.....	14
Maintenance Schedule.....	15
Limited Equipment Warranty.....	back cover

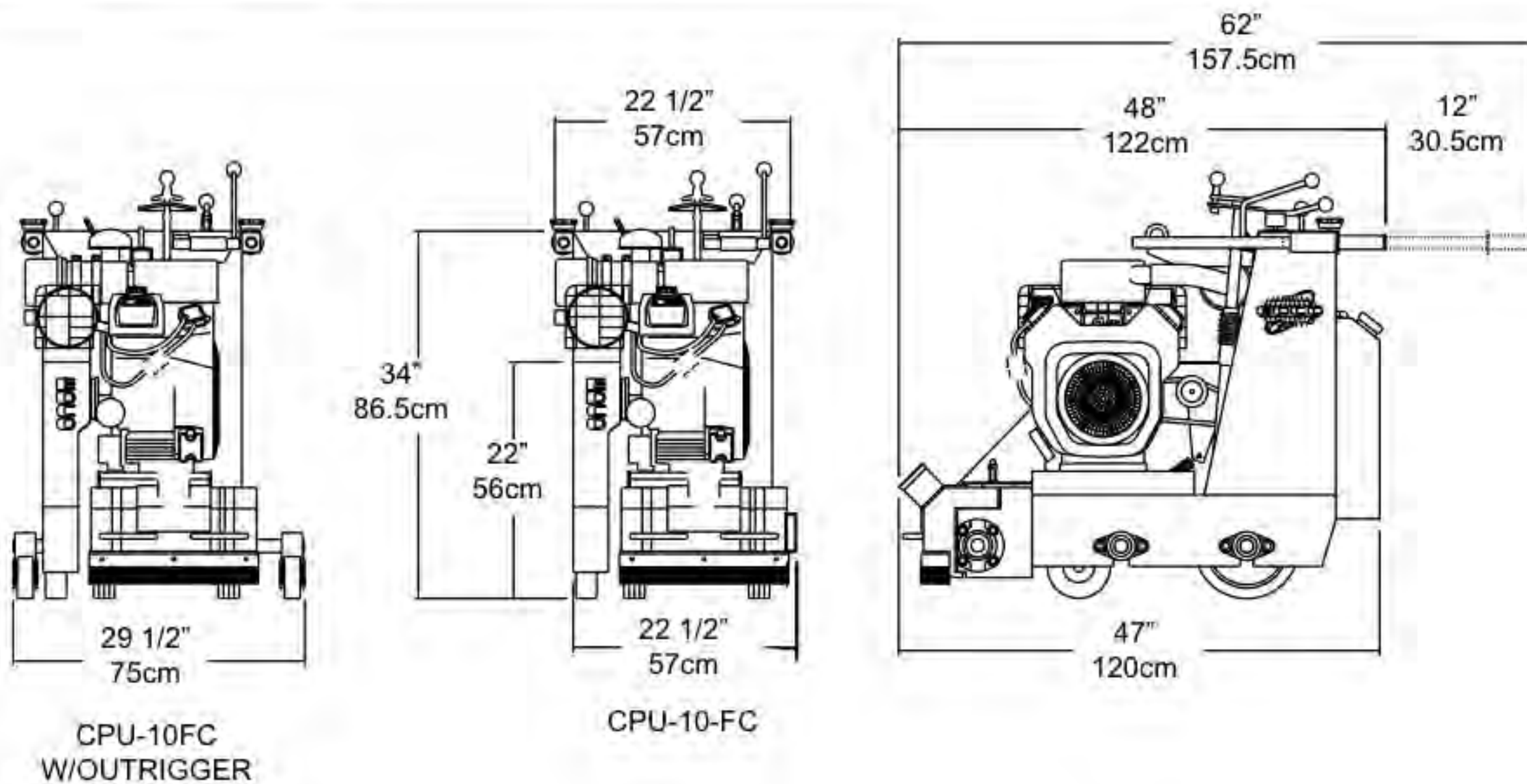

Figure 1

HOW TO ORDER REPAIR PARTS

To insure product safety and reliability, always use genuine EDCO replacement parts when making repairs to the equipment.

When ordering parts, please specify the MODEL and SERIAL NUMBER of the machine as given on the NAMEPLATE. In addition, give part number, description and quantity as listed on the parts list.

Please note: Due to improvements and changes in the equipment the illustrations shown may be different from the actual machine.

Toll Free: Voice 1-800-638-3326 • Fax 1-800-447-3326

Specifications and dimensions are approximate and subject to change.

Model	CPU-10FC
Length	47"/120cm
Width	22 1/2"/57cm
Height	34"/86.5cm
Weight	530lbs/240kg



100 Thomas Johnson Drive, Frederick, MD 21702-4600 USA
 Phone (301) 663-1600 • 1-800-638-3326
 Fax (301) 663-1607 • 1-800-447-3326
 Website: www.edcoinc.com • Email: sales@edcoinc.com

What to Expect from your CPU-10FC EDCO Concrete Scarifier

The CPU-10FC EDCO concrete scarifier was designed to remove material from the surface of concrete slabs. The material may consist of excess concrete, coatings, contaminants such as industrial debris, sealer, paint, production line spill and virtually any foreign substance that creates a safety or health hazard on walks, passageways or floor surfaces.

The EDCO scarifiers are primarily used for surface preparation in commercial and industrial buildings. The machine's total weight is an advantage when used on upper floors where lbs per sq. feet is an important factor. We have kept the overall width to 22 1/2" (57 cm), with outrigger 30" (76.2cm) to allow for passage through most commercial doorways.

Since the maximum depth of cut is 1/2" (2 cm) in increments of 1/8" to 3/16", it is not suited for removal of very hard concrete such as the kind found on roads, bridge decks or runways. This work is best accomplished by heavy duty milling machines built for that purpose.

The basic mechanical structure consists of a fabricated steel frame, a power source - electric or gasoline and a rotating drum like cutter head that can be raised or lowered to a chosen depth by the operator.

The CPU-10FC model is designed with an "up-cut" rotation of the cutter drum assembly, consequently a milling type action occurs which is more efficient than the "down-cut" found on the manual units.

The self propelled units require very little manual labor to operate - a single lever controls speed, forward and reverse directions. Note that it will cut in forward or reverse directions.

The 10 inch wide drum assembly consists of a welded cage holding 4 or 6 hardened shafts - locked in place during operation and removable when replacing cutters.

Several styles and sizes of cutter are available. All types of cutters may be used on both sizes of drum assemblies. Cutters vary in size - 2 3/8" for light removal, 3" diameter for longer life. Additional cutter wheel specifications can be found on literature and price lists.

The efficiency of the scarifier is determined by 3 factors - the hardness and type of surface to be removed, the type of cutting tool and the power behind the cutters.

Since the hardness of the surface cannot be changed and the cutter type is limited to present state of the art material and the power source is fixed - there may be conditions that are beyond the capability of the scarifier. To exceed these limits will only cause problems. Cutter life will be shortened drastically, excessive vibration will most likely cause the scarifier to self destruct.

EDCO cannot accept responsibility if the conditions found on the job site exceed the ability of the equipment to meet the contractors expectations. It is the obligation of the purchaser, user or renter to determine the compatibility of the scarifier with the job to be performed.

We at EDCO are prepared to assist the user. We can provide technical information and comparison data on jobs of a similar nature. Given information on the project we can advise the contractor which tools, in our opinion, will suit the job best, approximate production rates and possibly arrange a demonstration or suggest an alternative method or equipment.

EDCO concrete scarifiers, when properly used, will perform efficiently and economically, but as with all "demolition" equipment, unless proper maintenance is provided they tend to wear out faster than other mechanical devices.

It is important that each job be considered individually. Testing should be carried out and a determination made if the project is feasible under the circumstances. In those instances where no other alternative is available, various changes in procedure can be tried - shallower cutting depth, slower forward speeds, spacing of cutters changed - extra weight added. We do not guarantee life of cutters, depth of cut, life of equipment (except for workmanship). Equipment of this type is capable of self destruction through misuse or abuse and the owner/operator is the vital component that can mean success or failure of the project.

Our technical information has been obtained from years of experience on all types of job sites and we gladly share this information with you. New materials are constantly being introduced - concrete is made harder with additives, chemicals and new curing techniques. We try to keep up with these changes, it's a never ending job for us and we need your cooperation to provide us with accurate job site conditions and information.





Read and understand the *Operator's Manual*,
and the *Engine Manufacturer's Owner's Manual*
before operating this equipment.



Death or serious injury can result if this machine is used improperly.



Safety Guidelines



Eye and ear protection must be worn at all times when this machine is in use. During normal use, sound levels exceed 92dB. Use only ANSI approved safety glasses to help prevent eye injury. Everyday eyeglasses have only impact resistant lenses; they are NOT safety glasses.



Operator must wear appropriate clothing and footwear. Do not wear loose clothing or jewelry that can get tangled or caught in moving parts. Steel toe safety shoes should be worn.

- Maintain the machine in safe operating condition with all guards in place and secure, all mechanical fasteners tight, all controls in working order and the machine configured for the job application. Be sure all safety decals can be clearly read and understood. Replace damaged or missing decals immediately.
- The CPU-10FC Scarifier is designed to plane flat, horizontal concrete or asphalt slabs. Scarifiers maybe equipped with gasoline, propane or electric motors. They are designed to be operated by a single operator from a position at the rear of the equipment.
- Keep a safe operating distance to other personnel in the area and never leave the machine running unattended.
- Avoid deck inserts, pipes, columns, openings, electrical outlets, or any objects protruding from slab surface.
- Never operate this machine while under the influence of drugs, alcohol or when taking medications that impair the senses or reactions, or when excessively tired or under stress.
- Avoid touching or handling accessories after use, they are hot and can cause burns.



For Electric Models:

Electrical motor must be properly grounded at all times. Check the outlet box to be sure the electrical service is properly grounded. Be sure adequate power is available. Insufficient power will cause motor to overheat and burn out. Use only grounded extension cords correctly sized for the current draw and voltage drop (amp rating and length). Never use frayed, damaged, taped or underrated extension cords. Electrical shock could result in death or serious injury to the operator and damage to the equipment.



For Gasoline Models:

Poisonous exhaust gas. Do not operate gasoline powered equipment without adequate ventilation. Carbon monoxide is an invisible, odorless gas that can kill. **NEVER REFUEL A HOT ENGINE OR AN ENGINE WHILE IT IS RUNNING.** Only refuel a cool "stopped" engine and in a well-ventilated area. Properly clean any spilled fuel before starting the engine.

Safety warnings and guidelines do not by themselves eliminate danger.
They are not given as substitutes for proper accident prevention and good judgement.



100 Thomas Johnson Drive, Frederick, MD 21702-4600 USA
Phone (301) 663-1600 • 1-800-638-3326
Fax (301) 663-1607 • 1-800-447-3326
Website: www.edcoinc.com • Email: sales@edcoinc.com

Printed in USA
TYW ©2005

Page 5

Operating Instructions

- | | |
|-----------------------------------------|-----------------------------------------------------------------------------|
| 1. Cutter Head Lever | 7. Choke Control |
| 2. Clutch Lever | 8. Drive Control Lever |
| 3. Depth Control Knob | 9. Handle Locking Knobs |
| 4. Lifting Eye | 10. Hour Meter |
| 5. Ignition Switch (Position will vary) | 11. Water Hook Up |
| 6. Throttle Control | 12. Fuel Lockoff Solenoid Toggle
For Propane Models Only.
(Not Shown) |

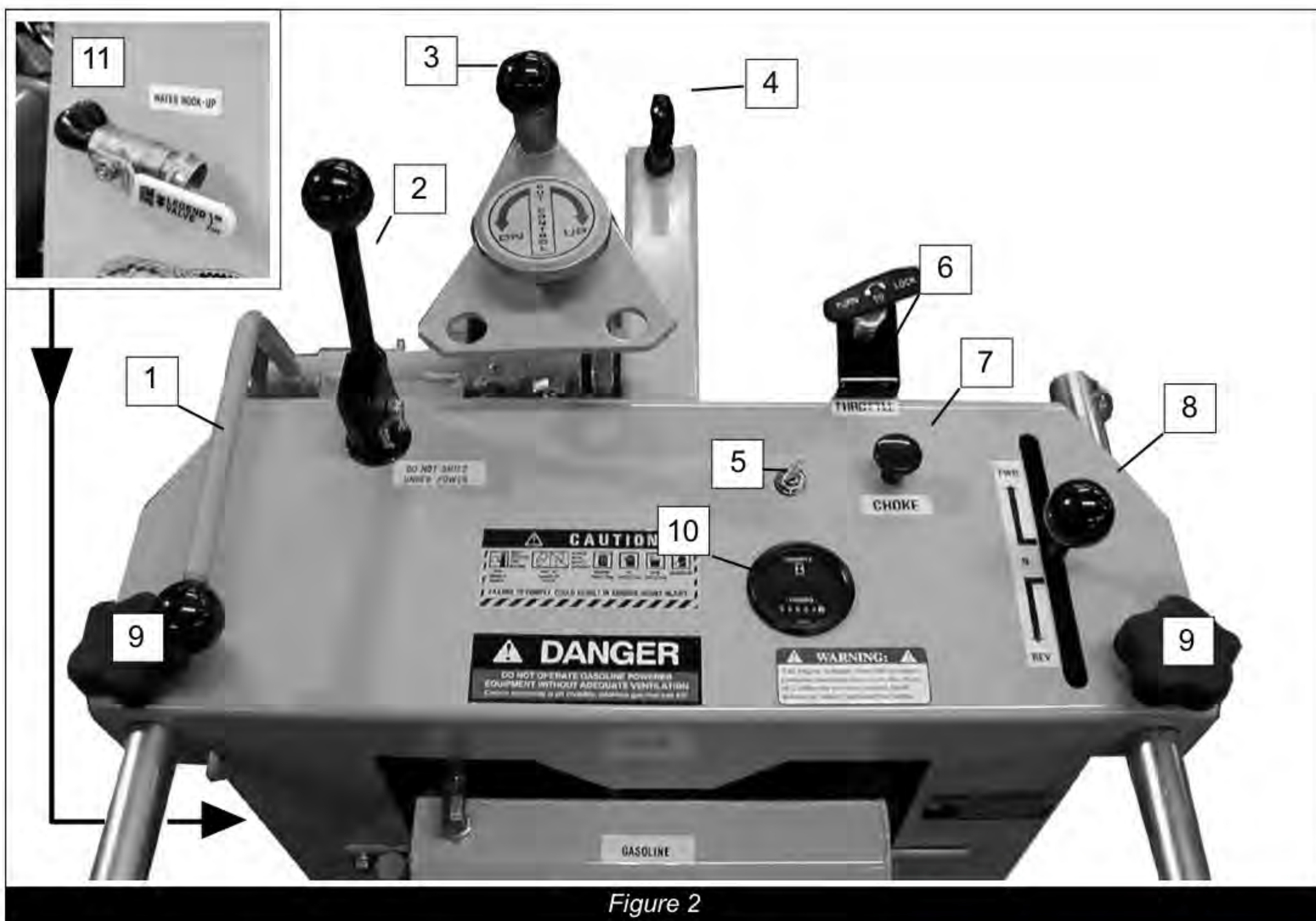

Figure 2

Before Starting the Machine:

- Perform a visual inspection of the entire machine and all daily maintenance according to the *Maintenance Schedule* on page 15.
- Locate and be familiar with all engine/motor and operating controls (*Figures 2*).
- For Gasoline models, obtain the *Engine Manufacturer's Owner's Manual*. Read it and understand it before continuing. Follow the engine manual for break-in instructions.
- Use the correct cutters for the job. Be sure cutter drum is balanced, the number, size and type of cutter wheels are correct and the cutter drum shaft is locked and secured.
- Be sure all fasteners are tight and secure, check for signs of metal cracking or fatigue, inspect for damage to electrical wiring, damage to fuel lines, check bearings, etc.
- Be sure all guards are in place. Do not operate unless cutter drum guard is in place and secure.
- Inspect work area to determine the presence and location of deck inserts, pipes, columns and objects protruding from the slab surface so that they may be avoided during operation.
- Adjust the handles for operator comfort and safe operation. Be sure to retighten knobs. (Figure 2, Item 9)
- Raise the cutter head to the full "up" position using the cutter head lever on the console. (Figure 2, item 1)
- Move the machine into operating position by disengaging the clutch (Figure 2, item 2). Lower clutch lever when unit is in position.



DO NOT disengage clutch when engine is running and cutter drum is in contact with slab surfaces. Failure to comply could result in serious bodily injury and/or damage to the equipment.

Starting the Engine/Motor:

For Electric Models:

- Be sure the "OFF" button is depressed on the motor starter box.
- Hook up the correct voltage/phase electrical power source by plugging into the connector provided. If the cord does not mate with the connector, consult a qualified licensed electrician before continuing.
- Verify that the electrical current being supplied is the proper voltage and phase required to run the equipment
- Check motor rotation. Cutter drum rotation on the model CPU-10FC is "upcut." DO NOT use if drum rotation is incorrect - have a qualified electrician make the necessary change in the main control panel or motor connection box.

For Gasoline Models:

- Consult the *Engine Manufacturer's Owner's Manual* and follow the directions for starting the engine and allow the engine to warm up.



Starting the Cut:

- Crank Depth Control up.
- Slowly lower the cutter head to the slab surface with the cutter head lever. (Figure 2, Item 1)
- Lift the knob of the Depth Control to unlock and turn the hand wheel slowly until the cutter head contacts the slab (you will hear the sound of the cutter wheels contacting the slab). Continue adjusting the depth of cut until the desired depth is reached; max depth of cut 3/8" (9.5 mm).
- Use an Industrial Vacuum Dust Control System for dry planing operations.

Forward/Reverse Ground Speed Control:

- The drive control lever (Figure 2, Item 8) provides variable ground speed in both forward or reverse directions. The lever is spring loaded and returns to neutral when released. Ground speed is increased by moving the lever forward away from the neutral position. Depth of cut and hardness of material will determine the most efficient cutting speed. Deep cutting requires slower forward speeds, allow engine to run at full RPM during the cutting operation.

To Stop Cutting:

- Move drive control lever to neutral, raise cutter head assembly above slab surface.
- For gasoline models, close throttle and turn the ignition switch to the "off" position.
- For electric models, depress the "OFF" button.

After Cutting:

- At the end of the day, clean the entire machine after it has cooled. Check for worn or damaged cutters and perform any required maintenance. See Maintenance Schedule and Instructions on page 13.

Transporting:

- Before hoisting, always inspect frame and attachment hardware for damage. Use proper and safe hoisting techniques and approved hardware. CPU-10FC weight is approximately 530 lbs (240 kg).

CAUTION

Never hoist a machine over top of where people are working or standing. Never hoist a machine while the engine is running. Serious person injury or damage to the equipment can result.

Cutting Heads / Drums:

- Drum assembly revolves at approximately 2000 R. P. M.; Model CPU-10FC is an "up-cut" planer. Depth of cut is completely determined by the material to be cut, horsepower of the engine and spacing of the cutter wheels on the cutter head.
- All cuts should be started from a stationary position - when the cutting depth is reached the plane should then move forward.
- The engine should not labor. Run at full throttle and adjust forward speed to fit the work being performed. Very hard concrete will have to be cut at a slower pace than asphalt or deteriorated surfaces.
- If it is necessary to make deep cuts - make several shallow cuts to achieve the desired depth. If the cutting depth is set too deep the cutter wheels will not be able to absorb the shock and damage to the equipment will result.
- The cutter wheels have an oversized arbor hole. This "play" is needed to absorb some of the shock of the cutter contacting the concrete.
- Cutting speed is directly proportional to the amount of material to be removed in one pass; an example - cutters spaced on 1" centers will penetrate to a greater depth than those spaced at 1/2" centers, and the planer will move forward faster. Most of the material in the path of the cutting head will be removed either by the cutters themselves or through the natural hammering action and spalling of the material being cut. A later pass with cutters spaced closer together will remove the ridges.

To Reach Maximum Depth in Concrete:

- It is best to make several passes - increments of 1/8" or even less if surface is extremely hard.
- Use coarse (wide spacing) for initial passes. Complete job with medium spacing. Never use a fine spaced cutter head to cut deeper than 1/8".
- Some concrete slabs, especially if they are covered with water a good deal of time or if they have been treated with hardeners, develop an extremely high surface strength.
- Material removal depth should not exceed 1/8" per pass thus requiring several passes to reach the desired depth of cut.

To Cut Asphalt:

- This surface is usually easy to penetrate - depths of 1/4" can be reached using medium spacing. Let the job guide your selection of cutter spacing. Deep cuts require wide cutter spacing. Asphalt will usually break out between cutters and a fairly uniform clean cut is the result.

Note: Specific information on asphalt cutting is available upon request.

Fine Cutting:

- This assembly should be used for very shallow or cleaning operations. Check with dealer for special cutter wheels for removal of paint build-up or similar surface coatings.



100 Thomas Johnson Drive, Frederick, MD 21702-4600 USA
 Phone (301) 663-1600 • 1-800-638-3326
 Fax (301) 663-1607 • 1-800-447-3326
 Website: www.edcoinc.com • Email: sales@edcoinc.com

Printed in USA
 rww ©2005

Traffic Line Removal:

- For this operation, be sure to set depth of cut to just penetrate the paint. Most state and municipal agencies require 70% to 80% removal. If the road surface was pitted (worn or just old and full or uneven areas when it was painted), it will be impossible to remove the paint from the depressions without changing the depth setting.
- We suggest leaving these areas to be completed last after the majority of the lines have been removed. Return to the problem spots, reset the depth and proceed to remove the paint. This procedure will minimize the time necessary to do the job and will prevent cutting into the road surface.
- The EDCO CPU-10FC model is ideally suited to remove thermoplastic lines - the upcut feature removes the plastic from the surface by "milling" or lifting. In excessively hot weather it may be necessary to sweep the plastic away from in front of the planer - hot plastic tends to build up on the tires changing the cutting depth setting.
- To keep thermoplastic from heating up, we recommend to spray water on the work surface whenever possible.

Note: If the CPU-10FC will be used for traffic line removal, the optional front outrigger wheel assembly will follow the contour of the surface to be cut. By doing this you can control the amount of surface to be removed with little or no damage beneath the paint.

**Refer to the *CPU-10FC Assembly Instructions* booklet
for suggested Cutter Drum setups.**







Cutter Wheels Use only EDCO approved cutter wheels. Cutter wheels for all application are available - sizes and types vary. Complete information is available from EDCO.	
<p><u>Hi Carbon Cutters:</u></p>  <p>CP-404: 2-3/8" diameter - 1" ID x 3/16" max. depth of cut - 1/2" - hi-carbon cutters - use on concrete 3500 PSI or less.</p>  <p>CP-404P: Same as above, except teeth are pointed to aid in removal of paint or similar surface material - points wear and become flat. When this happens, use as you would standard CP-404.</p>  <p>CP-405: 3" diameter - 1" ID x 3/16" - max. depth 3/4" - hi-carbon steel cutters - use on concrete 3500 PSI or less.</p>  <p>CP-405P: Same as above, except teeth are pointed to aid in removal of paint or similar surface material - points wear and become flat. When this happens, use as you would standard CP-405.</p>	<p><u>Tungsten Carbide Cutters:</u></p>  <p>CP-404TV: 2-1/8" OD x 1" ID x 1/4" thk 6 point, tungsten carbide inserts. Use for long life and fast removal of concrete, asphalt or coatings.</p>  <p>CP-408TV: 3-1/8" OD x 1 3/16" ID x 5/16" thk 8 tungsten carbide inserts. Heavy duty cutter with oversized inner diameter. Maximum cutter shaft diameter 1". Heavy removal of concrete, asphalt or coatings.</p> <p><u>Spacers:</u></p>  <p>CP-403: Hardened steel spacers for use with all cutter wheel set ups.</p>

Figure 4

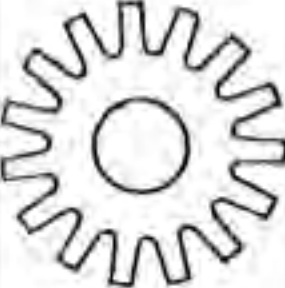

Outrigger Wheel Assembly: (Optional)

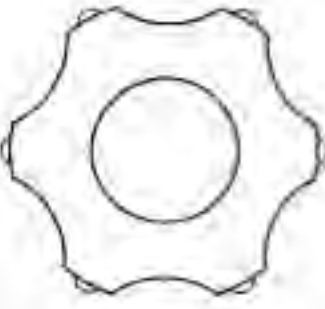
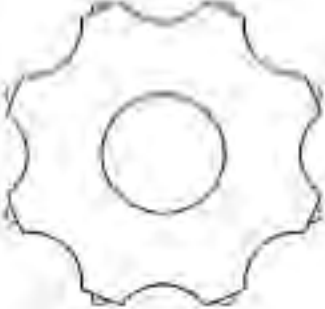
Outrigger wheel assembly (Figure 5) is designed to allow the drum to follow the contour of the slab. Wheels are aligned with cutting drum to follow highs and lows of the slab removing a consistent depth over the entire surface. Can be used with all accessories but highly recommended for diamonds and heavy duty roto peen, removing traffic lines or thin coatings.

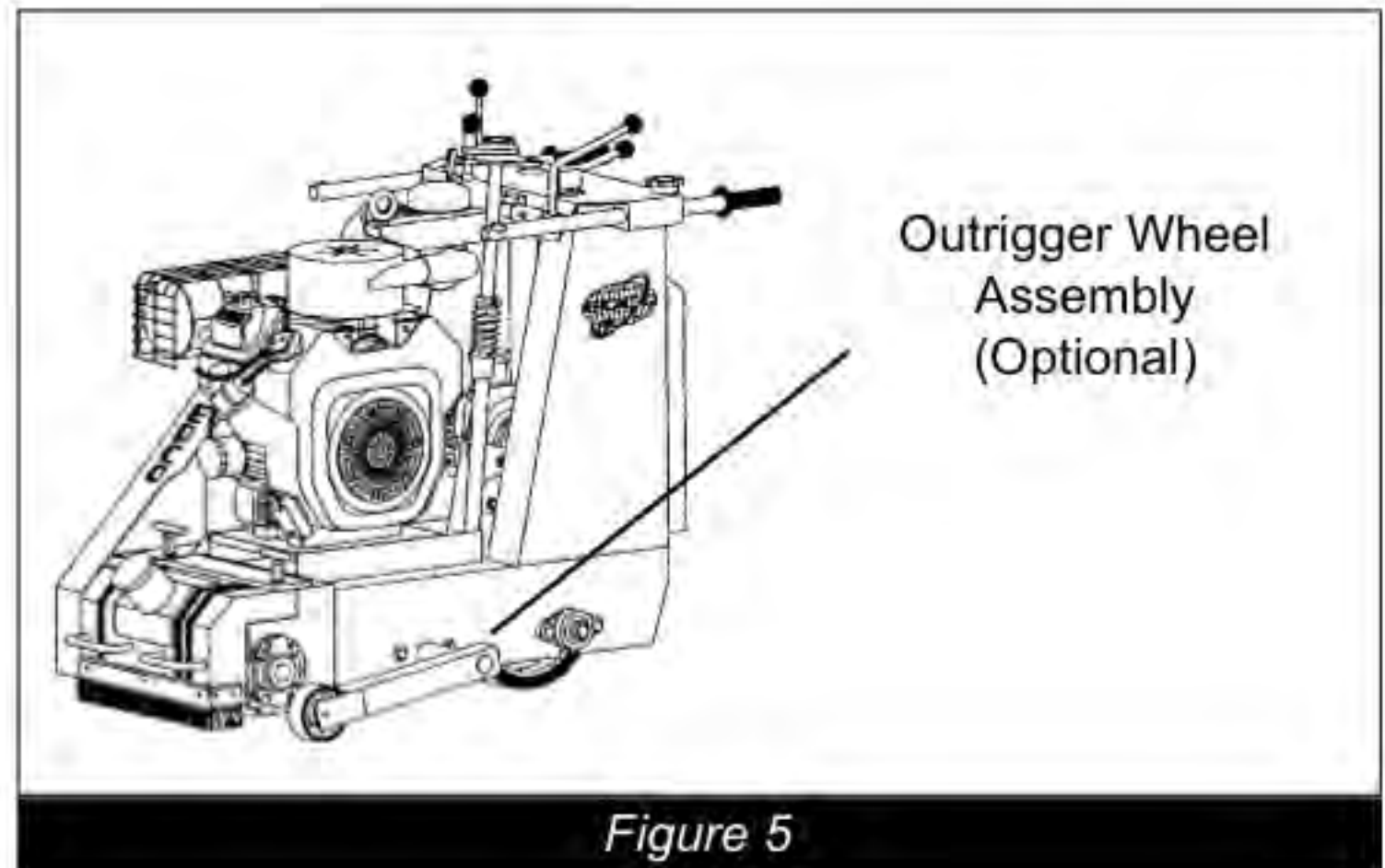

Figure 5

Do Not Bottom Cutter Assembly

If front wheels are not in contact with slab surface when planing you are bottoming the cutter head. You are riding on the drum & cutter wheels. Cutter wheels will wear uneven or break if this is continued. (Figure 6)

Re-adjust depth - turn fine adjustment in "up" direction until cutters are free and cutting is being accomplished by "hammering" action only.

Failure to follow these instructions will cause undue cutter wear, breakage, bearing failure or excessive vibration that will be transmitted back to the machine frame and engine eventually causing a virtual self-destruction of the unit.

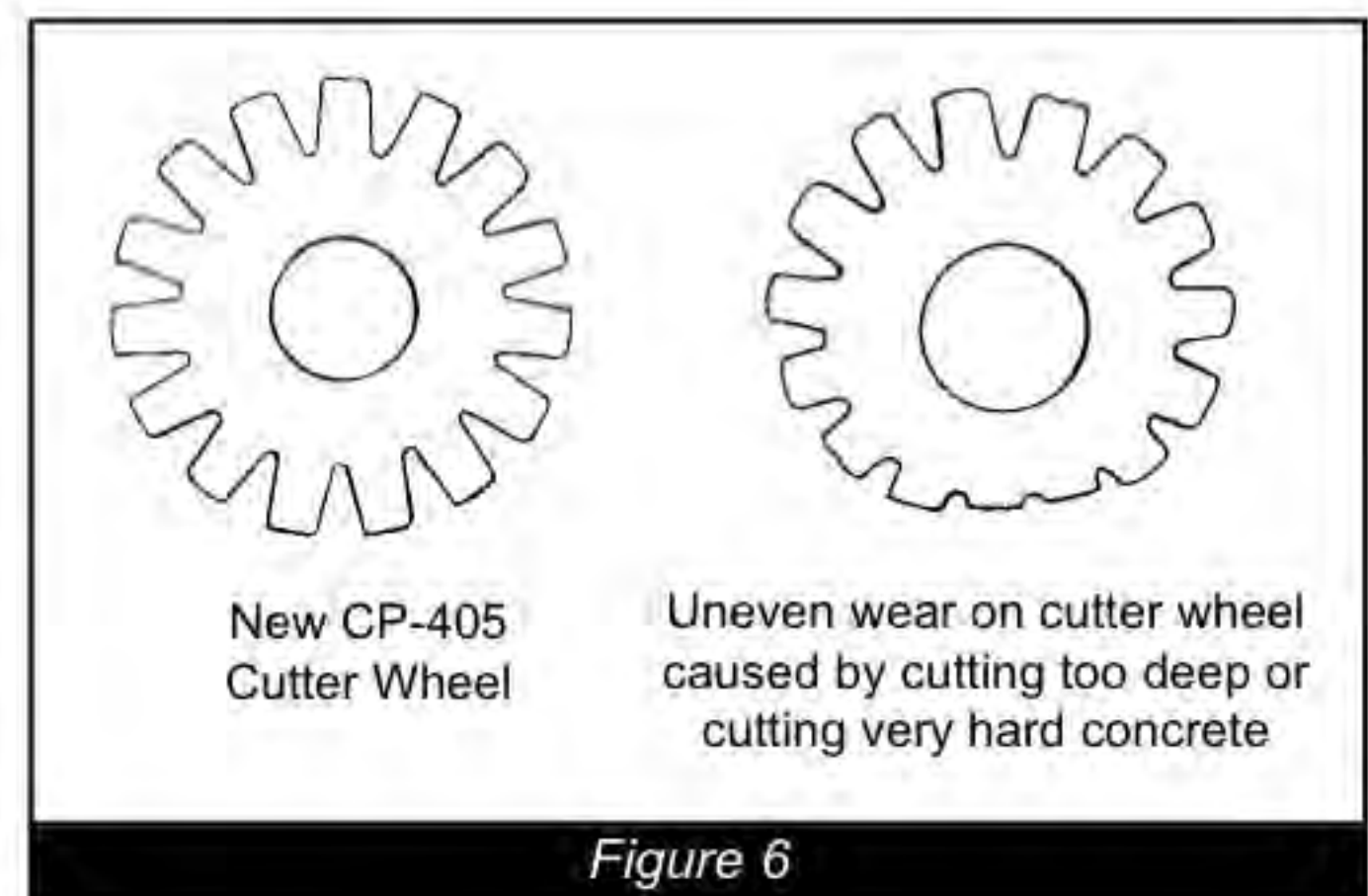

Figure 6

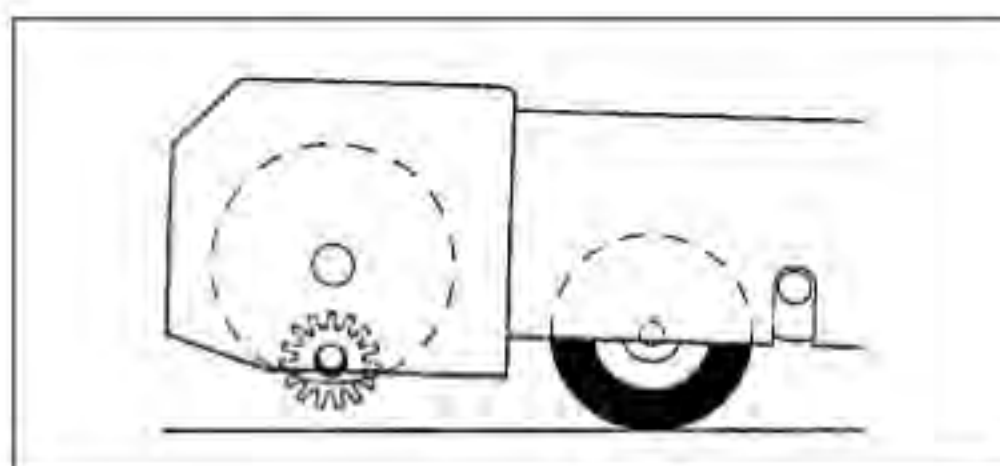

Figure 7a

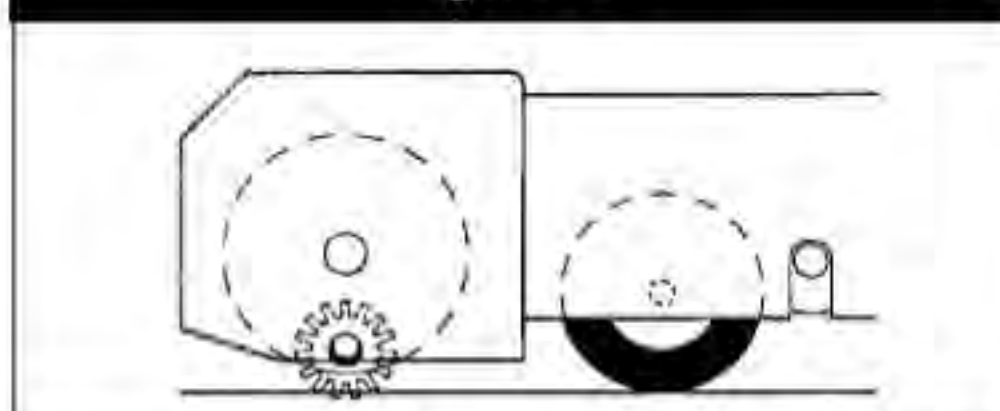

Figure 7b

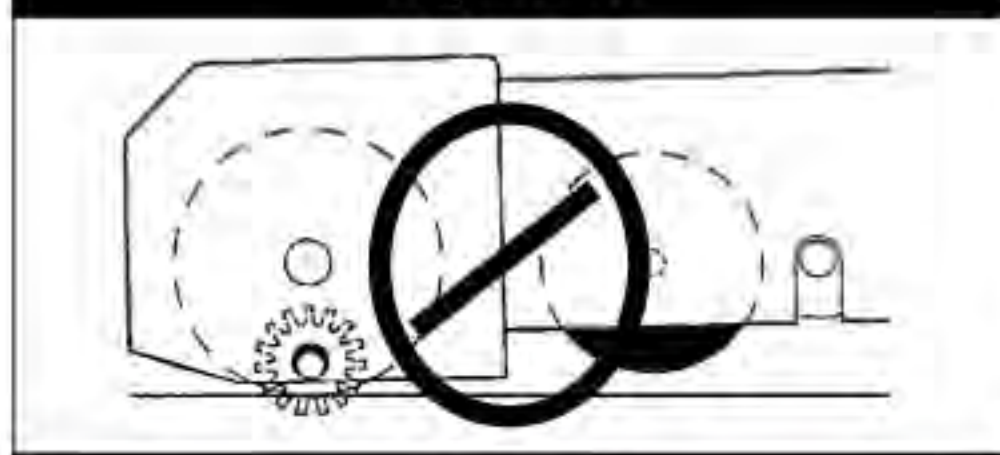

Figure 7c

"Full Up Position"

Cutter wheels raised from surface for preparation in starting engine or to stop cutting operation. (Figure 7a)

"Pre-selected Depth"

Depth of cut determined by the hardness of the surface. Cutter wheels should swing free on shaft. (Figure 7b)

"Bottomed Out"

This can cause severe damage to equipment or cause cutters to flatten or break. (Figure 7c)

Cutter wheels are jammed or forced up against shaft by trying to remove too much in one pass. Wheels are raised from the surface and front rides on the drum flanges.



Remove both spark plug leads on gasoline engine models or disconnect the supply voltage connector on electric models before performing any maintenance. Disconnect the power cord at the machine.



Maintenance Instructions

Refer to the Engine Manufacturer's Owner's Manual for maintenance information specific to the engine used.



Never work on or under equipment without first securing the equipment to prevent it from moving or falling. Always work on a flat and level surface.



IMPORTANT!

Grease cutter assembly bearings (2) after every 4 hours of use.

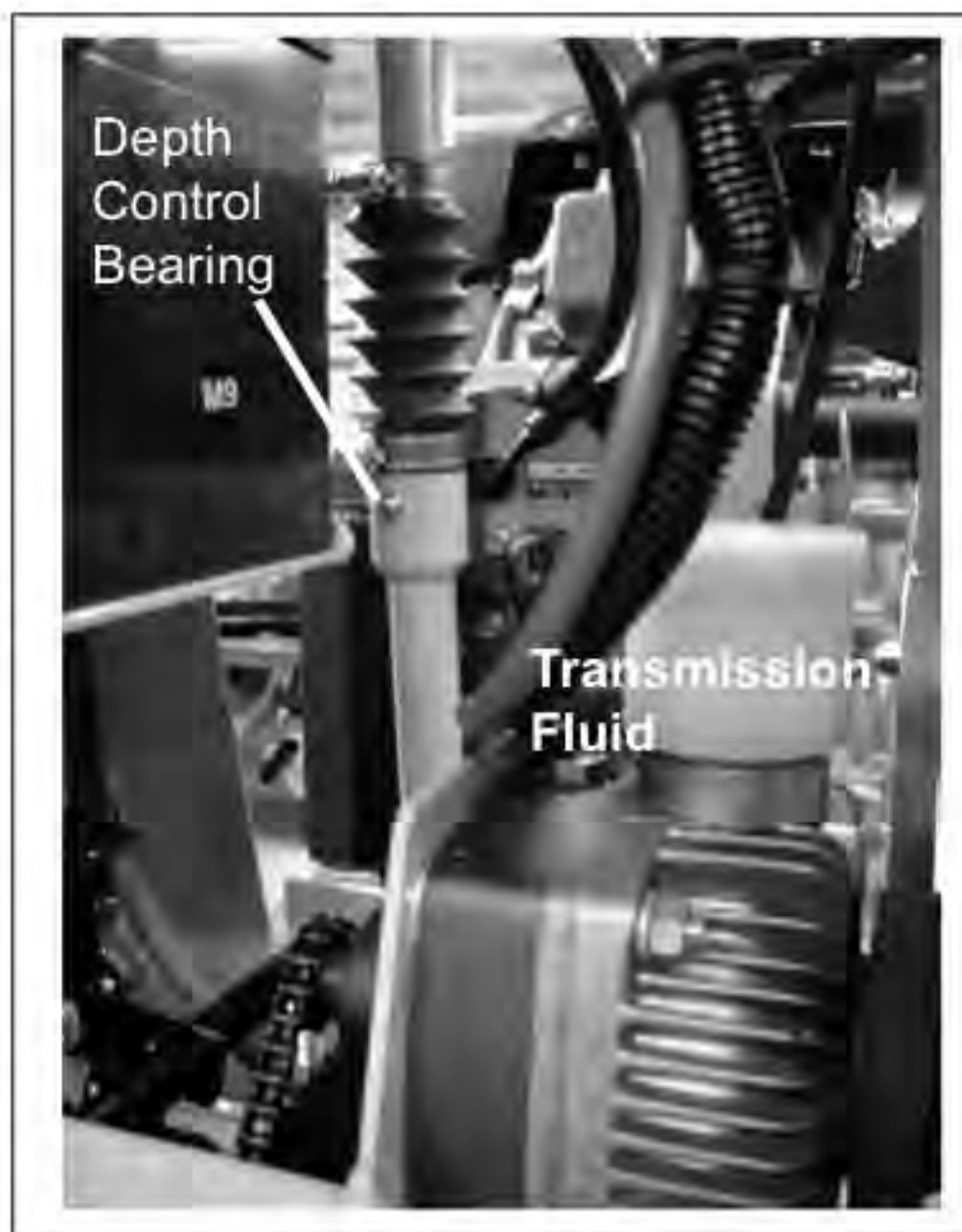

- Grease Depth Control Bearing every 40 hours.
- Check hydrostatic transmission fluid level after every 50 hours of operation. If it is low, fill to level mark with GM Dexron B or comparable fluid.



Important!

- Check oil level before operation. Change engine oil and filter according to engine manufacturers recommendations.
- Clean air filter element daily.

Belts:

- On new equipment, and after replacing a set of belts, they should be re-tensioned after the first four hours of use.
- New belts will be stiff and will loosen with use. Proper belt tension must be maintained to transmit the engine power to the cutting drum. Slipping belts will overheat, the blade life will be shortened and the cutting speed limited. Over tensioned belts will shorten the belt and bearing life.
- Damaged, stretched or excessively worn belts should be replaced with a new matched set.
- To tension belts, loosen motor mounting hardware slightly. Use the jacking bolt to adjust the motor until the belts are tight. Re-torque the engine mounting hardware.



Jacking Bolt and Engine Mounting Hardware



Belts



Silica Dust Warning**WARNING**

Grinding/cutting/drilling of masonry, concrete, metal and other materials can generate dust, mists and fumes containing chemicals known to cause serious or fatal injury or illness, such as respiratory disease, cancer, birth defects or other reproductive harm. If you are unfamiliar with the risks associated with the particular process and/or material being cut or the composition of the tool being used, review the material safety data sheets and/or consult your employer, the manufacturers/suppliers, governmental agencies such as OSHA and NIOSH and other sources on hazardous materials. California and some other authorities, for instance, have published lists of substances known to cause cancer, reproductive toxicity, or other harmful effects.

Control dust, mist and fumes at the source where possible. In this regard use good work practices and follow the recommendations of the manufacturers/suppliers, OSHA/NIOSH, and occupational and trade associations. Water should be used for dust suppression when wet grinding/cutting/drilling is feasible. When the hazards from inhalation of dust, mists and fumes cannot be eliminated, the operator and any bystanders should always wear a respirator approved by NIOSH/MSHA for the material being used.

WARNING

Grinding/cutting/drilling of masonry, concrete and other materials with silica in their composition may give off dust or mists containing crystalline silica. Silica is a basic component of sand, quartz, brick clay, granite and numerous other minerals and rocks. Repeated and/or substantial inhalation of airborne crystalline silica can cause serious or fatal respiratory diseases, including silicosis. In addition, California and some other authorities have listed respirable crystalline silica as a substance known to cause cancer. When grinding/cutting/drilling such materials, always follow the respiratory precautions mentioned above.

Maintenance Schedule



Repairs are to be done by authorized EDCO Dealers only.



Read and follow instructions in the engine owner's manual.

All maintenance to be performed by qualified personnel.	Before Operation	Every 4 Hours	Daily	Every 40-50 Hours of Operation	As Required
Visual Inspection of Entire Machine	X				
Check Engine Oil*	X				
Cutter Shaft Wear (bushings, drum)	X				
Grease Cutter Assembly Bearings		X			
Clean Air Filter Element*			X		
Clean Dust & Dirt Off Machine			X		
Check Hydrostatic Transmission Fluid Level				X	
Change Engine Oil* (Refer to engine manual)				X	
Grease Wheel Bearings				X	
Belt Tensioning					X

* Gasoline and propane models only.



100 Thomas Johnson Drive, Frederick, MD 21702-4600 USA
 Phone (301) 663-1600 • 1-800-638-3326
 Fax (301) 663-1607 • 1-800-447-3326
 Website: www.edcoinc.com • Email: sales@edcoinc.com

Printed in USA
 rww ©2005

LIMITED EQUIPMENT WARRANTY

Equipment Development Company, Inc. herein referred to as EDCO warrants that each new unit manufactured by EDCO to be free from defects in material and workmanship in normal use and service for a period of (1) one year (except in the case of the cutter drum assembly on all model concrete asphalt planes, in which case the warranty period shall be 90 days) from date of shipment to the original retail or equipment rental center owner.

EDCO will, at its option, repair or replace, at the EDCO factory or at a point designated by EDCO any part, which shall appear to the satisfaction of EDCO inspection to have been defective in material or workmanship.

This warranty, does not apply to failure occurring as a result of abuse, misuse, negligent repairs, corrosion, erosion, normal wear and tear, alterations or modifications made to the product without express written consent of EDCO: or failure to follow the recommended operating practices and maintenance procedures as provided in the products operating and maintenance manuals.

This warranty does not obligate EDCO to bear any transportation charges in connection with the replacement or repair of defective parts. This warranty does not obligate EDCO to bear any expense for travel time or of personnel in connection with any service calls.

Accessories or equipment furnished and installed on the product by EDCO but manufactured by others, including but not limited to engines, motors, electrical equipment, transmissions, etc., shall carry the accessory manufacturers' own warranty.

THIS WARRANTY IS IN LIEU OF ALL OTHER WARRANTIES, EXPRESSED OR IMPLIED, OR STATUTORY, INCLUDING ANY WARRANTIES OF MERCHANTABILITY OR OF FITNESS FOR A PARTICULAR PURPOSE.

LIABILITY LIMITATIONS

The remedies of the user set forth under provisions of warranty outlined above are the exclusive and total liability of EDCO with the respect to their sale or the equipment and service furnished hereunder, in connection with the performance or breach thereof, or from the sale, delivery, installation, repair or technical direction covered by or furnished under the sale, whether based on contract, warranty, negligence, indemnity, strict liability, or otherwise shall not exceed the purchase price of the unit of equipment upon which such liability is based.

EDCO will not in any event be liable to the user, any successors in interest or any beneficiary or assignee relating to this sale for any consequential, incidental, indirect, special or punitive damages arising out of this sale or any breach thereof, or any defects on, or failure of, or malfunction of the equipment under this sale based upon loss of use, lost profits or revenue, interest, lost goodwill, work stoppage, impairment of other goods, loss by reason of shutdown or non-operation, increased expenses of operation of the equipment, cost of purchase or replacement power of claims of users or customers of the user for service interruption whether or not such loss or damage is based on contract, warranty, negligence, indemnity, strict liability, or otherwise.

EDCO reserves the right to modify, alter and improve any part or parts without incurring any obligation to replace any part or parts previously sold without such modified, altered or improved part or parts.

No person is authorized to give any other warranty or to assume any additional obligation on EDCO's behalf unless made in writing and signed by an officer of EDCO.

Equipment Development Company, Inc.

USE ONLY GENUINE EDCO PARTS AND ACCESSORIES
For your own safety, the safety of others and the life of your machine

