



**GRANITE  
INDUSTRIES**



# **ELECTRIC POWERED CARTS**

*OWNER'S MANUAL*



FOR USE WITH ALL 400 SERIES  
2WD WHEELBARROWS AND WAGONS

97022-2

## CONTENTS

CART FEATURES .....	3
FREQUENTLY ASKED QUESTIONS.....	4
CHARGING INFORMATION .....	5
OPERATING INSTRUCTIONS .....	6
OPERATING INSTRUCTIONS .....	7
USING THE HOPPER.....	8
TROUBLESHOOTING .....	9
BATTERY INFORMATION.....	10
BATTERY REPLACEMENT (24v, 24 amp) .....	11
<b>STANDARD CART INFORMATION .....</b>	<b>14</b>
CHASSIS PARTS DIAGRAM.....	15
WIRING DIAGRAM .....	18
<b>POWER DUMP CART INFORMATION .....</b>	<b>19</b>
CHASSIS PARTS DIAGRAM .....	20
WIRING DIAGRAM .....	22
ADDITIONAL REPLACEMENT PARTS.....	23

## OVERLAND CARTS GUARANTEE



All Overland Carts are designed and assembled in the USA using parts made in-house along with quality global components.



*Expect more. get more.*  
FROM GRANITE INDUSTRIES

- Exceptional quality and service on every single product.
- Professional grade designs by our in-house engineers.
- Industry leading warranties.
- Owned and operated in the USA.

To view more products from Overland Carts scan the QR code with your phone or visit [OverlandCarts.com](http://OverlandCarts.com)



## 1 YEAR WARRANTY

- **Electronics:** Includes controller, s-drive, and wiring
- **Powertrain:** Includes transaxle containing the motor and differential
- **Wheels, Casters & Tires**
- **Batteries & Charger**
- **Hoppers:** Includes Brentwood hopper, and white garden hopper

## 3 YEAR WARRANTY

- **Chassis:** Includes steel frame and powder coating

## TERMS

Warranty starts from the delivery date of the cart.

We will repair, without charge, any defect due to faulty material or workmanship. These warranties do not cover failures due to abuse, misuse, improper installation, accidental damage or when repairs or modifications have been made or attempted to be made by anyone other than Granite Industries. Any defective products that meet warranty specifications and Granite Industries approval, may be returned to the factory to be repaired or replaced free of charge. (Granite Industries will pay to ship replacement item(s) to the customer; however the customer is responsible for shipment of products to the factory.)

This remedy is the sole remedy in contract, tort or otherwise, and Granite Industries is not liable for incidental, consequential or special damages.

These warranties give you specific legal rights, and you may have other rights which vary from state to state.

Should you have any questions, contact Granite Industries at 877-447-2648. (Proof of purchase may be required).

Overland Carts are covered by one or more of the following patents:

US D752,834 S	US D752,838 S	US D779,762 S
US D752,835 S	US D752,307 S	US D779,765 S
US D752,836 S	US D752,308 S	US D781,020 S
US D752,837 S		

Overland carts are a part of the Granite Industries family. All carts are manufactured by Granite Industries in Archbold, Ohio.



**GRANITE  
INDUSTRIES**

**Customer Service**

**877-447-2648**

**M-F, 8am - 5pm EST**

# CART FEATURES

## Built with you in mind.

### Our carts come fully assembled

All Overland Carts come fully assembled, charged and ready to use. All you have to do is power the cart on and drive away. (We do recommend charging overnight after receiving.)

### Crate Disassembly Instructions:

We recommend using a hammer or crowbar to remove the portions that are nailed down.

### We designed our carts to be simple to operate:

- To turn on, pull the red On/Off switch out towards you.
- Toggle the black switch for forward and reverse.
- Grasp and twist the throttle.
- To turn the cart off, simply push the red button in.

### Safety Features

- **Emergency Stop** – The red E-Stop button allows the user to immediately stop the progress of the cart.
- **AutoLock** – Automatically locks the wheels when the throttle is not being applied. This feature prevents the cart from rolling away from the user and also provides easy loading and unloading on inclines.
- **HillSense** – Allows the cart to be used safely on inclines and declines. The cart will travel at the speed set by the user, not by the incline or decline.
- **SmoothStart** – On acceleration, power is applied to the drive tires in a controlled manner ensuring a smooth start each time.
- **Four Wheel Design** – All Overland Carts have at least four wheels to provide maximum stability.

### They've been tested (again and again)

The standard 24 amp-hr rechargeable battery packs have been extensively tested. We are confident to rate the batteries with a 6-8 hour real world capacity. The cart was tested with three different weights (0 lbs, 300 lbs, 600 lbs) and driven on both grass and pavement.



## Satisfaction Guaranteed

Granite Industries is committed to making sure each Overland Cart meets your expectations. To ensure customer satisfaction, we offer a 15 day money back guarantee. Use the cart and see how much easier the cart makes your projects. If you're not satisfied, simply contact Granite Industries at 877-447-2648 for a return authorization and details.

Orders and quote requests can be emailed to [support@graniteind.com](mailto:support@graniteind.com) or faxed to 419-445-3304

## FREQUENTLY ASKED QUESTIONS

### How long do the batteries last on a single charge?

It is completely dependent upon how much weight is being carried, the type of terrain, and the softness or hardness of the surface. We estimate a range of 6-8 hours of "real world" use. PLEASE NOTE: Most use is not as intense as our "real world" estimates, so actual use time is typically much longer. Visit [YouTube.com/OverlandCarts](https://www.youtube.com/OverlandCarts) to view videos of our product testing.

### When and how long should I charge my cart?

Charge your cart immediately after using. If, during operation, the battery indicator light goes to red, it is time to recharge. It is recommended to leave the cart on the charger overnight to extend the life of the batteries.

### How long will the batteries last before needing to be replaced?

The batteries are designed to last for 400-800 charge/discharge cycles, which translate into approximately 2-4 years. The batteries are common, and can be purchased from Granite, your local battery supplier, or on Amazon.

### Will tipping the unit hurt the batteries, electronics, or drive system?

No. Batteries, electronics, and drives can operate in any orientation.

### What is the maximum speed?

All Overland Carts operate from 0 to 3 miles per hour in both forward and reverse.

### While pushing my cart in manual/freewheel mode, it suddenly decelerates aggressively. What causes this?

There is a safety feature on your Overland Cart that is designed to prevent the cart from running away when the brake is manually disengaged.

### How much weight can my cart handle?

750 lbs is the maximum load for level ground.

### Why does my cart lose traction when one wheel is off the ground?

The drive system is an open differential that allows the machine to efficiently make turns without skidding the tires. The drawback is that if one of the drive tires leaves the ground, it will simply spin until all tires are back on the ground.

### Is a balanced load important to the performance?

Yes. Balancing the load so that it is not top-heavy or side-loaded, will allow much safer operation. Furthermore, most of the load should be located over top of the drive wheels for better traction.

### How do I clean my Overland Cart?

Simply remove all debris, hose it down with soapy water, and towel dry. We do not recommend using a pressure washer.

### Can I use my Overland Cart in cold temperatures?

You certainly can, but we recommend that you charge and store the batteries at room temperature.

### What maintenance is required?

Not much, really! Simply remember to always recharge when not in use - it's okay to leave the cart on the charger. The drive system is sealed for life, thus no lubrication is required. Also, keep the unit dry to enhance its life and appearance.

### How should I store my cart?

We recommend keeping your cart indoors, out of the rain and other elements. For long-term, or "off season" storage, give the battery an overnight charge, then disconnect the battery pack from the cart and store it indoors at room temperature. Every 3-4 months, fully charge the battery even though it's not in use. This helps to prolong the life of the batteries.

### Where is the serial number?

Every Overland Cart comes with its own serial number. This is located on the front side of the upper control box. You will need this number when you fill out your warranty card.

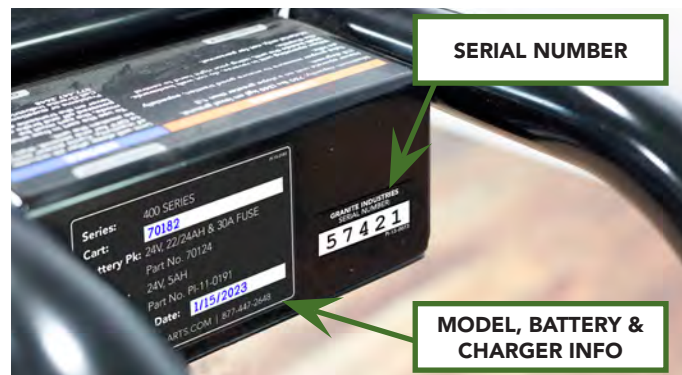

# CHARGING INFORMATION

## CHARGE YOUR CART

When your cart arrives, please plug it in and make sure the battery is fully charged. There is a battery charge display on the side of the battery pack.

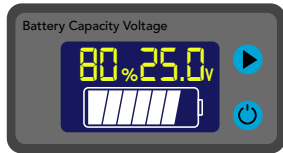

The smart charger uses a three-stage charging system to optimize battery longevity. Once the charger maximizes the charge to the batteries, it will go into standby/float mode. The charger can be left connected to the batteries after a full charge (green light) without harming the batteries.

The voltage for the battery pack will read 100% after a full charge. If not used immediately, the battery pack will slowly drop to about 90% after 24-48 hours. This is normal. If the battery pack is plugged back in, the percent will quickly go up to 100%.

For the best battery life, charge the cart after each use or at the end of the work day. It is preferable to let the batteries charge overnight by plugging the cart into a 110V outlet.

## State of Charge

The battery capacity can roughly be estimated by its voltage. As there are subtle differences in the voltage of each battery, the following parameters are for reference only. The voltage needs to be tested at rest (with zero current) after 15 minutes of being disconnected from the charger and loads.

For optimal battery life and long-term performance recharge when the battery pack reaches 40%.

The chart below shows how each individual 12V battery should perform and then also shows how two 12V batteries should perform when put into series. This is the configuration for your cart.

24 V AGM Battery Pack State of Charge		
Level	12 V Battery Voltage	24 V Battery Pack Voltage
100%	13.00 V	26.00 V
90%	12.78 V	25.55 V
80%	12.50 V	25.00 V
70%	12.30 V	24.60 V
60%	12.15 V	24.30 V
50%	12.05 V	24.10 V
40%	11.95 V	23.90 V
30%	11.81 V	23.62 V
20%	11.66 V	23.32 V
10%	11.51 V	23.02 V
0%	10.50 V	21.00 V

## Balancing Batteries

As a part of routine battery maintenance, you may want to rebalance the batteries once or twice a year. We recommend a charger like the Noco Genius GEN5X1. It charges and balances one 12V battery at a time. Each battery can be rebalanced and then put back into the battery pack. This can also be helpful if the battery pack is dropping to 90% quickly after being recharged.

## BATTERY CAUTIONS AND WARNINGS

1. Before using the battery charger, read all instructions and cautionary markings on the battery charger, batteries and the product using the batteries.
2. Only use the type of batteries that the charger is specified for. Other types of batteries may burst, causing personal injury or damage.
3. Do not expose charger to rain or snow.
4. Do not cover the charger or charge battery in an airtight enclosure. Ventilation is important to prevent overheating.
5. Make sure extension cord is not used unless absolutely necessary. Use of improper extension cord could result in

risk of fire and electric shock. If extension cord must be used, make sure:

- The pins on the plug of the extension cord are the same number, size and shape as those on the charger. (3 prong with ground)
  - The extension cord is properly wired and in good electrical condition. A 16 ga cord or heavier duty extension cord is recommended.
6. Do not operate a charger that has been dropped, damaged or has a damaged cord or plug - replace immediately if there are signs of damage!
  7. Do not disassemble the charger.

# OPERATING INSTRUCTIONS

## SAFETY INFORMATION

- Flat free semi pneumatic tires are not pressurized and do not have a valve stem.
- Only use chargers and batteries issued by Overland Carts. Use of third party batteries or chargers may cause harm to the user and the cart.
- Always make sure the hopper is latched securely before operating the cart.
- Always make sure the load is distributed evenly in the hopper and the cart is stable before operating.
- Push in the red E-Stop whenever the cart is sitting still or whenever the batteries are charging.
- Do not exceed the rated capacity of 750 pounds for the cart on flat surfaces.
- Exercise caution when operating on inclines or declines.
- Do not drive the cart over sudden drops such as curbs, steps, or ledges. We recommend using ramps to navigate uneven surfaces.
- The metal battery pack can be opened to reveal the batteries; however, the physical batteries should never be opened. They are sealed lead acid batteries and cannot be resealed. Do not attempt to add more battery acid or water. If the batteries need replaced, please purchase new batteries.

## BEST PRACTICES

- Hand wash your Overland Cart with soapy water. Never use a pressure washer.
- Do not drive your cart through deep puddles of water and do not submerge the drive system or battery box.
- The drive system is lubricated for life, so no maintenance is required.
- When the battery indicator light goes to red, it is time to recharge.
- Recharge cart immediately after using.

## POWER YOUR CART ON

To power your cart on, pull the red E-stop button out. You will notice the battery indicator lights light up, and your cart is ready for operation.

If the Overland Cart sits inactive for 20 minutes while on, it will go to sleep in order to conserve power. To wake the cart up, push the E-Stop button in, and pull it back out to power your cart on again.

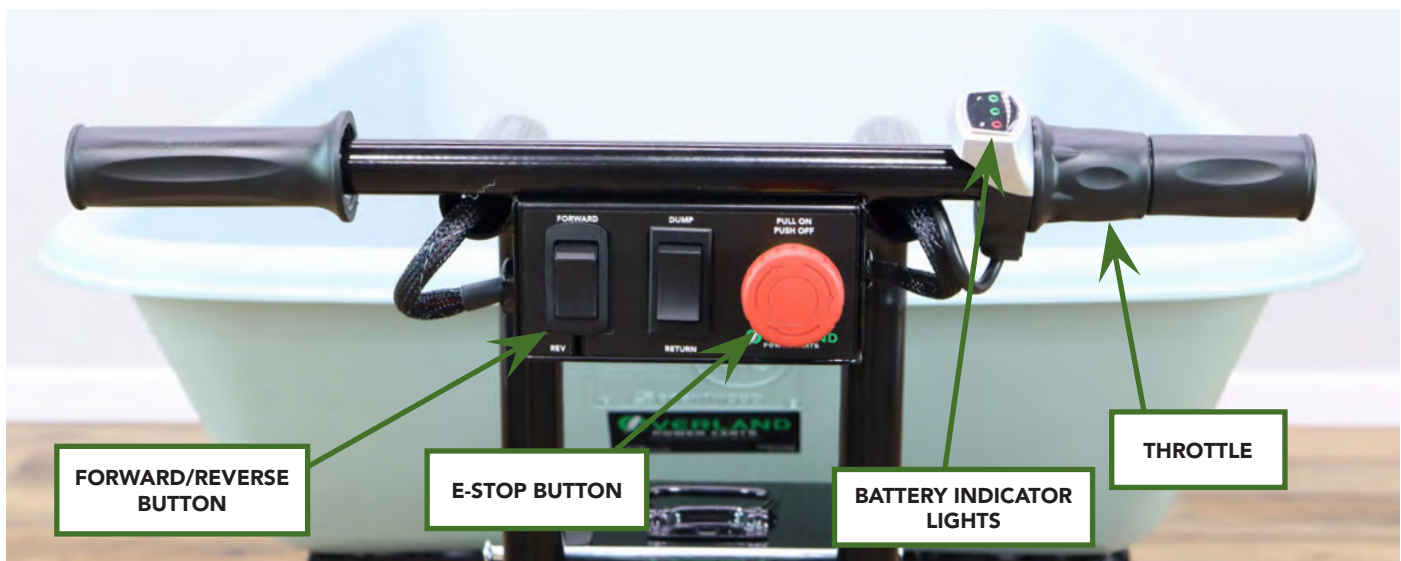

# OPERATING INSTRUCTIONS

## DRIVING YOUR CART

Once your cart is on, make sure your forward/reverse button is toggled upwards for forward. Twist the throttle towards you and the cart will begin moving forward. While driving your Overland Cart forward, stay directly behind the cart with both hands on the handles. When operating the cart in reverse, do NOT stand in the path of the cart and walk backwards. Instead, turn around and stand beside the unit to prevent accidental injury.



**FORWARD OPERATION**



**REVERSE OPERATION**

## SLOPES AND INCLINES

When going downhill, operate your cart in reverse, leading the cart downhill with the handles first. This will prevent your cart from tipping over, especially if it is carrying a full load. Do not drive your cart across an incline, this may cause the cart to roll over on it's side. Always travel parallel with the slope or incline.

## FREE WHEEL MODE

The drive system is equipped with a lever that overrides the electromechanical brake for manually operating your Overland Cart. The brake lever allows you to override the electric brake when you need to push the cart manually, when loss of power had occurred. With the brake in the disengaged position, the E-Stop button must be pushed in, and the power turned off, or the drive system will not move freely. The controller will NOT operate the motor when the brake is disengaged.

When lever is in the up position the brake is engaged, and when down it is disengaged. When you reset the brake system the unit will not operate until you toggle the power button off and back on, this process will need to be repeated every time the brake is manually disengaged.

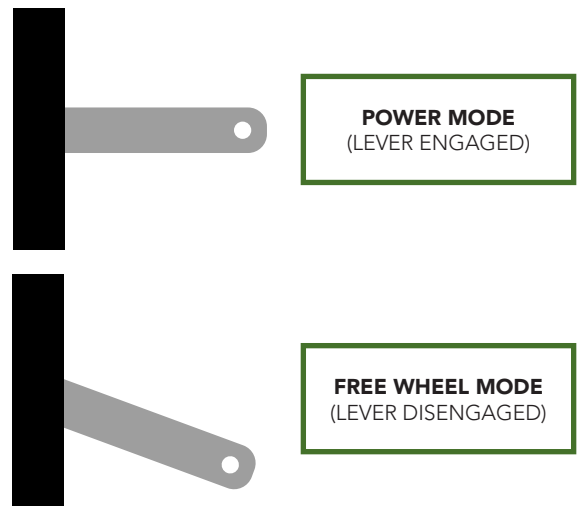

## USING THE HOPPER

Before loading the hopper, make sure the g-pin is latched in place, locking the hopper to the cart.

There are multiple ways to dump the hoppers:

### TIPPING THE ENTIRE CART

With the hopper locked to the cart frame, push the handlebars upward and forward, causing the entire cart to dump. The wheels will stay locked in place.

**NOTE:** If your cart is in freewheel mode, the wheels will NOT lock in place and the cart will roll forward.

### DUMPING THE HOPPER ONLY

Disengage the g-pin, located on the right side of the cart. This unlocks the hopper from the cart frame. Lift the hopper up and forward to dump the contents. Lock back in place when finished.



### POWERED DUMP (NOT AVAILABLE ON ALL MODELS)

Some models are equipped with a power dump feature. This option allows you to dump the cart with the push of a button. The Power Dump button is located in the center of the control panel, between the forward/reverse button and the E-Stop.

For a controlled dump, make sure the hopper is locked to the cart frame with the g-pin located at the back of the hopper.

Push and hold the rocker button in the up position. To return

the hopper, push and hold the rocker button in the down position.

For a quick release dump, unlock the g-pin and follow the previous steps. When the load reaches a tipping point, the hopper will quickly fall forward, emptying its contents.



Power dump feature



Quick release feature on the power dump cart



# TROUBLESHOOTING

Issue	Possible Problem	Solution
Cart will not run	Batteries are dead	Charge the Overland Cart
	E-Stop is in the OFF position	Pull e-stop out, to the ON position
	Unit is in sleep mode	Cycle the unit OFF for a couple seconds, then back ON
	Cart is in freewheel mode (brake is disengaged)	Re-engage motor brake (see free wheel mode section)
	Electrical malfunction	Disconnect and connect all electrical connections, and make sure they are all secure
	Moisture issue	Let dry, avoid getting the s-drive and battery box wet
Cart shuts off during use	Circuit breaker has tripped	Push the reset button on the battery pack (see diagram below)
	Thermal overload (weight, climb angle, or terrain may have exceeded transaxle capacity)	Release throttle, allow transaxle to cool down at least 30 seconds. Unload some weight, cycle power switch and operate machine again. Reset button will likely need to be pushed
Cart suddenly stops	Broken or loose motor wire or connector	Check motor wires and brake wires to make sure none are broken, and also check connector to make sure wires are secure
Cart abruptly slows down while in freewheel mode	Safety feature has triggered preventing the cart from rolling away	Push the cart slower while in freewheel mode
Batteries are not lasting as long as desired	Cold batteries	Keep batteries warm
	Batteries not fully charged	Make sure your cart is fully charged before using
	Batteries are damaged or too old	Replace your batteries
	Loose wire connections	Check all connections to make sure everything is secure
Charger light goes directly to green when charging, but battery is not charged	The battery and/or charger may have gone bad	Test the charger on another battery if possible. Replace battery and/or charger
	The connections may have come loose, or disconnected	Check charger and battery connections

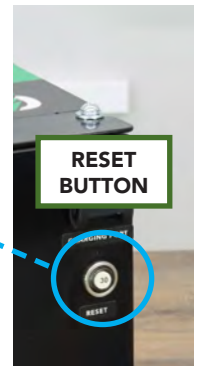

# BATTERY INFORMATION

## IMPORTANT RECOMMENDATIONS

- It is recommended to wear insulated gloves when handling batteries.
- If equipment is to be stored for a long period of time, the batteries should be disconnected to avoid undue drain.
- When replacing your batteries, fasten them tightly, but do not apply undue force to the terminals, or bend them.
- Do not place batteries in close proximity to objects which can produce sparks or flames.
- Avoid exposing batteries to heat.
- Do not mix batteries with different capacities, different ages or different makes.
- For best results and generally acceptable performance and longevity, keep operating temperature range between 5° F (-15° C) and 122° F (50° C)
- It is good practice to ensure that the connections are re-torqued and the batteries are cleaned periodically.
- Do not attempt to disassemble batteries. Contact with sulfuric acid may cause harm. If it should occur, wash skin and clothing with liberal amounts of water.
- Batteries should not be stored in a discharged state or at elevated temperatures.
- Please recycle old batteries. Do not throw them away, or attempt to burn them. Attempting to burn batteries (new or old) may cause them rupture or explode.

## BATTERY FEATURES

- Absorbent Glass Mat (AGM) technology for superior performance.
  - AGM design ensures the acid inside the battery is spill-proof
  - Vibration resistant
  - Better performance in cold temperatures
  - Faster charging
  - Longer expected life
- Valve regulated, spill proof construction allows safe operation in any position. However upside down is not recommended.
- Maintenance free design. There is no need to add electrolyte, as gases generated during the charge phase are recombined in a unique oxygen cycle.
- Power/volume ratio yielding unrivaled energy density.
- Special separators, advanced plate composition and a carefully balanced electrolyte system ensure the battery has the ability to recover from an excessively deep discharge.
- All batteries feature a series of low pressure, one-way relief valves. These valves safely release any excessive accumulation of gas inside the battery and then reseal themselves.
- Batteries may be discharged over a temperature range of 5° F (-15° C) and 122° F (50° C), and charged at temperatures ranging from -5° F (-15° C) and 104° F (40° C). For best results we recommend charging the batteries at room temperature.
- The case materials impart great resistance to shock, vibration, chemicals and heat.
- U.L. recognized under file number MH 14533.
- ISO 9001/14001/18001 Certified

# BATTERY REPLACEMENT (24v, 24 amp)

## TOOLS

#2 or #3 Phillips screwdriver

**NOTE:** FOR 24V 22 AMP BATTERY PACK  
USE 8MM SOCKET & WRENCH



# 1

Disconnect the wires going to the battery box. Remove the battery from the cart by taking out the hair pin and removing the rod. Slide the battery box out from its housing.



# 2

Remove the four (4) #10 screws holding the lid in place. Remove the lid and set aside.



# 3

Carefully remove the batteries, and disconnect the nut & bolt connectors. PLEASE RECYCLE YOUR OLD BATTERIES



New handle mount battery location



Old under mount battery location

## BATTERY REPLACEMENT (24v, 24 amp)

# 4

Reconnect the batteries to the power connector, circuit breaker and charging port as shown below. Do not actually remove the power connector, charging port and breaker from the battery box. They are shown this way below for a better visual.

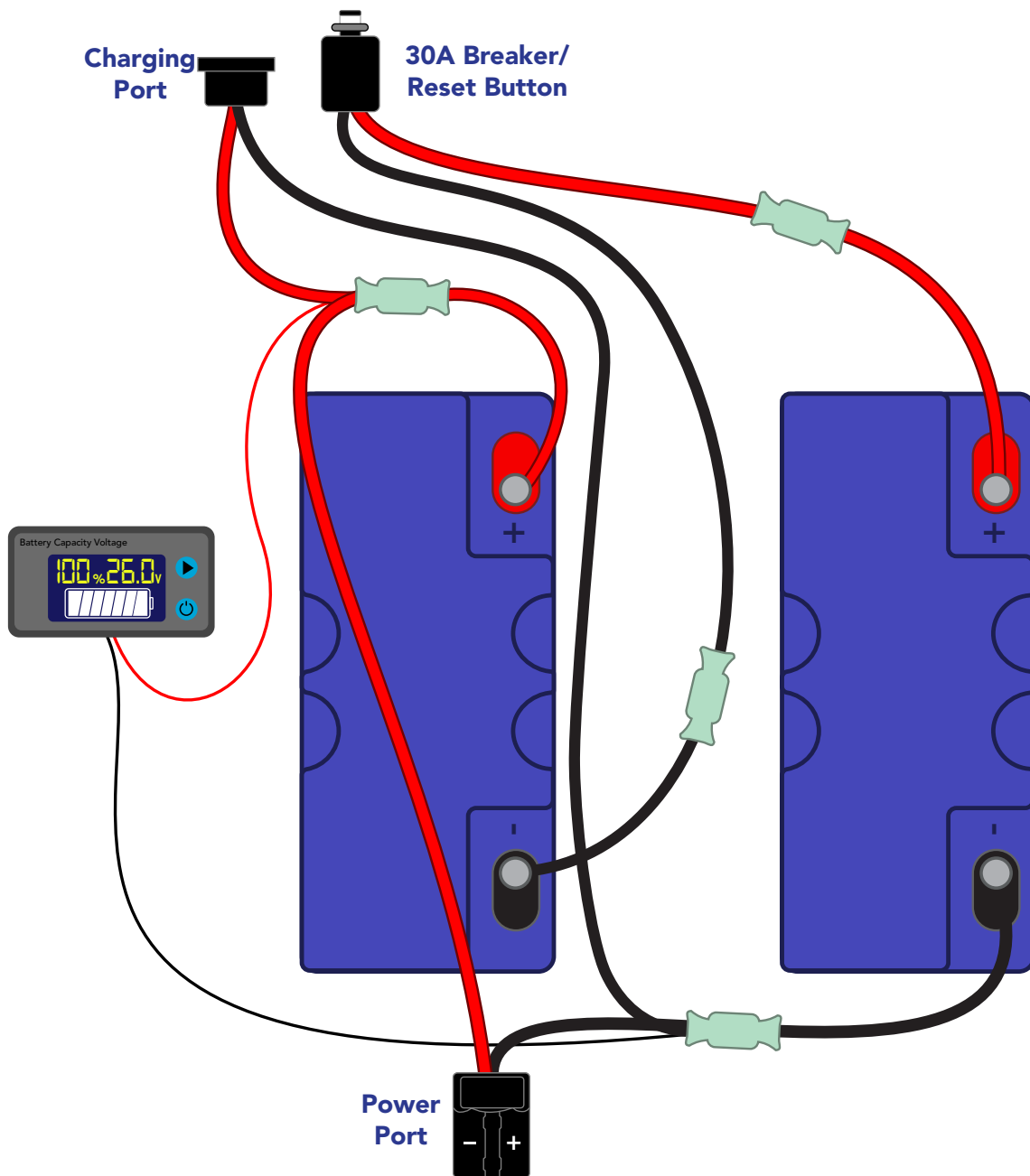

## BATTERY REPLACEMENT (24v, 24 amp)

# 5

Place the batteries back into the box one at a time. Make sure the **terminals are opposite** each other. Tuck the wires into the box and out of the way.



# 6

Replace the box lid and secure with four (4) #10 screws.



# 7

Place the battery box back onto the cart, insert the rod and secure with the hair pin. Reconnect the wires to the power terminal. Charge overnight before use.

## STANDARD CARTS

The following pages contain information that relates to the below carts. Although the hopper styles may be different, the parts, chassis and wiring is all the same.



**8 Cu Ft Wheelbarrow with**  
 13" Flat Free Dual Ag Tires (70186)  
 13" Flat Free Single Ag Tires (70071)  
 13" Flat Free Turf Tires (70285)



**10 Cu Ft Wheelbarrow with**  
 13" Flat Free Dual Ag Tires (70182)  
 13" Flat Free Single Ag Tires (70078)  
 13" Flat Free Turf Tires (70286)



**7 Cu Ft Residential Wheelbarrow with**  
 13" Flat Free Turf Tires (70289)  
**6 Cu Ft Residential Wagon with**  
 13" Flat Free Turf Tires (70290)



**10 Cu Ft Wheelbarrow & Platform with**  
 13" Flat Free Dual Ag Tires (70226)  
 13" Flat Free Single Ag Tires (70080)  
 13" Flat Free Turf Tires (70287)



**9 Cu Ft Wagon with**  
 13" Flat Free Dual Ag Tires (70202)  
 13" Flat Free Single Ag Tires (70079)  
 13" Flat Free Turf Tires (70288)



**C27-20F (70229)** 13" Flat Free Dual Ag Tires



**W46-12T (70176)** Easy Wagon



**W74-PT (70177)** Easy Wagon XT



**C44-13F (70211)** 13" Flat Free Dual Ag Tires



**C44-PSFT (70291)** 13" Flat Free Turf Tires

# CHASSIS PARTS DIAGRAM - STANDARD CARTS

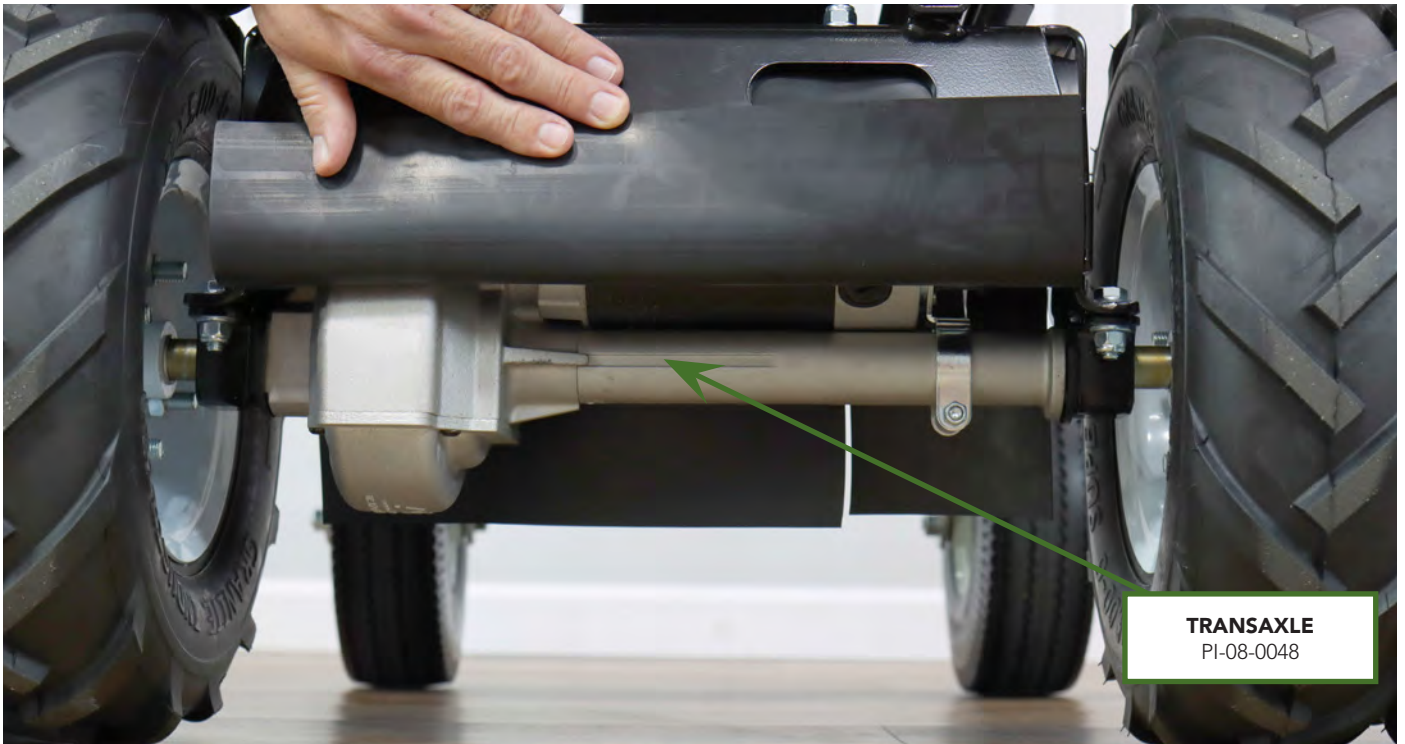

# CHASSIS PARTS DIAGRAM - STANDARD CARTS

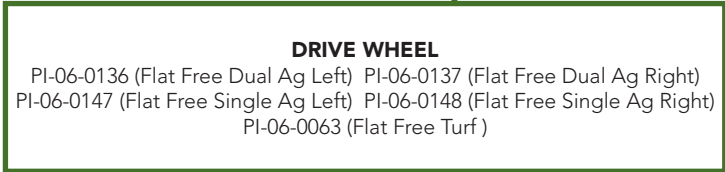
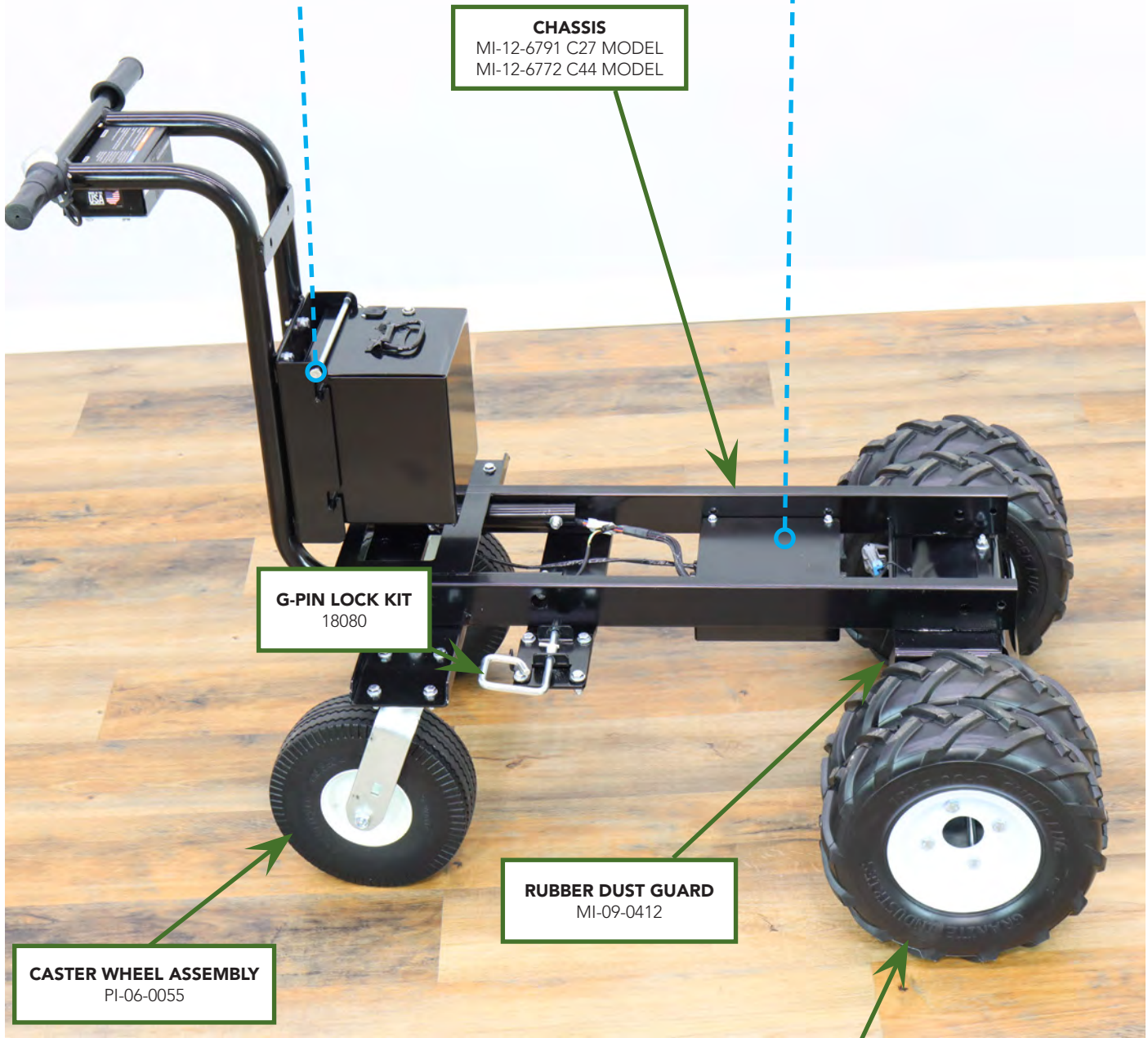
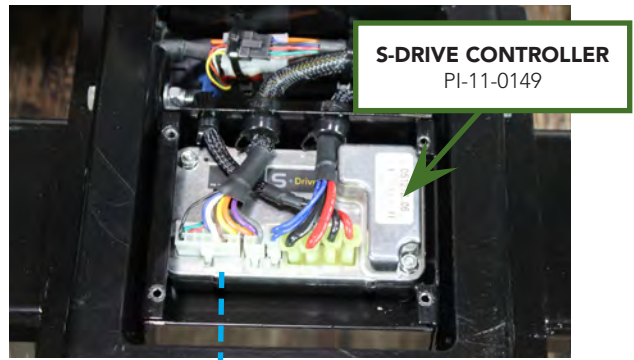
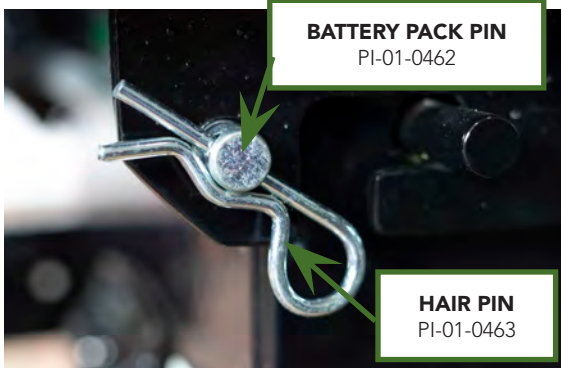



# CHASSIS PARTS DIAGRAM - STANDARD CARTS

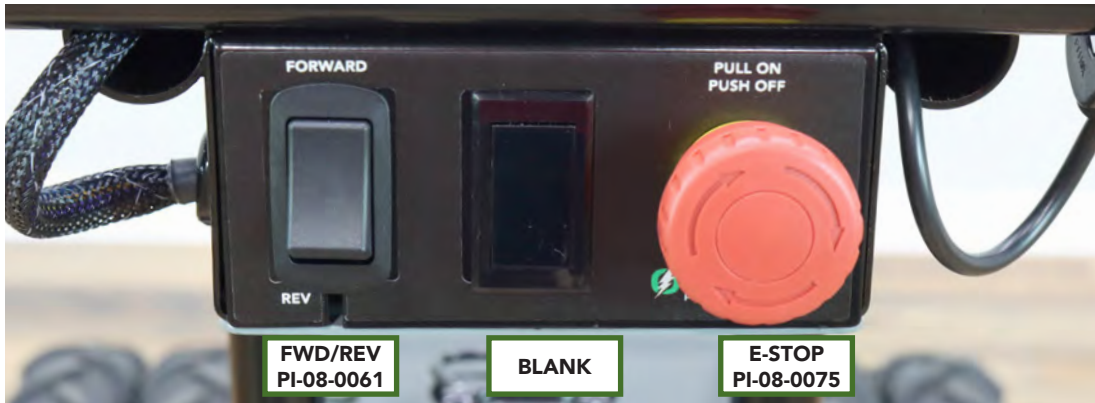

**HANDLE  
CONTROL BOX  
EXTERIOR**

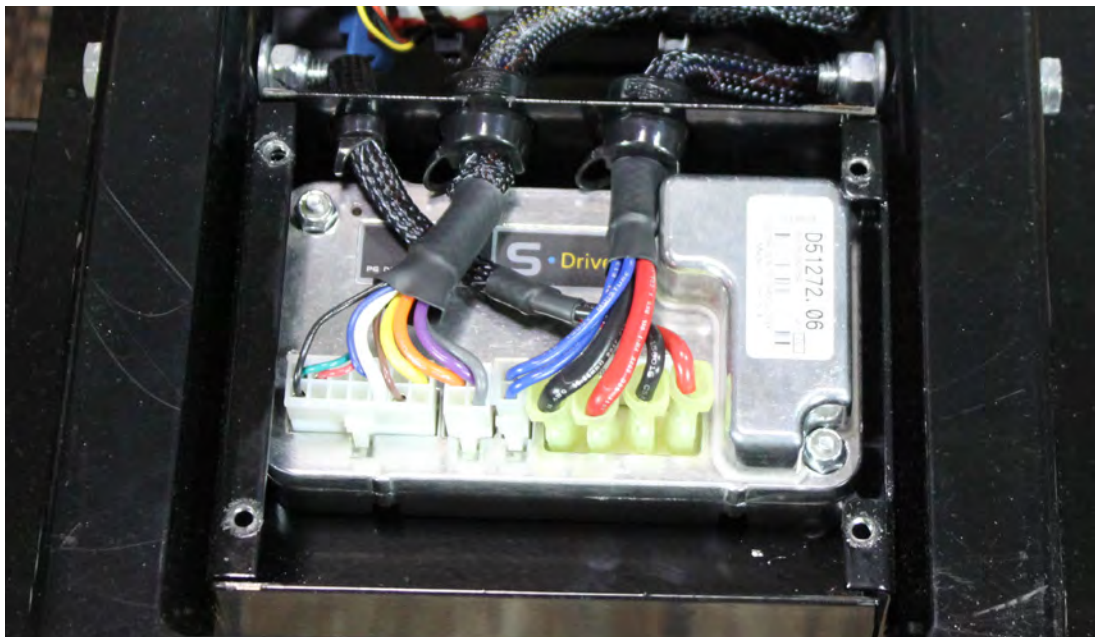
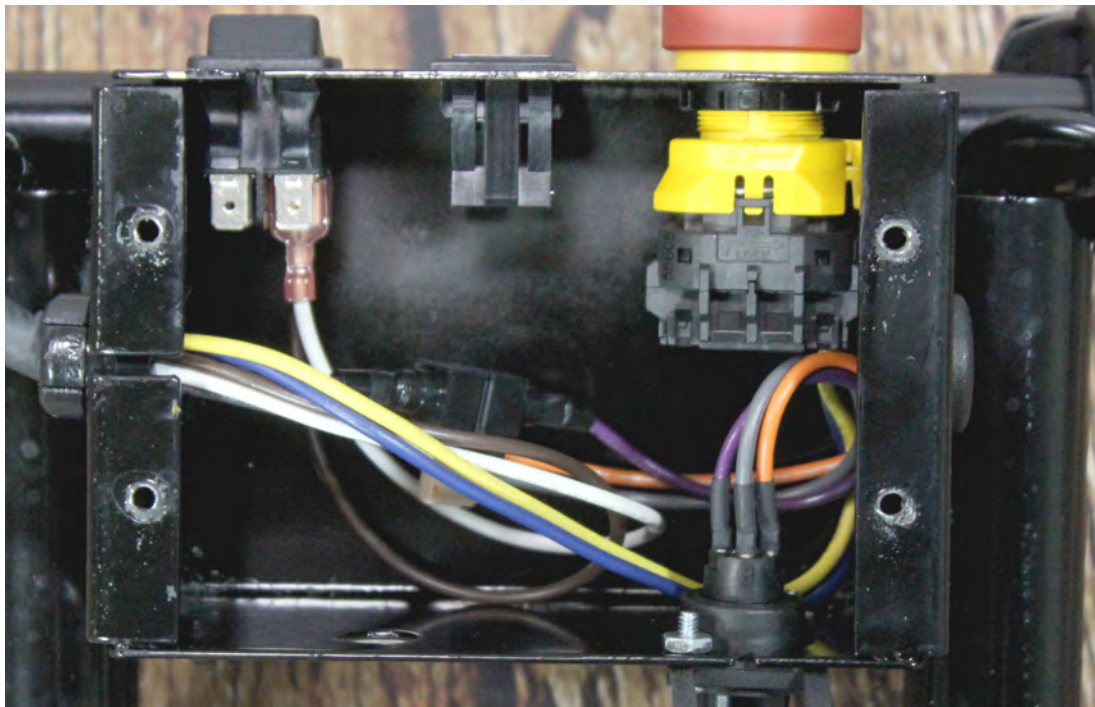

# WIRING DIAGRAM - STANDARD CARTS

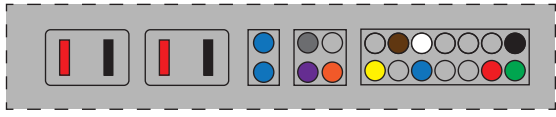

CLOSE UP OF S DRIVE CONNECTIONS

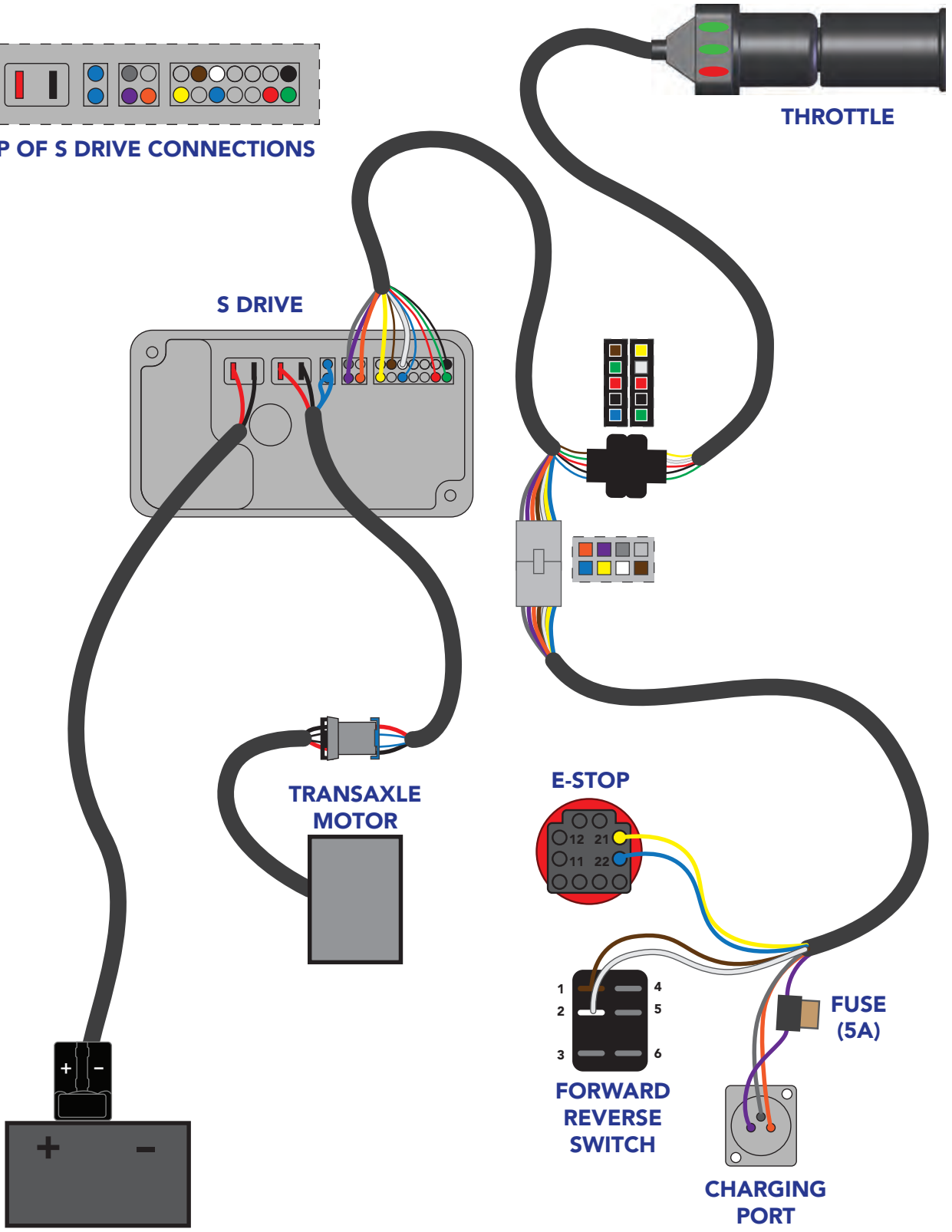

THROTTLE

S DRIVE

TRANSAXLE MOTOR

E-STOP

FORWARD REVERSE SWITCH

FUSE (5A)

CHARGING PORT

## POWER DUMP CARTS

The following pages contain information that relates to the below carts. Although the hopper styles may be different, the parts, chassis and wiring is all the same. The 32 series carts features a power dump option. A powered actuator lifts and dumps the hopper in a controlled manner at the push of a button.



**C32-8FP (70179)**

8 Cu. Ft. Hopper, 13" Flat Free Dual Ag Tires & Power Dump

**C32-10FP (70213)**

10 Cu. Ft. Hopper, 13" Flat Free Dual Ag Tires & Power Dump



**C44-9FP (70260)**

9 Cu. Ft. Hopper, 13" Flat Free Dual Ag Tires & Power Dump

## CHASSIS PARTS DIAGRAM - POWER DUMP CARTS

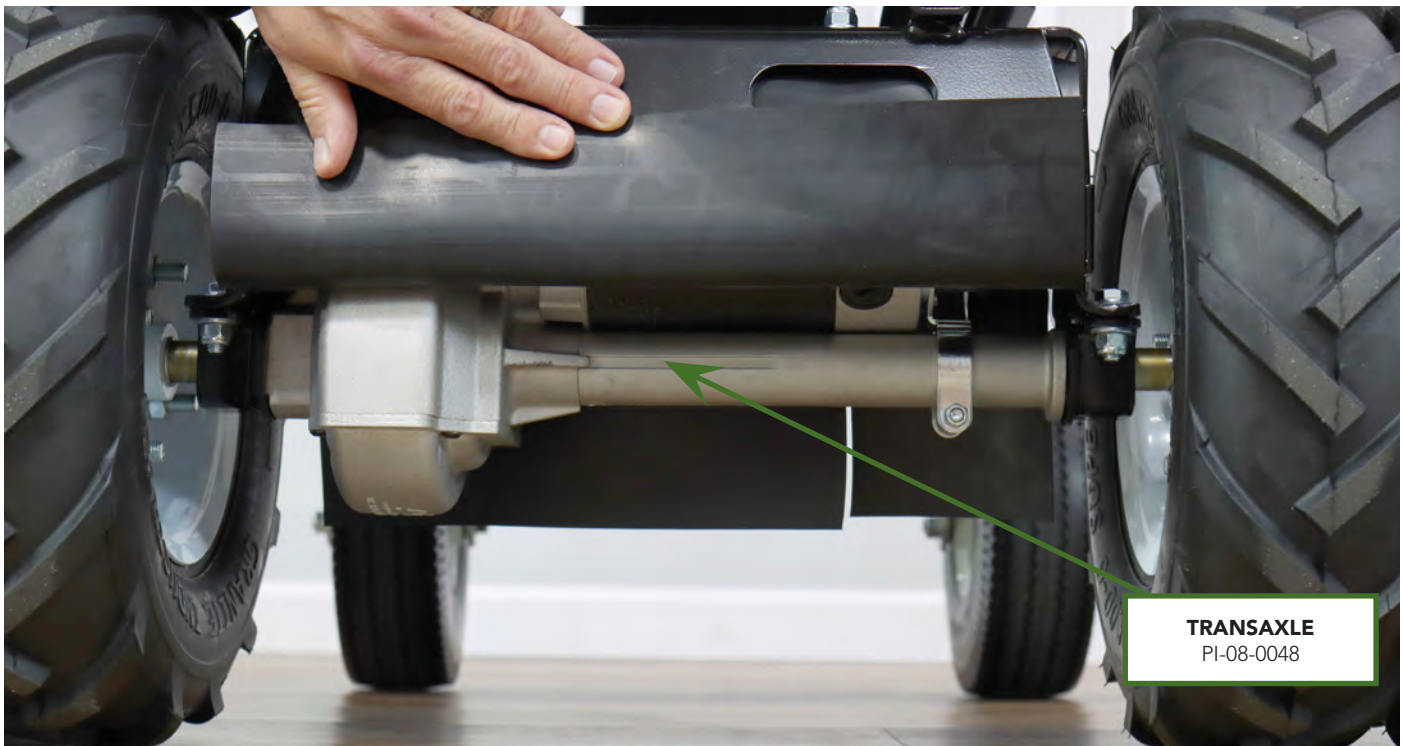
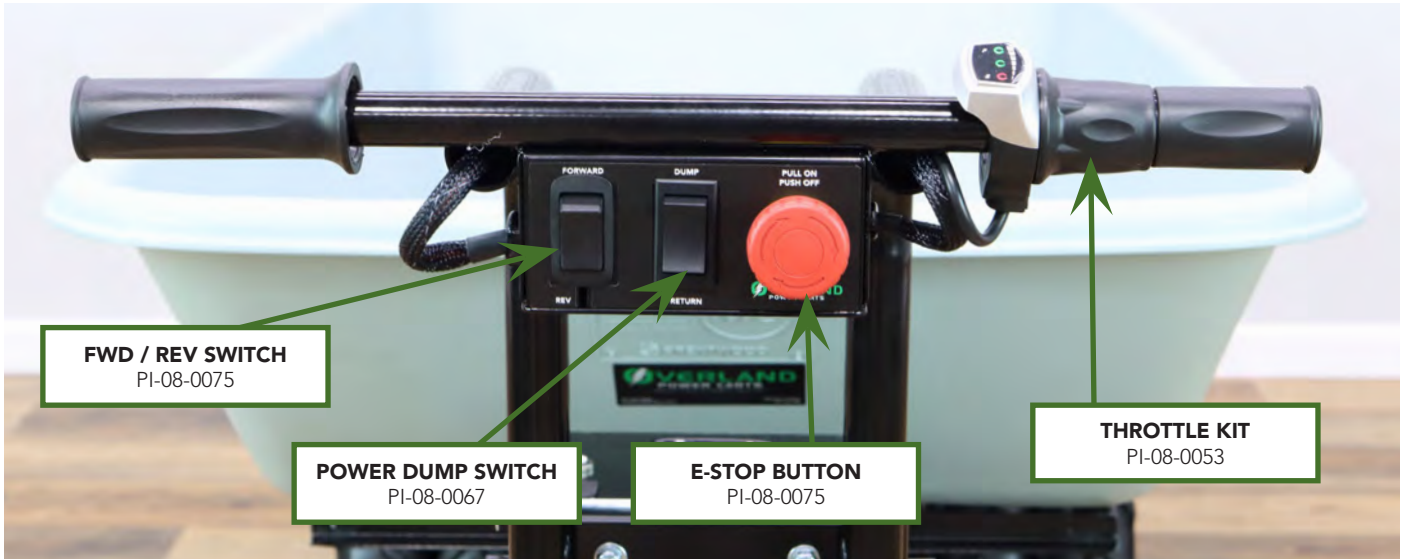

# CHASSIS PARTS DIAGRAM - POWER DUMP CARTS

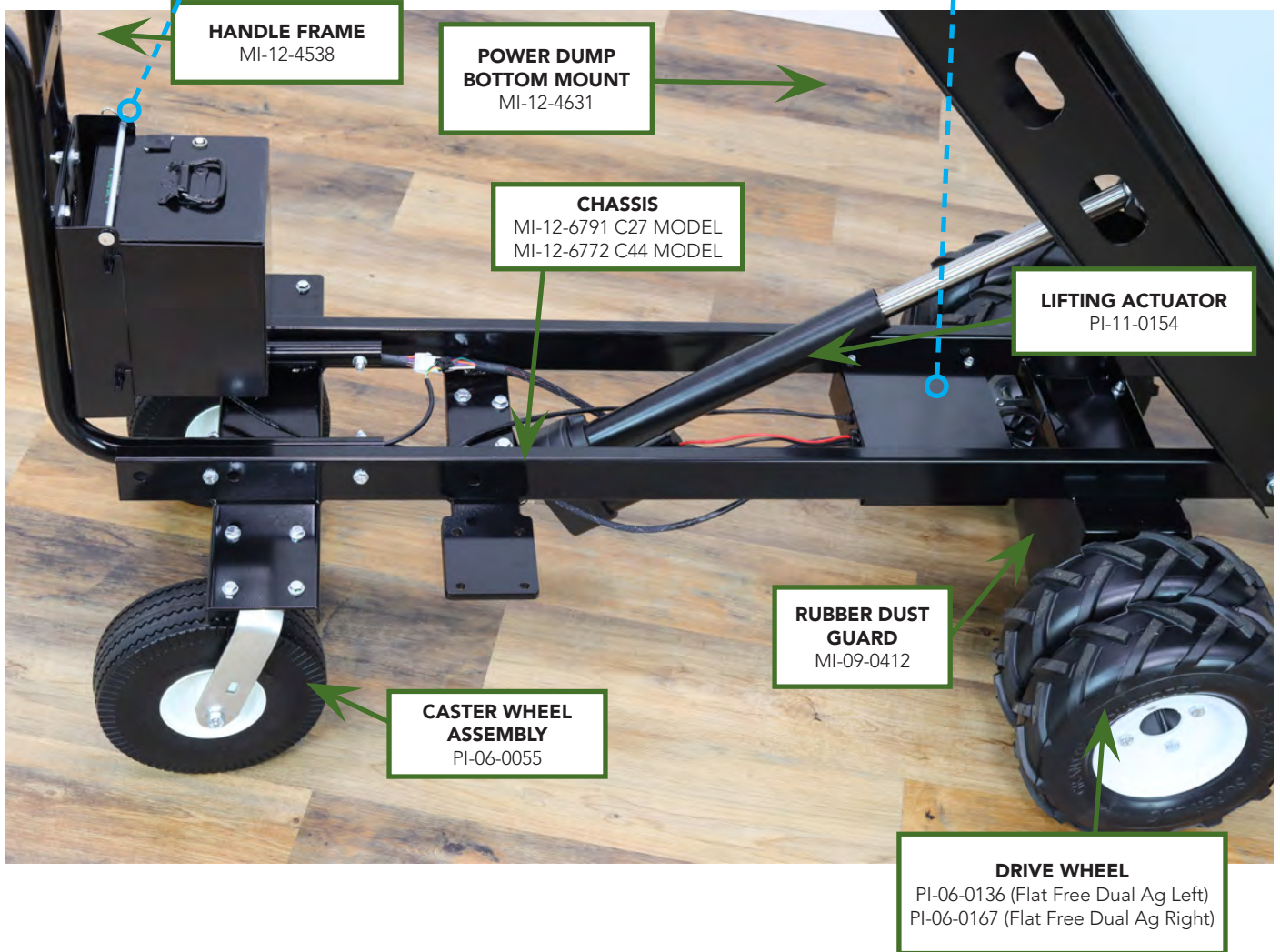
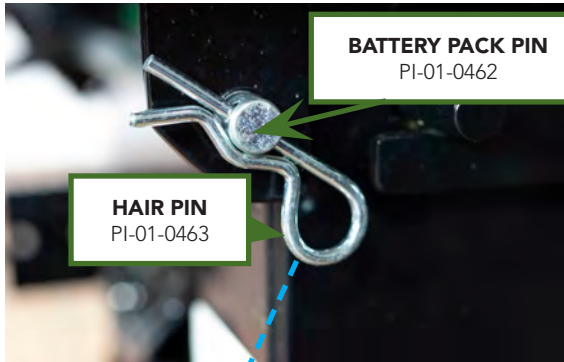

# WIRING DIAGRAM - POWER DUMP CARTS

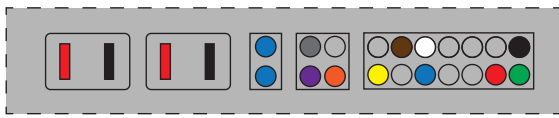

CLOSE UP OF S DRIVE CONNECTIONS

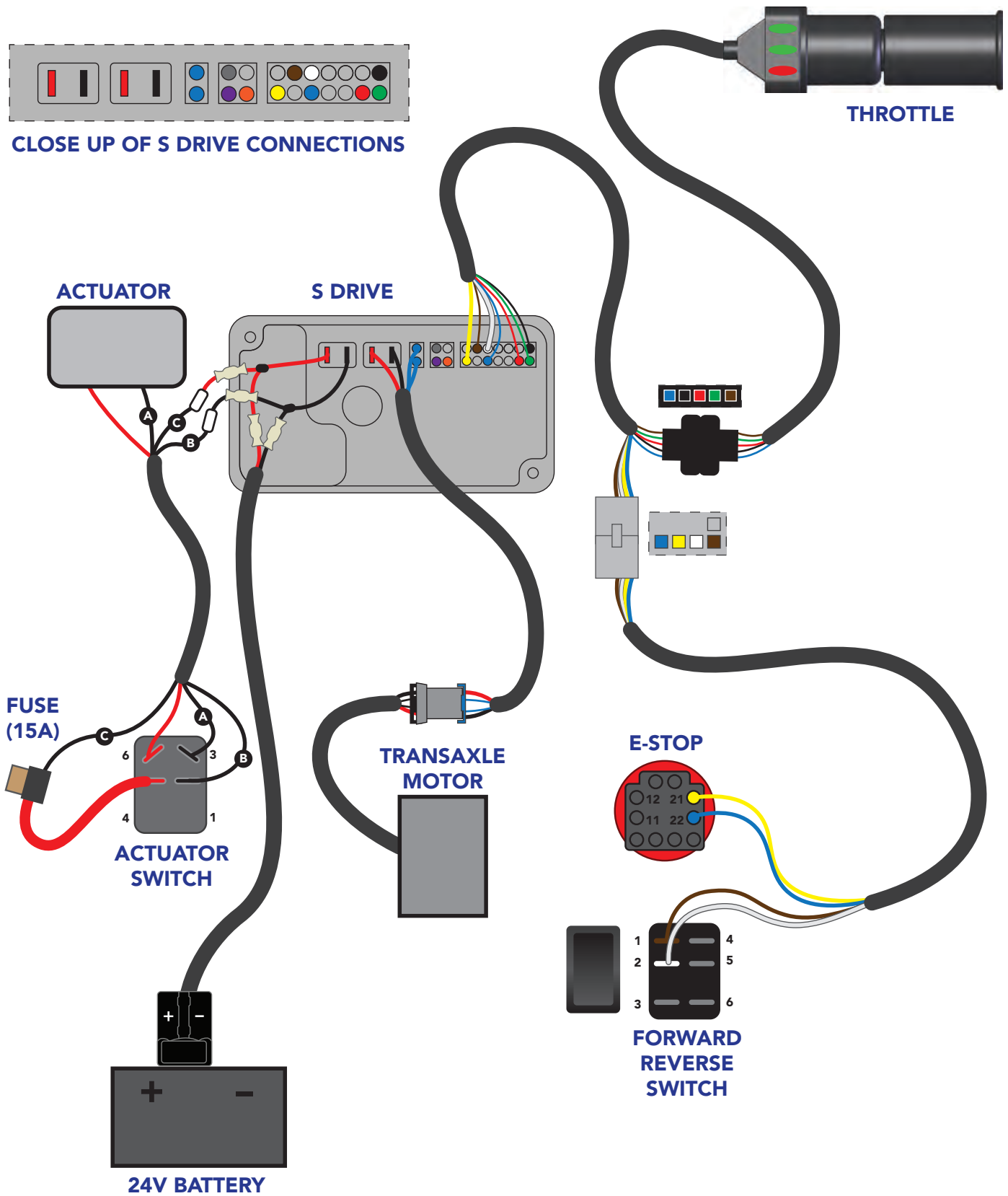

# OVERLAND CART - 400 SERIES REPLACEMENT PARTS



400W Transaxle  
PI-08-0048



24V 22/24AH AGM  
Battery Pack  
(Undermount)  
70124



24V 22/24AH AGM  
Battery Pack  
(Handlemount)  
70348



24V 35/39AH AGM  
Battery Pack  
70171



24V 5A AGM Charger  
PI-11-0191



24V Actuator for  
Power Dump  
PI-11-0154



S Drive 70      S Drive 90  
PI-11-0149      PI-11-0189



30 Amp Circuit Breaker  
PI-08-0045



13" Flat Free Turf Tire  
PI-06-0136



13" Left Flat Free  
Dual Ag Tire  
PI-06-0136



13" Right Flat Free  
Dual Ag Tire  
PI-06-0137



13" Left Flat Free  
Single Ag Tire  
PI-06-0147



13" Right Flat Free  
Single Ag Tire  
PI-06-0148

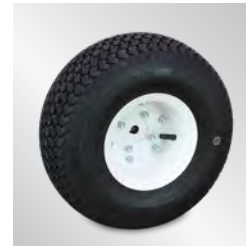

15" Turf Tire  
Drive Wheel PI-06-0131



15" Turf Tire  
Non-Drive Wheel  
PI-06-0142

Part No	Description	Wt	Dimensions
PI-08-0048	400W Transaxle	20 lb	6"H x 6"W x 24"D
70124	24V 22/24AH AGM Battery Pack with 30A Breaker - Undermount	38 lb	8"H x 8"W x 8"D
70348	24V 22/24AH AGM Battery Pack with 30A Breaker - Handle Mount	38 lb	8"H x 8"W x 8"D
70171	24V 35/39AH AGM Battery Pack with 30A Breaker	68 lb	17"H x 9.5"W x 5.5"D
PI-11-0191	24V 5A AGM Charger	2 lb	10' cord
PI-11-0154	24V Actuator for Power Dump	11 lb	6"H x 21"L x 3"D
PI-11-0149	S Drive 70	1 lb	1.5"H x 5"L x 3"D
PI-11-0189	S Drive 90	1 lb	1.5"H x 5"L x 3"D
PI-08-0045	30 Amp Circuit Breaker	1 oz	1.5"H x .5"W x 1.5"D
PI-06-0163	13" Flat Free Turf Tire - 5/8" White Hub	16 lb	13" Diameter - 4"W
PI-06-0136	13" Left Flat Free Dual Ag Tire - 5/8" White Hub*	30 lb	13" Diameter - 8"W
PI-06-0137	13" Right Flat Free Dual Ag Tire - 5/8" White Hub*	30 lb	13" Diameter - 8"W
PI-06-0147	13" Left Flat Free Single Ag Tire - 5/8" White Hub*	16 lb	13" Diameter - 4"W
PI-06-0148	13" Right Flat Free Single Ag Tire - 5/8" White Hub*	16 lb	13" Diameter - 4"W
PI-06-0131	15" Turf Tire Drive Wheel - 5/8" White Hub	12 lb	15" Diameter - 6"W
PI-06-0142	15" Turf Tire Non-Drive Wheel - 5/8" White Hub	9 lb	15" Diameter - 6"W

\*When looking from the front of the cart

# OVERLAND CART - UNIVERSAL REPLACEMENT PARTS



Throttle Kit  
PI-08-0053



Fwd/Rev Switch - OLD  
PI-08-0061



Fwd/Rev Switch - NEW  
PI-08-0145



E-Stop Switch  
PI-08-0075



Power Dump Switch  
PI-08-0067



15 Amp Circuit Breaker  
PI-08-0086



Rear Swivel Caster with  
10" Flat Free Tire  
PI-06-0055



Battery Indicator  
PI-08-0108



22/24A AGM Battery  
PI-11-0215



White Hub for 13"  
Tires - 5/8" ID  
PI-06-0118

Part No	Description	Wt	Dimensions
PI-08-0053	Throttle Kit	8 oz	4' cord
PI-08-0061	Forward/Reverse Switch - OLD	1 oz	1.75"H x 2"W x 1"W
PI-08-0145	Forward/Reverse Switch - NEW	1 oz	1.75"H x 2"W x 1"W
PI-08-0075	E-Stop Switch	2 oz	1.5"H x 3"W x 1.5"D
PI-08-0067	Power Dump Switch	1 oz	1.75"H x 2"W x 1"W
PI-08-0086	15 Amp Circuit Breaker for Power Dump	1 oz	1.5"H x .5"W x 1.5"D
PI-06-0055	Rear Swivel Caster with 10" Flat Free Tire	10 lb	10" Diameter - 3"W
PI-08-0108	Battery Indicator	1 oz	1.25"H x 2.25"W x .5"D
PI-11-0215	22/24A AGM Battery - 12v (2 needed per cart)	13 lb	6.5"H x 7"W x 3"D
PI-11-0262	Green Toolbag for Overland Chargers	1 lb	9.5H x 11"W x 7.5"D
PI-06-0118	White Hub for 13" Tires - 5/8" ID - 400 Series	1 lb	4.5"H x 4.5"W x 2"D

### How do I identify the right and left tires?

Our ag tires have a specific tread pattern and if you ever need to replace a tire, you need to identify them as right or left. To do so, stand in front of your cart, so you are looking at the hopper. The left tire will be on your left side.

