

MAX

SuperSider™

CN565S3

**PNEUMATIC SIDING COIL NAILER
DISPOSITIVO NEUMÁTICO DE CLAVETEADO
DE BOBINA DE TEJADO
CLOUEUR A BOBINE DE TOITURE PNEUMA-
TIQUE**

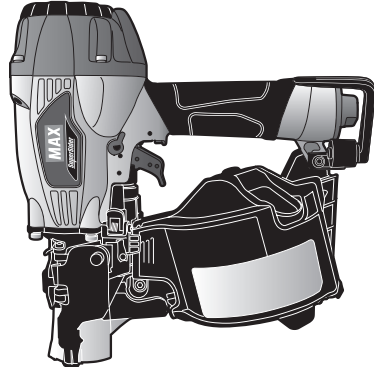

OPERATING AND MAINTENANCE MANUAL MANUEL D'UTILISATION ET D'ENTRETIEN MANUAL DE OPERACIONES Y MANTENIMIENTO



WARNING

**BEFORE USING THIS TOOL, STUDY THIS MANUAL TO ENSURE SAFETY WARNING AND INSTRUCTIONS.
KEEP THESE INSTRUCTIONS WITH THE TOOL FOR FUTURE REFERENCE.**



AVERTISSEMENT

**AVANT D'UTILISER CET OUTIL, LIRE CE MANUEL ET LES CONSIGNES DE SÉCURITÉ AFIN DE GARANTIR UN FONCTIONNEMENT SÛR.
CONSERVER CE MANUEL EN LIEU SÛR AVEC L'OUTIL AFIN DE POUVOIR LE CONSULTER ULTÉRIEUREMENT.**



ADVERTENCIA

**ANTES DE UTILIZAR ESTA HERRAMIENTA, LEA DETENIDAMENTE ESTE MANUAL PARA FAMILIARIZARSE CON LAS ADVERTENCIAS E INSTRUCCIONES DE SEGURIDAD.
CONSERVE ESTAS INSTRUCCIONES JUNTO CON LA HERRAMIENTA PARA FUTURAS CONSULTAS.**

INDEX INDEX ÍNDICE

ENGLISH	Page	3	to	12
FRANÇAIS	Page	13	to	22
ESPAÑOL	Page	23	to	32

DEFINITIONS OF SIGNAL WORDS

- WARNING:** Indicates a hazardous situation which, if not avoided, could result in death or serious injury.
- CAUTION:** Indicates a hazardous situation which, if not avoided, could result in minor or moderate injury.
- NOTICE:** Indicates a property damage message.

DÉFINITIONS DES DIFFÉRENTS DEGRÉS D' AVERTISSEMENTS

- AVERTISSEMENT:** Indique une situation éventuellement dangereuse qui, si elle n'est pas contournée, pourrait provoquer la mort ou des blessures sérieuses.
- ATTENTION:** Indique une situation éventuellement dangereuse qui, si elle n'est pas contournée, pourrait provoquer des blessures légères à moyennement sérieuses.
- REMARQUE:** Souligne des informations importantes.

DEFINICIÓN DE LAS INDICACIONES DE ADVERTENCIA

- ADVERTENCIA:** Indica una situación potencialmente peligrosa que podría causar la muerte o graves lesiones si no se evita.
- PRECAUCIÓN:** Indica una situación potencialmente peligrosa que podría causar lesiones menos graves o leves si no se evita.
- NOTA:** Resalta informaciones importantes.

OPERATING AND MAINTENANCE MANUAL

INDEX

1. GENERAL SAFETY WARNINGS	3
2. SAFETY WARNING	4
3. SPECIFICATIONS AND TECHNICAL DATA	7
4. AIR SUPPLY AND CONNECTIONS.....	7
5. INSTRUCTIONS FOR OPERATION.....	8
6. MAINTAIN FOR PERFORMANCE	12
7. STORING	12
8. TROUBLE SHOOTING/REPAIRS	12



WARNING

BEFORE USING THIS TOOL, STUDY THIS MANUAL TO ENSURE SAFETY WARNING AND INSTRUCTIONS. KEEP THESE INSTRUCTIONS WITH THE TOOL FOR FUTURE REFERENCE.

1. GENERAL SAFETY WARNINGS



WARNING

READ ALL SAFETY WARNINGS AND ALL INSTRUCTIONS.

Failure to follow the warnings and instructions may result in death serious injury. **Save all warnings and instructions for future reference.**



1. WEAR SAFETY GLASSES OR GOGGLES

Danger to the eyes always exists due to the possibility of dust being blown up by the exhausted air or of a fastener flying up due to the improper handling of the tool. For these reasons, safety glasses or goggles shall always be worn when operating the tool.

The employer and/or user must ensure that proper eye protection is worn. Eye protection equipment must conform to the requirements of the American National Standards Institute, ANSI Z87.1 (Council Directive 89/686/EEC of 21 DEC. 1989) and provide both frontal and side protection.

The employer is responsible to enforce the use of eye protection equipment by the tool operator and all other personnel in the work area.

Non-side shielded spectacles and face shields alone do not provide adequate protection.



2. EAR PROTECTION MAY BE REQUIRED IN SOME ENVIRONMENTS

As the working condition may include exposure to high noise levels which can lead to hearing damage, the employer and user should ensure that any necessary hearing protection is provided and used by the operator and others in the work area.



3. KEEP HANDS AND BODY AWAY FROM THE DISCHARGE OUTLET

When loading and using the tool, never place a hand or any part of body in fastener discharge area of the tool. It is very dangerous to hit the hands or body by mistake.



4. DO NOT USE ON SCAFFOLDINGS AND LADDERS

Do not use on scaffoldings and ladders with fastener driving tools equipped with contact actuation or continuous contact actuation.

2. SAFETY WARNING

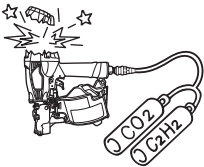

1. DO NOT USE ANY POWER SOURCE EXCEPT AN AIR COMPRESSOR

The tool is designed to operate on compressed air. Do not operate the tool on any other highpressure gas, combustible gases (e.g., oxygen, acetylene, etc.) since there is the danger of an explosion. For this reason, absolutely do not use anything other than an air compressor to operate the tool.



2. OPERATE WITHIN THE PROPER AIR PRESSURE RANGE

The tool is designed to operate within an air pressure range of 70 to 100 p.s.i. (5 to 7 bar).

The pressure should be adjusted to the type of the work being fastened. The tool shall never be operated when the operating pressure exceeds 120 p.s.i. (8.3 bar).

Never connect the tool to air pressure which potentially exceeds 200 p.s.i. (13.8 bar) as the tool can burst.

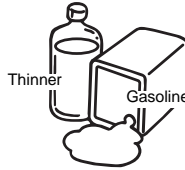

3. DO NOT OPERATE THE TOOL NEAR A FLAMMABLE SUBSTANCE

Never operate the tool near a flammable substance (e.g., thinner, gasoline, etc.). Volatile fumes from these substances could be drawn into the compressor and compressed together with the air and this could result in an explosion.

4. NEVER USE THE TOOL IN AN EXPLOSIVE ATMOSPHERE

Sparks from the tool may ignite atmospheric gases, dust or other combustible materials.

5. DO NOT USE A WRONG FITTINGS

The connector on the tool must not hold pressure when air supply is disconnected. If a wrong fitting is used, the tool can remain charged with air after disconnecting and thus will be able to drive a fastener even after the air line is disconnected, possibly causing injury.



6. DISCONNECT THE AIR SUPPLY AND EMPTY THE MAGAZINE WHEN THE TOOL IS NOT IN USE

Always disconnect the air supply from the tool and empty the magazine when operation has been completed or suspended, when unattended, moving to a different work area, adjusting, disassembling, or repairing the tool, and when clearing a jammed fastener.



7. INSPECT SCREW TIGHTNESS

Loose or improperly installed screws or bolts cause accidents and tool damage when the tool is put into operation. Inspect to confirm that all screws and bolts are tight and properly installed prior to operating the tool.



8. DO NOT TOUCH THE TRIGGER UNLESS YOU INTEND TO DRIVE A FASTENER

Whenever the air supply is connected to the tool, never touch the trigger unless you intend to drive a fastener into the work. It is dangerous to walk around carrying the tool with the trigger pulled, and this and similar actions should be avoided.



9. NEVER POINT THE DISCHARGE OUTLET TOWARD YOURSELF AND OTHER PERSONNEL

If the discharge outlet is pointed toward people, serious accidents may be caused when misfiring. Be sure the discharge outlet is not pointed toward people when connecting and disconnecting the hose, loading and unloading the fasteners or similar operations.

10. USE SPECIFIED FASTENERS (SEE PAGE 7)

The use of fasteners other than specified fasteners will cause the tool malfunction. Be sure to use only specified fasteners when operating the tool.

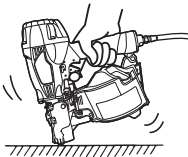

11. PLACE THE DISCHARGE OUTLET ON THE WORK SURFACE PROPERLY

Failure to place the discharge outlet of the nose in a proper manner can result in a fastener flying up and is extremely dangerous.



12. DO NOT DRIVE FASTENERS CLOSE TO THE EDGE AND CORNER OF THE WORK AND THIN MATERIAL

The workpiece is likely to split and the fastener could fly free and hit someone.



13. DO NOT DRIVE FASTENERS ON TOP OF OTHER FASTENERS

Driving fasteners on the top of other fasteners may cause deflection fasteners which could cause injury.

14. REMOVING THE FASTENERS AFTER COMPLETING OPERATION

If fasteners are left in the magazine after the completion of operation, there is the danger of a serious accident occurring prior to the resumption of operation, should the tool be handled carelessly, or when connecting the air fitting. For this reason, always remove all fasteners remaining in the magazine after completion of the operation.

15. CHECK OPERATION OF THE CONTACT TRIP MECHANISM FREQUENTLY IN CASE OF USING A CONTACT TRIP TYPE TOOL

Do not use the tool if the trip is not working correctly as accidental driving of a fastener may result. Do not interfere with the proper operation of the contact trip mechanism.



16. WHEN USING THE TOOL OUTSIDE OR ELEVATED PLACE

When fastening roofs or similar slanted surface, start fastening at the lower part and gradually work your way up. Fastening backward is dangerous as you may lose your foot place. Secure the hose at a point close to the area you are going to drive fasteners. Accidents may be caused due to the hose being pulled inadvertently or getting caught.

17. NEVER USE THE TOOL IF ANY PORTION OF THE TOOL CONTROLS (e.g., TRIGGER, CONTACT ARM) IS INOPERABLE, DISCONNECTED, ALTERED OR NOT WORKING PROPERLY

18. NEVER ACTUATE THE TOOL INTO FREE SPACE

This will avoid any hazard caused by free flying fasteners and excessive strain of the tool.

19. ALWAYS ASSUME THAT THE TOOL CONTAINS FASTENERS

20. RESPECT THE TOOL AS A WORKING IMPLEMENT

21. NO HORSEPLAY

22. NEVER LOAD THE TOOL WITH FASTENERS WHEN ANY ONE OF THE OPERATING CONTROLS (e.g., TRIGGER, CONTACT ARM) IS ACTIVATED

23. WHEN DISPOSING THE MACHINE OR ITS PARTS, FOLLOW THE RELEVANT NATIONAL RULES

OBSERVE THE FOLLOWING GENERAL CAUTION IN ADDITION TO THE OTHER WARNINGS CONTAINED IN THIS MANUAL

- Always wear head protection, safety shoes and mask when using the tool.
- Do not use the tool as a hammer.
- Always carry the tool by the grip, never carry the tool by the air hose.
- The tool must be used only for the purpose it was designed.
- Never remove, tamper with the operating controls (e.g., TRIGGER, CONTACT ARM)
- Keep the tool in a dry place out of reach of children when not in use.
- Do not use the tool without Safety Warning label.
- Do not modify the tool from original design or function without approval by MAX CO., LTD.

3. SPECIFICATIONS AND TECHNICAL DATA

1. NAME OF PARTS

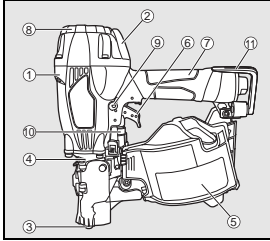

- ① Frame
- ② Cylinder Cap
- ③ Contact Arm
- ④ Nose
- ⑤ Magazine
- ⑥ Trigger
- ⑦ Grip
- ⑧ Exhaust Port
- ⑨ Trigger Lock Dial
- ⑩ Adjustment Dial
- ⑪ Hook

2. TOOL SPECIFICATIONS

HEIGHT	11-7/8" (302 mm)
WIDTH	5" (127 mm)
LENGTH	10-7/8" (275 mm)
WEIGHT	5.2 lbs. (2.4 kg)
RECOMMENDED OPERATING PRESSURE	70 to 100 p.s.i. (5 to 7 bar)
LOADING CAPACITY	400 Nails
AIR CONSUMPTION	0.05 ft ³ at 100 p.s.i. (1.55 l at 7 bar) operating pressure

3. FASTENER SPECIFICATIONS

Collation type	15 degree flat wire welded coil nails	15 degree flat plastic collated coil nails
Shank type	Smooth Screw Ring	Smooth Screw Ring
Nail length	1-1/2" to 2-1/2" (38 mm to 65 mm)	1-1/4" to 2-1/2" (32 mm to 65 mm)
Shank diameter	.083" to .099" (2.1 mm to 2.5 mm)	.083" to .099" (2.1 mm to 2.5 mm)
Head diameter	.197" to .236" (5.0 mm to 6.0 mm)	.197" to .236" (5.0 mm to 6.0 mm)

TOOL AIR FITTINGS:

This tool uses a 1/4" N.P.T. male plug. The inside diameter should be .28" (7 mm) or larger. The fitting must be capable of discharging tool air pressure when disconnected from the air supply.

RECOMMENDED OPERATING PRESSURE:

70 to 100 p.s.i. (5 to 7 bar). Select the operating air pressure within this range for best fastener performance.

DO NOT EXCEED 120 p.s.i. (8 bar).

4. TECHNICAL DATA

● NOISE

A-weighted single-event sound power level
----- LWA, 1s, d 93.1 dB
A-weighted single-event emission sound pressure level at work station
----- LpA, 1s, d 89.3 dB

These values are determined and documented in accordance to EN12549 : 1999.

● VIBRATION

Vibration characteristic value = 4.4 m/s²
These values are determined and documented in accordance to ISO 8662-11.

This value is a tool-related characteristic value and does not represent the influence to the hand-arm-system when using the tool. An influence to the hand-arm-system when using the tool will for example depend on the gripping force, the contact pressure force, the working direction, the adjustment of mains supply, the workpiece, the workpiece support.

5. APPLICATIONS

- * Siding (Hardboard and Cement)
- * Sheathing
- * Fencing
- * Subflooring
- * Roof decking
- * Exterior deck
- * Exterior trim
- * Furring
- * Strapping

4. AIR SUPPLY AND CONNECTIONS



WARNING

Read section titled "SAFETY INSTRUCTIONS"

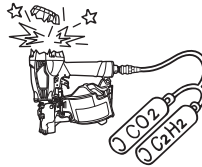

DO NOT USE ANY POWER SOURCE EXCEPT AN AIR COMPRESSOR

The tool is designed to operate on compressed air. Do not operate the tool on any other high pressure gas, combustible gases (e.g., oxygen, acetylene, etc.) since there is the danger of an explosion. For this reason, absolutely do not use anything other than an air compressor to operate the tool.



OPERATE WITHIN THE PROPER AIR PRESSURE RANGE

The tool designed to operate within an air pressure range of 70 to 100 p.s.i. (5 to 7 bar)

The pressure should be adjusted to the type of the work being fastened. The tool shall never be operated when the operating pressure exceeds 120 p.s.i. (8 bar)

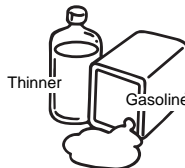

DO NOT OPERATE THE TOOL NEAR A FLAMMABLE SUBSTANCE

Never operate the tool near a flammable substance (e.g., thinner, gasoline, etc.). Volatile fumes from these substances could be drawn into the compressor and compressed together with the air and this could result in an explosion.

DO NOT USE A WRONG FITTINGS

The connector on the tool must not hold pressure when air supply is disconnected. If a wrong fitting is used, the tool can remain charged with air after disconnecting and thus will be able to drive a fastener even after the air line is disconnected, possibly causing injury.



DISCONNECT THE AIR SUPPLY AND EMPTY THE MAGAZINE WHEN THE TOOL IS NOT IN USE

Always disconnect the air supply from the tool and empty the magazine when operation has been completed or suspended, when unattended, moving to a different work area, adjusting, disassembling, or repairing the tool, and when clearing a jammed fastener.

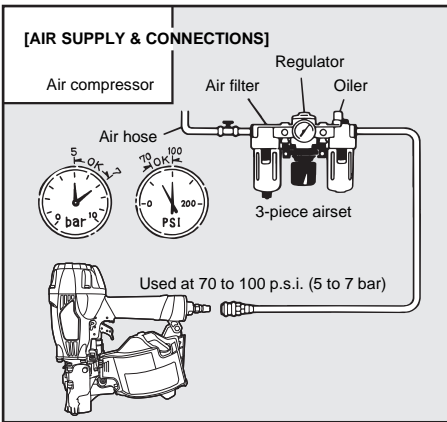

FITTINGS: Install a male plug on the tool which is free flowing and which will release air pressure from the tool when disconnected from the supply source.

HOSES: The hose has a min. ID of 1/4" (6 mm) and a max. length of no more than 17' (5 meters) from the 3-piece airset and 98' (30 meters) from the air compressor.

The supply hose should contain a fitting that will provide "quick disconnecting" from the male plug on the tool.

SUPPLY SOURCE: Use only clean regulated compressed air as a power source for the tool.

3-PIECE AIRSET (Air filter, Regulator, Oiler):

Refer to TOOL SPECIFICATIONS for setting the correct operating pressure for the tool.

NOTICE:

A filter will help to get the best performance and minimum wear from the tool because dirt and water in the air supply are major causes of wear in the tool.

Frequent, but not excessive, lubrication is required for the best performance. Oil added thru the air line connection will lubricate the internal parts.

5. INSTRUCTIONS FOR OPERATION

Read section titled "SAFETY INSTRUCTIONS".

1. BEFORE OPERATION

Check the following prior operation.

- ① Wear Safety Glasses or Goggles.
- ② Do not connect the air supply.
- ③ Inspect screw tightness.
- ④ Check operation of the contact arm & trigger if moving smoothly.
- ⑤ Connect the air supply.
- ⑥ Check the air-leakage. (The Tool must not have the air-leakage.)
- ⑦ Hold the Tool with finger-off the trigger, then push the contact arm against the work-piece. (The tool must not operate.)
- ⑧ Hold the Tool with contact arm free from work-piece and pull the trigger. (The Tool must not operate.)
- ⑨ Disconnect the air supply.



WARNING



2. OPERATION

Wear safety glasses or goggles danger to the eyes always exists due to the possibility of dust being blown up by the exhausted air or of a fastener flying up due to the improper handling of the tool.

For these reasons, safety glasses or goggles shall always be worn when operating the tool.

The employer and/or user must ensure that proper eye protection is worn. Eye protection equipment must conform to the requirements of the American National Standards Institute, ANSI Z87.1 (Council Directive 89/686/EEC of 21 DEC. 1989) and provide both frontal and side protection.

The employer is responsible to enforce the use of eye protection equipment by the tool operator and all other personnel in the work area.

Non-side shielded spectacles and face shields alone do not provide adequate protection.



WARNING



Keep hands and body away from the discharge outlet when driving the fasteners because of dangerous of hitting the hands or body by mistake.

NAIL LOADING

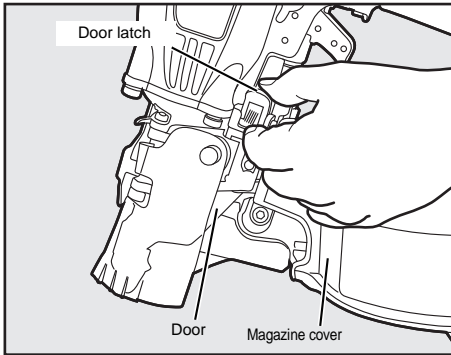

WARNING

- **ALWAYS disconnect air supply before nail loading.**

- ① Open the magazine:
Take hold of the door and of the door latch with your fingers. Pull up the door latch and swing the door open. Swing the magazine cover open.

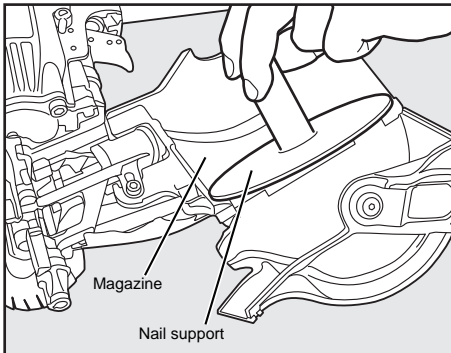

- ② Check adjustment:
The nail support can be moved up and down to four settings. The nail support moves down by turning it counter-clockwise and moves up by turning it clockwise. The nail support should be adjusted correctly to the position as follows;
2-1/4" to 2-1/2" (57 to 65 mm) nails - use bottom step
2" (50 mm) nails - use second step
1-5/8" to 1-3/4" (40 to 45 mm) nails - use third step
1-1/4" to 1-1/2" (32 to 38 mm) nails - use top step

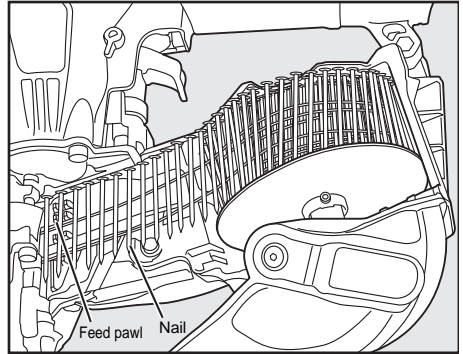

- ③ Nail loading:
Place a coil of nails over the post in the Magazine. Uncoil enough nails to reach the Feed Pawl, and place the second nail between the teeth on the Feed Pawl. The nail heads fit in slot on nose.

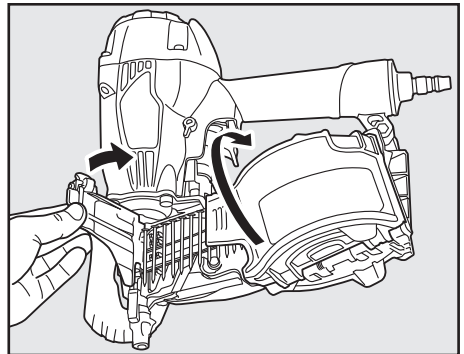

- ④ Swing Cover closed.
- ⑤ Close the Door.
Check that latch engages. (If it does not engage, check that the nail heads are in the slot on the Nose.)

TEST OPERATION

- ① Adjust the air pressure at 70 p.s.i. (5 bar) and connect the air supply.
- ② Without touching the Trigger, depress the Contact Arm against the work-piece.
Pull the Trigger. (The tool must fire the fastener.)
- ③ With the tool off the work-piece, pull the Trigger.
Then depress the Contact Arm against the work-piece. (The tool must fire the fastener.)
- ④ Adjust the air pressure as much as the lowest possible according to the diameters and length of fastener and the hardness of work-piece.

DRIVING DEPTH ADJUSTMENT DIAL

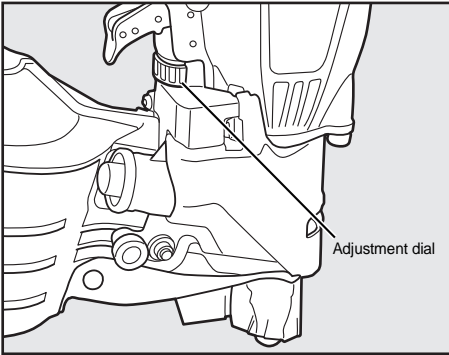

WARNING

- **ALWAYS** disconnect air supply before Adjust-ment dial.

- ① With air pressure set, drive nails into a representative material sample to determine if adjustment is necessary.
- ② If adjustment is required, disconnect air supply.
- ③ Refer to the mark on the Contact Arm area for direction to turn the Adjustment dial.

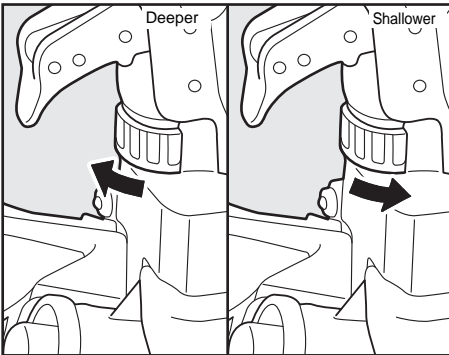

- ④ Reconnect air supply.

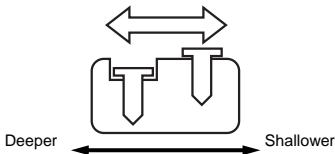

TRIGGER LOCK MECHANISM

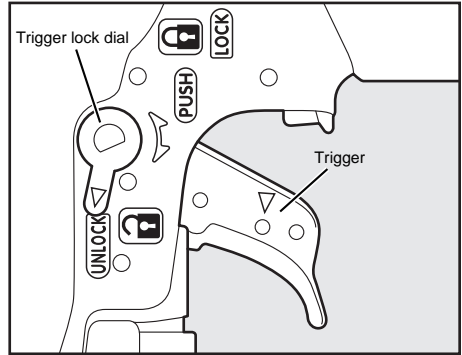

The tool is equipped with a trigger lock mechanism. Push and rotate the Trigger Lock Dial to the trigger free position before driving nails.

DIRECTIONAL EXHAUST COVER

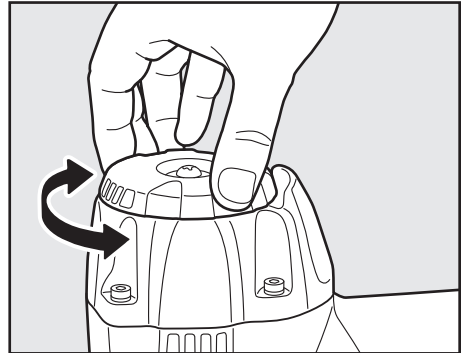

WARNING

- **ALWAYS** disconnect air supply before rotating the exhaust cover.

Direction of the exhaust air is changeable by rotating exhaust cover by hand.

CHANGING THE HOOK DIRECTION

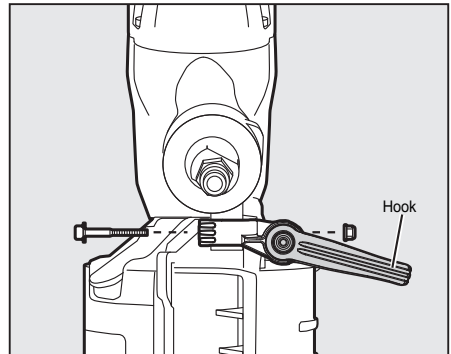



WARNING

- **ALWAYS disconnect air supply before changing the hook direction.**

The hook can be directed in the two direction. Remove the hexagon socket cap screw with hexagon wrench, change the direction, and then, put back the bolt to reassemble.

HOW TO REMOVE USED PLASTIC SHEET COLLATION

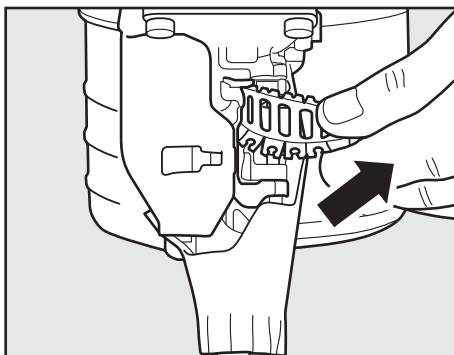

As nails are driven the plastic sheet will feed out of the tool. When two inches or more has been fed out it can be torn away by pulling against the tear edge in the nose.

HOW TO REATTACH THE REMOVABLE "CONTACT NOSE".



WARNING

- **ALWAYS disconnect air supply before reassembling the contact nose.**

- ① Lock the Trigger and turn the depth adjust dial to the shallowest position.

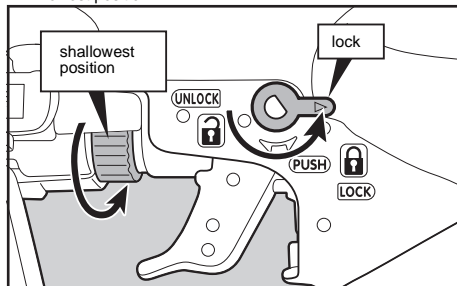

- ② Align the Contact Nose to the parts pointed by the arrows.

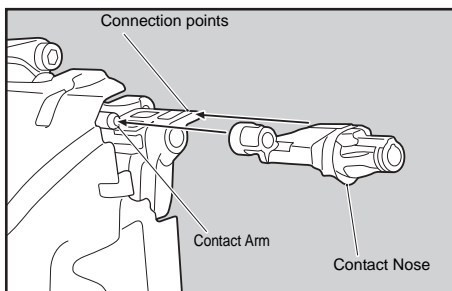
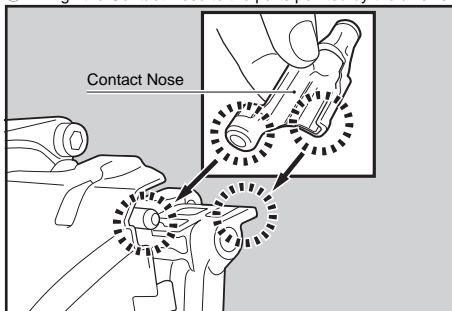

- ③ With a Flathead screwdriver (see A) or manually (see B), push the Contact Nose at the place indicated below until it clicks.

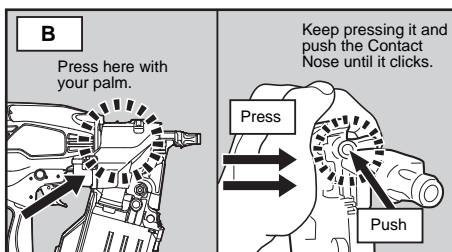
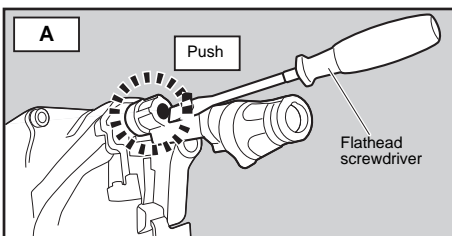
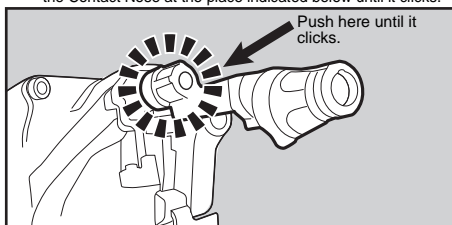

The tip of the rod must be seen like this after the reassembly is done.

If not, try again from step 2.

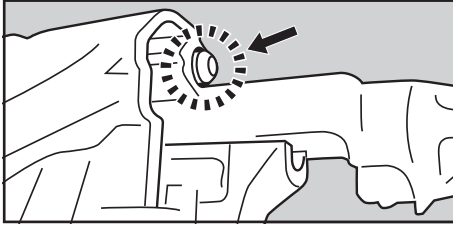

MODEL IDENTIFICATION

CONTACT TRIP WITH ANTI-DOUBLE FIRE MECHANISM (US patent 5597106, UK patent 2286790)

The common operating procedure on "Contact Trip" tools is for the operator to contact the work to actuate the trip mechanism while keeping the trigger pulled, thus driving a fastener each time the work is contacted. This will allow rapid fastener placement on many jobs, such as sheathing, decking and pallet assembly. All pneumatic tools are subject to recoil when driving fasteners. The tool may bounce, releasing the trip, and if unintentionally allowed to recontact the work surface with the trigger still actuated (finger still holding trigger pulled) an unwanted second fastener will be driven.

CONTACT TRIP WITH ANTI-DOUBLE FIRE MECHANISM Identified by RED TRIGGER.

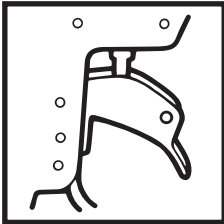

CONTACT FIRE OPERATION

For contact fire operation, hold the Trigger and depress the Contact Arm against the work surface.

SINGLE FIRE OPERATION (ANTI-DOUBLE FIRE MECHANISM)

For single fire operation, depress the Contact Arm against the work surface and pull the Trigger.
Tool cannot fire a second nail until the Trigger is released and tool can cycle.

SEQUENTIAL TRIP

Identified by ORANGE TRIGGER.

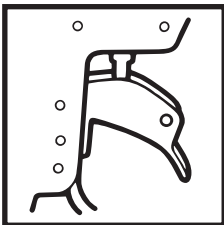

CONTACT TRIP WITH ANTI-DOUBLE FIRE MECHANISM (Optional kit)

(US patent 5597106, UK patent 2286790)

The common operating procedure on "Contact Trip" tools is for the operator to contact the work to actuate the trip mechanism

while keeping the trigger pulled, thus driving a fastener each time the work is contacted. This will allow rapid fastener placement on many jobs, such as sheathing, decking and pallet assembly. All pneumatic tools are subject to recoil when driving fasteners. The tool may bounce, releasing the trip, and if unintentionally allowed to recontact the work surface with the trigger still actuated (finger still holding trigger pulled) an unwanted second fastener will be driven.

6. MAINTAIN FOR PERFORMANCE

❶ DO NOT FIRE THE NAILER WHEN IT IS EMPTY

❷ USE A 3-PIECE AIRSET

Failure to use a 3-piece airset allows the moisture and dirt inside compressor to pass into the tool directly. This causes rust and wear, and results in a poor operating performance. The hose length between airset and tool should be no longer than 5 m since a longer length results in a reduction in air pressure.

❸ USE RECOMMENDED OIL

The velocite or turbine oil should be used to lubricate the tool. Upon completion of operations, place 2 or 3 drops of oil into the Air Plug inlet with the jet oiler. (Recommended Oil : ISO VG32)

❹ INSPECT AND MAINTAIN DAILY OR BEFORE OPERATION



WARNING

Disconnect air supply and empty the Magazine when inspecting or maintaining the tool.

- (1) Drain air line filter and compressor
- (2) Keep lubricator filled in air 3-pieces set
- (3) Clean filter element of air 3-pieces set
- (4) Tighten all screws
- (5) Keep Contact Arm moving smoothly

7. STORING

- ❶ When not in use for an extended period, apply a thin coat of the lubricant to the steel parts to avoid rust.
- ❷ Do not store the tool in a cold weather environment. Keep the tool in a warm area.
- ❸ When not in use, the tool should be stored in a warm and dry place. Keep out of reach of children.
- ❹ All quality tools will eventually require servicing or replacement of parts because of wear from the normal use.

8. TROUBLE SHOOTING/REPAIRS

The troubleshooting and/or repairs shall be carried out only by the MAX CO., LTD. authorised distributors or by other specialists.

- The content of this manual might be changed without notice for improvement.
 - Le contenu de ce manuel est sujet a modification sans preavis a des fins d'amelioration.
 - El contenido de este manual puede ser cambiado sin noticia previa para mejoramiento.
-
- The specifications and design of the products in this manual will be subject to change without advance notice due to our continuous efforts to improve the quality of our products.
 - Les caracteristiques et la conception des produits mentionnes dans ce manuel sont sujettes a des modifications sans preavis en raison de nos efforts continus pour ameliorer la qualite de nos produits.
 - Las caracteristicas y la concepcion de los productos mencionados en este manual estan sujetas a modificaciones sin preaviso debido a nuestros esfuerzos continuos para mejorar la calidad de nuestros productos.



MAX USA CORP.
257 East 2nd Street
Mineola, NY 11501, U.S.A.
TEL: 1-800-223-4293
FAX: (516)741-3272

www.maxusacorp.com (USA Site)
wis.max-ltd.co.jp/int/ (GLOBAL Site)



4100367
160511-00/02

