

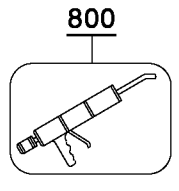

Click Here To View  
Item at

[www.GapPower.com](http://www.GapPower.com)

*Sales • Rentals  
Parts & Service*

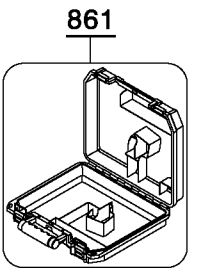
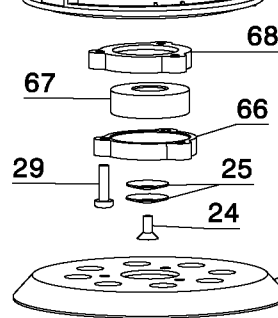
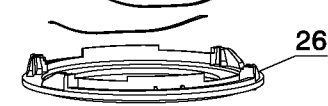
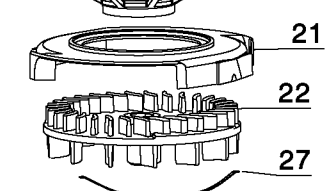
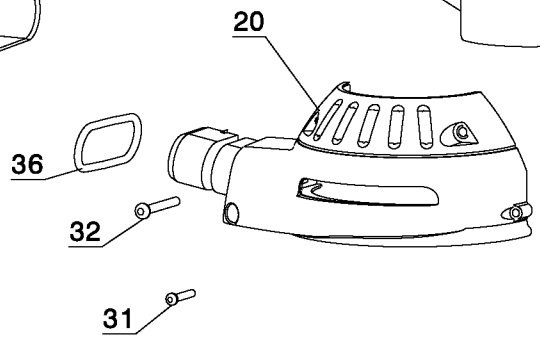
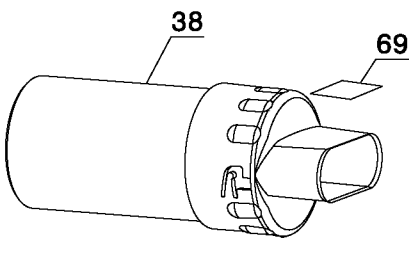
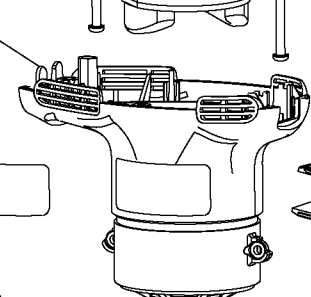
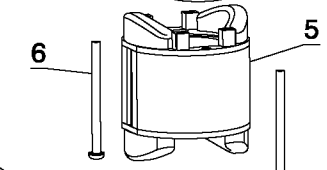
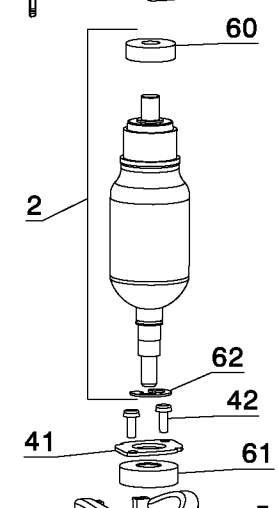
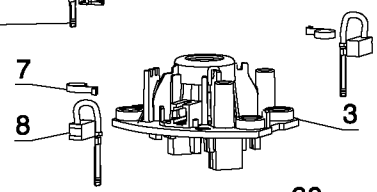
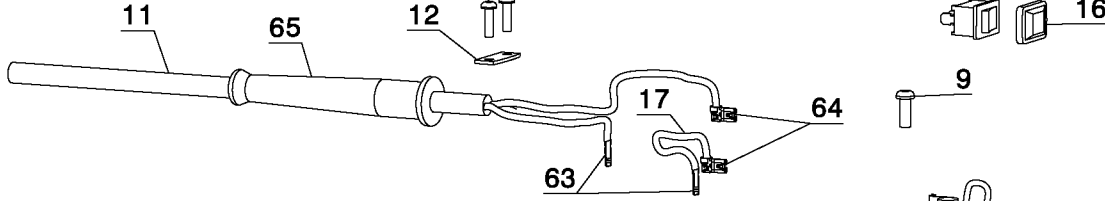

## Parts List for D26451K Type 1

Item Number	Part Number	Description	Qty Required
1	623832-00	FIELD CASE	1
2	624309-00SV	ARMATURE & BRGS	1
3	627401-00SV	BEARING SUPPORT	1
5	624277-00SV	FIELD	1
6	330019-09	SCREW	2
7	445860-00	SPRING,BRUSH	2
8	445861-20	BRUSH	2
9	330019-11	SCREW	4
11	330072-98	CORD/8FT/18-2SJ	1
12	329301-00	CLAMP,CORD	1
13	330019-02	SCREW,PLASTITE	2
14	144960-00	SWITCH (ON-OFF)	1
16	144983-07	COVER,SWITCH	1
17	144989-00	LEAD ASSY.	1
19	624281-00	CAP	1
20	628817-00	SHROUD	1
21	624240-00	FAN BAFFLE	1
22	624235-01	FAN	1
24	098012-11	MACH SCREW	1
25	151652-00	WASHER,CONE	2
26	624302-00	BRAKE	1
27	151442-02	SPRING	2
28	DW4388	PAD	1
28	151281-08	PAD	1
29	146929-01	SCREW	3
31	330019-24	SCREW	1
32	330019-59	SCREW	3

COPYRIGHT© 2005. All Rights Reserved.

Parts list, pricing, and availability subject to change. Please visit [www.dewaltservicenet.com](http://www.dewaltservicenet.com) for current parts information.

## Parts List for D26451K Type 1

Item Number	Part Number	Description	Qty Required
34	398399-00	IDENT. LABEL	1
35	649793-00	NAMEPLATE	1
36	56194-00	RING,O	1
38	624307-00	DUST BAG ASSY	1
41	632116-00	BEARING RETAINER	1
42	330019-01	SCREW,TORX HD	2
60	330003-03	BEARING,BALL	1
61	330003-17	BEARING,BALL	1
62	151669-00	RING,RETAINING	1
63	825209-00	TERMINAL	2
64	445964-00	RECEPTACLE	2
65	330005-01	PROTECTOR,CORD	1
66	603637-00	BRG. RETAINER	1
67	330003-75	BEARING, BALL	1
68	603664-00	BRG. RETAINER	1
69	624299-00	WARNING LABEL	1
800	761995-01	GREASE, 6 OZ.	1
800	283484-01	GREASE,32 OZ.	1
861	N041318	TOOL BAG	1
861	625383-00	KIT BOX	1

COPYRIGHT© 2005. All Rights Reserved.

Parts list, pricing, and availability subject to change. Please visit [www.dewaltservicenet.com](http://www.dewaltservicenet.com) for current parts information.